



# OM 502

---

5 DIGIT  
PROGRAMMABLE INSTRUMENT

DC VOLTMETER/AMMETER

PROCESS MONITOR

INTEGRATOR

LINEARIZATORR

DISPLAYS FOR LIN. POTENTIOMETERS

DISPLAY INSTRUMENT FOR TENSIOMETER

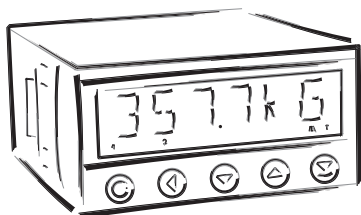

## SAFETY INSTRUCTIONS

Please, read the enclosed safety instructions carefully and observe them!  
These instruments should be safeguarded by isolated or common fuses (breakers)!  
For safety information the EN 61 010-1 + A2 standard must be observed.  
This instrument is not explosion-safe!

## TECHNICAL DATA

Measuring instruments of the OM 502 series conform to the European regulation 89/336/EWG and the Ordinance 168/1997 Coll.

The instruments are up to the following European standards:

EN 55 022, class B

EN 61000-4-2, -4, -5, -6, -8, -9, -10, -11

The instruments are applicable for unlimited use in agricultural and industrial areas.

## CONNECTION

Supply of energy from the main line has to be isolated from the measuring leads.



### ORBIT MERRET, spol. s r.o.

Vodnanská 675/30

198 00 Prague 9

Czech Republic

Tel: +420 - 281 040 200

Fax: +420 - 281 040 299

e-mail: orbit@merret.cz

www.orbit.merret.cz



1.	Contents	3
2.	Instrument description	4
3.	Instrument connection	6
4.	Instrument setting	8
	Symbols used in the instructions	10
	Setting the DP and the (-) sign	10
	Control keys function	11
	Setting/permitting items into "USER" menu	11
5.	Setting "LIGHT" menu	12
5.0	Description "LIGHT" menu	12
	"LIGHT" menu input	14
	Setting input - Type "DC"	16
	Setting input - Type "PM"	18
	Setting input - Type "I"	20
	Setting input - Type "LX"	22
	Setting input - Type "DU"	24
	Setting input - Type "T"	26
	Setting Limits	28
	Setting analog output	30
	Selection of programming menu „LIGHT"/„PROFI"	32
	Restoration of manufacture setting	32
	Automatic calibration - input range	33
	Selection of instrument menu language version	34
	Setting new access password	34
	Instrument identification	35
6.	Setting "PROFI" menu	36
6.0	Description of "PROFI" menu	36
6.1	"PROFI" menu - INPUTS	
6.1.1	Resetting internal values	38
6.1.2	Setting measuring type, range, mode, rate	39
6.1.3	Setting the Real Time	41
6.1.4	External input function selection	44
6.1.5	Optional accessory functions of the keys	45
6.2	"PROFI" menu - CHANNEL	
6.2.1	Setting measuring parameters (projection, filters, decimal point, description)	48
6.2.2	Setting mathematic functions	53
6.2.3	Setting integrator parameters	56
6.2.4	Selection of evaluation of min/max. value	60
6.3	"PROFI" menu - OUTPUT	
6.3.1	Setting data logging	62
6.3.2	Setting Limits	64
6.3.3	Setting data output	66
6.3.4	Setting analog output	67
6.3.5	Selection of display projection	69
6.4	"PROFI" menu - SERVICE	
6.4.1	Selection of programming menu „LIGHT"/„PROFI"	70
6.4.2	Restoration manufacture setting	71
6.4.3	Automatic calibration - input range	72
6.4.4	Selection of instrument menu language version	73
6.4.5	Setting new access password	73
6.4.6	Instrument identification	73
7.	Setting items into "USER" menu	74
7.0	Configuration "USER" menu	72
8.	Data protocol	76
9.	Error statements	78
10.	Table of symbols	79
11.	Technical data	80
12.	Instrument dimensions and installation	82
13.	Certificate of guarantee	83
	Declaration of conformity	84

## 2.1 Description

The OM 502 model series are 5 digit panel programmable instruments.

The instrument is based on 8-bit microcontroller with high-rate 24-bit sigma-delta converter, which secures high accuracy, stability and easy operation of the instrument.

### The OM 502 instruments are manufactured in the following types and ranges

<b>DC:</b>	<b>DC Voltmeter/Ammeter</b> ±999,99 mV; ±999,99 mV; ±9,9999 V; ±99,999 V; ±300,00 V ±999,99 µA; ±9,9999 mA; ±99,999 mA; ±999,99 mA; ±5,0000 A
<b>PM:</b>	<b>Process monitor</b> 0...5 mA/0...20 mA/4...20 mA/±2 V/±5 V/±10 V
<b>I:</b>	<b>Integrator</b> 0...5 mA/0...20 mA/4...20 mA/±2 V/±5 V/±10 V
<b>LX:</b>	<b>Linearizerion</b> 0...5 mA/0...20 mA/4...20 mA/±2 V/±5 V/±10 V
<b>DU:</b>	Display unit for <b>linear potentiometers</b> Linear potentiometer (min. 500 Ω)
<b>T:</b>	Weighing indicator 1...4 mV/V; 2...8 mV/V; 4...16 mV/V

### PROGRAMMABLE PROJECTION, FUNCTION

Measuring range:	adjustable (PM, I, LX) or as per order (DC, T)
Setting:	manual, optional display projection may be set for both limit values of the input signal, e.g. input 0...20 mA > 0...8500,0
Projection:	±99999 (-99999...999999)
Integration (I):	with time base 1 s, projection of integrated and current value
Weighing function (T):	manual or automatic calibration, signalization of stabilized equilibrium, zero stabilization, automatic zero monitoring, defined number of sections on the scale
Projection (T):	±99999 (Mode - Standard) selection of size of the section - 0,001/0,002/0,005/0,01/0,02/0,05/0,1/0,2/ 0,5/1/2/5/10/20/50/100 (Mode - WEIGHT)

### LINEARIZATION

Linearization:	by linear interpolation in 50 points (solely via OM Link)
Linearization (LX):	linear interpolation in 256 points and 16 tables

### DIGITAL FILTERS

Floating average:	from 2...30 measurements
Exponen.average:	from 2...100 measurements
Rounding:	setting the projection step for display

### MATHEMATIC FUCTIONS

Min./max. value:	registration of min./max. value reached during measurement
Tare:	designed to reset display upon non-zero input signal
Fixed tare:	fixed preset tare
Peak value:	the display shows only max. or min. value
Mat. operations:	polynome, 1/x, logarithm, exponential, power, root, sin x

**EXTERNAL CONTROL**

Lock:	control keys blocking
Hold:	display/instrument blocking
Tare:	tare activation/resetting tare to zero
Resetting MM:	resetting min/max value
Memory:	data storage into instrument memory

**2.2 Operation**

The instrument is set and controlled by five control keys located on the front panel. All programmable settings of the instrument are performed in three adjusting modes:

<b>LIGHT</b>	<b>Simple programming menu</b> - contains solely items necessary for instrument setting and is protected by optional number code
<b>PROFI</b>	<b>Complete programming menu</b> - contains complete instrument menu and is protected by optional number code
<b>USER</b>	<b>User programming menu</b> - may contain arbitrary items selected from the programming menu (LIGHT/PROFI), which determine the right (see or change) - access without password

All programmable parameters are stored in the EEPROM memory (they hold even after the instrument is switched off).

**OMLINK** Complete instrument operation and setting may be performed via OM Link communication interface, which is a standard equipment of all instruments.

The operation program is freely accessible ([www.orbit.merret.cz](http://www.orbit.merret.cz)) and the only requirement is the purchase of OML cable to connect the instrument to PC. It is manufactured in version RS 232 and USB and is compatible with all ORBIT MERRET instruments. Another option for connection is with the aid of data output RS 232 or RS 485 (without the need of the OML cable).

The program OM LINK in „Basic“ version will enable you to connect one instrument with the option of visualization and archiving in PC. The OM Link „Standard“ version has no limitation of the number of instruments connected.

**2.3 Options**

**Excitation** is suitable for supplying power to sensors and transmitters. It has a galvanic separation.

**Comparators** are assigned to monitor one, two, three or four limit values with relay output. The user may select limits regime: LIMIT/DOSING/FROM-TO. The limits have adjustable hysteresis within the full range of the display as well as selectable delay of the switch-on in the range of 0...99,9 s. Reaching the preset limits is signalled by LED and simultaneously by the switch-on of the relevant relay.

**Data outputs** are for their rate and accuracy suitable for transmission of the measured data for further projection or directly into the control systems. We offer an isolated RS232 and RS485 with the ASCII or DIN MessBus protocol.

**Analog outputs** will find their place in applications where further evaluating or processing of measured data is required in external devices. We offer universal analog output with the option of selection of the type of output - voltage/current. The value of analog output corresponds with the displayed data and its type and range are selectable in Menu.

**Measured data record** is an internal time control of data collection. It is suitable where it is necessary to register measured values. Two modes may be used. FAST is designed for fast storage (40 records/s) of all measured values up to 8 000 records. Second mode is RTC, where data record is governed by Real Time with data storage in a selected time segment and cycle. Up to 250 000 values may be stored in the instrument memory. Data transmission into PC via serial interface RS232/485 and OM Link.

# 3 INSTRUMENT CONNECTION

The instrument supply leads should not be in proximity of the incoming low-potential signals.

Contactors, motors with larger input power should not be in proximity of the instrument.

The leads into the instrument input (measured quantity) should be in sufficient distance from all power leads and appliances. Provided this cannot be secured it is necessary to use shielded leads with connection to ground (bracket E).

The instruments are tested in compliance with standards for use in industrial area, yet we recommend to abide by the above mentioned principles.

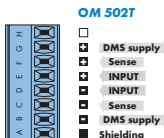
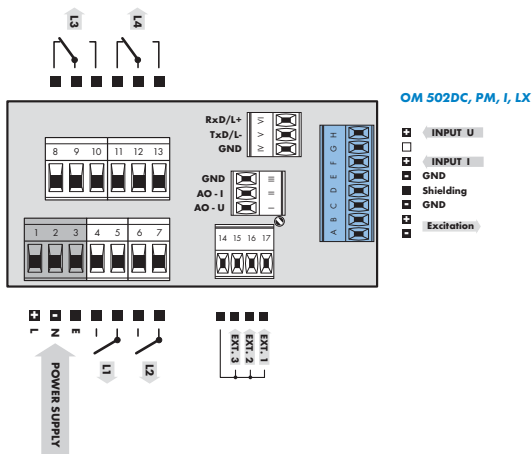

Signal „SENSE“ measures supply voltage on tensionmeter upon 6-wire connection, for 4-wire connection join brackets II+III and VI+VII directly on the instrument. When using the instrument in highly disturbing environment we recommend using 4-wire connection..



Excitation value may be set by trimmer above the terminal block no. 17



Grounding on terminal block 3 has to be connected at all times



Terminal block “Shielding” is designed for connecting shielding of the supply lead (connected only on the side of the instrument).

The “Shielding” and “GND” terminal blocks MUST NOT be connected

## MEASURING RANGES

Type	Input I	Input U
DC	$\pm 999,99 \mu\text{A}$ ; $\pm 9,9999 \text{ mA}$ ; $\pm 99,999 \text{ mA}$ ; $\pm 999,99 \text{ mA}$ ; $\pm 5,0000 \text{ A}$	$\pm 999,99 \text{ mV}$ ; $\pm 999,99 \text{ mV}$ ; $\pm 9,9999 \text{ V}$ ; $\pm 99,999 \text{ V}$ ; $\pm 300,00 \text{ V}$
PM	0...5/20 mA/4...20 mA	$\pm 2/\pm 5/\pm 10 \text{ V}$
I	0...5/20 mA/4...20 mA	$\pm 2/\pm 5/\pm 10 \text{ V}$
LX	0...5/20 mA/4...20 mA	$\pm 2/\pm 5/\pm 10 \text{ V}$
DU	Linear potentiometer (min. 500 $\Omega$ )	
T	1...4 mV/V; 2...8 mV/V; 4...16 mV/V;	

## Selection of jumpers

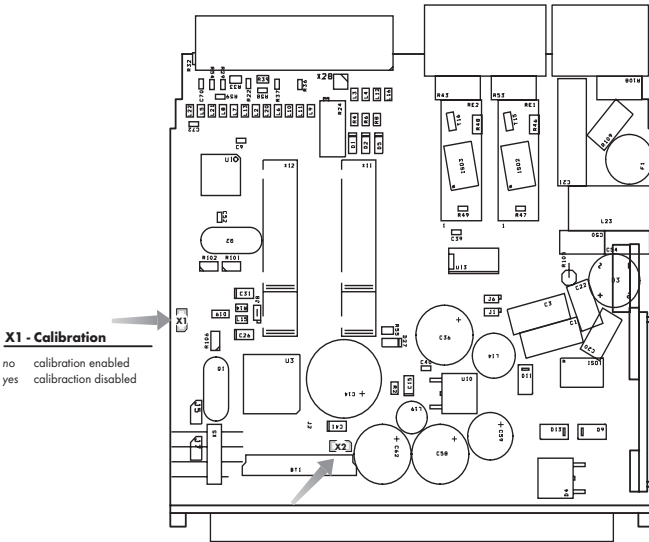

**X1 - Calibration**  
 no calibration enabled  
 yes calibration disabled

**X2 - Battery for RTC**  
 no Battery off  
 yes Battery on

Setting  
PROFI*profi*

- ▶ For expert users
- ▶ Complete instrument menu
- ▶ Access is password protected
- ▶ Possibility to arrange items of the „User“ menu
- ▶ Tree menu structure

Setting  
LIGHT*light*

- ▶ For trained users
- ▶ Only items necessary for instrument setting
- ▶ Access is password protected
- ▶ Possibility to arrange items of the „User“ menu
- ▶ Linear menu structure

Setting  
USER*profi light**user*

- ▶ For user operation
- ▶ Menu items are set by the user (Profi/Light) as per request
- ▶ Access is not password protected
- ▶ Optional menu structure either tree (PROFI) or linear (LIGHT)



## 4.1 Setting

The instrument is set and controlled by five control keys located on the front panel. All programmable settings of the instrument are performed in three adjusting modes:

- LIGHT**      **Simple programming menu**  
 - contains solely items necessary for instrument setting and is protected by optional number code
- PROFI**      **Complete programming menu**  
 - contains complete instrument menu and is protected by optional number code
- USER**      **User programming menu**  
 - may contain arbitrary items selected from the programming menu (LIGHT/PROFI), which determine the right (see or change)  
 - acces without password

All programmable parameters are stored in the EEPROM memory (they hold even after the instrument is switched off).

Complete instrument operation and setting may be performed via OM Link communication interface, which is a standard equipment of all instruments.

The operation program is freely accessible ([www.orbit.merret.cz](http://www.orbit.merret.cz)) and the only requirement is the purchase of OML cable to connect the instrument to PC. It is manufactured in version RS 232 and USB and is compatible with all ORBIT MERRET instruments.

Another option for connection is with the aid of data output RS 232 or RS 485 (without the need of the OML cable).

### Scheme of processing the measured signal

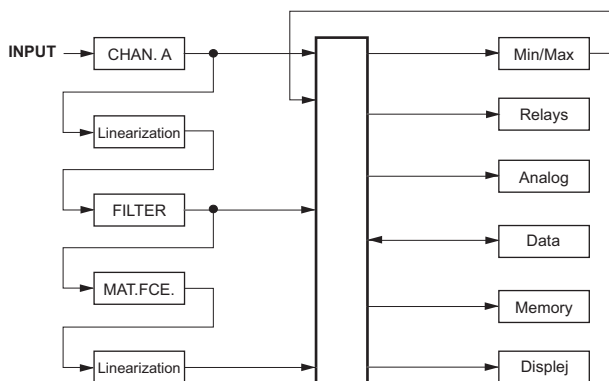

Setting and controlling the instrument is performed by means of 5 control keys located on the front panel. With the aid of these keys it is possible to browse through the operation menu and to select and set required values.

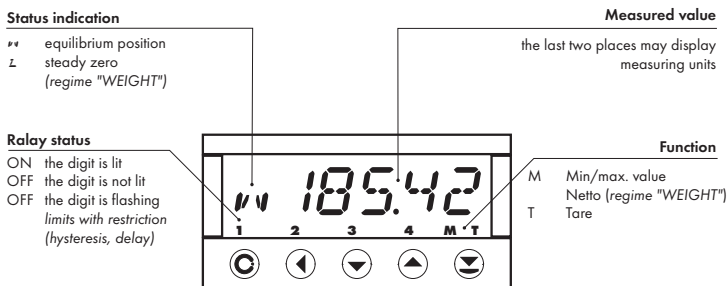

### Symbols used in the instructions

**DC** **PM**  
**DU** **OHM** **RTD** **T/C** Indicates the setting for given type of instrument

**DEF** values preset from manufacture

symbol indicates a flashing light (symbol)

inverted triangle indicates the item that can be placed in USER menu

broken line indicates a dynamic item, i.e. it is displayed only in particular selection/version

after pressing the key the set value will not be stored

after pressing the key the set value will be stored

**30** continues on page 30

### Setting the decimal point and the minus sign

#### DECIMAL POINT

Its selection in the menu, upon modification of the number to be adjusted it is performed by the control key with transition beyond the highest decade, when the decimal point starts flashing. Positioning is performed by .

#### THE MINUS SIGN

Setting the minus sign is performed by the key on higher decade. When editing the item subtraction must be made from the current number (e.g.: 013 > , on class 100 > -87)

## Control keys functions

Key	Measurement	Menu	Setting numbers/selection
	access into USER menu	exit menu	quit editing
	programmable key function	back to previous level	move to higher decade
	programmable key function	move to previous item	move down
	programmable key function	move to next item	move up
	programmable key function	confirm selection	confirm setting/selection
			numeric value is set to zero
	access into LIGHT/PROFI menu		
	direct access into PROFI menu		
		configuration of an item for "USER" menu	
		determine the sequence of items in "USER - LIGHT" menu	

## Setting items into „USER“ menu

- in **LIGHT** or **PROFI** menu
- no items permitted in **USER** menu from manufacture
- on items marked by inverted triangle

Legend is flashing - current setting is displayed



- item will not be displayed in USER menu
- item will be displayed in USER menu with the option of setting
- item will be solely displayed in USER menu

## 5.0 Setting "LIGHT"

## LIGHT

## Simple programming menu

- contains only items necessary for instrument setting and is protected by optional number code



- For capable users
- Only items necessary for instrument setting
- Access is password protected
- Possibility to arrange items of the „User“ menu
- Linear menu structure

## Preset from manufacture

Password	"0"
Menu	LIGHT
USER menu	off
Setting the items	<b>DEF</b>

Access password  
 1428 C+ PASSW. 0

**!**  
 Upon delay exceeding 60 s the programming mode is automatically discontinued and the instrument itself restores the measuring mode

**DC** Setting projection

MIN A 0 MAX A 100 FORM A 0000.00

**PM** Selecting measuring range/Projection setting

MODE 4-20mA MIN A 0 MAX A 100  
 FORM A 0000.00

**I** Selecting measuring range/Projection setting/Setting multiplying and dividing constant

MODE 4-20mA MIN A 0 MAX A 100  
 SCALE 1 DIV.I. 1 FORM I 0000.00

**LX** Selecting measuring range/Projection setting/Table selection

MODE 4-20mA MIN A 0 MAX A 100  
 TAB. # TAB. 0 FORM H. 0000.00

**DU** Projection setting

MIN A 0 MAX A 100 FORM A 0000.00

**T** Selecting measuring mode/Setting projection and tensionmeter sensitivity

MODE STANB. MAX A 100 SENSE 2  
 MAX H. 100 FORM A 0000.00

LIM.L1 20 LIM.L2 40

Option - comparator

LIM.L3 60 LIM.L4 80

Option - Analog output

TYP.AO I 20 MIN.AO 0 MAX.AO 100

Menu type

MENU LIGHT

Return to manufacture calibration

CALIB. YES

Return to manufacture setting

SETTIN. YES

Calibration - only for "DU"

Language selection

LANG. ENGL.

New password

N.PASS. 0

Identification

IDENT. YES

Return to measuring mode

011 502... 1428

1428



PASSW.

0

Entering access password  
for access into the menu

PASSW.

Access into instrument menu

DC
PM
I
LX
DU
T

---

**PAS = 0**

- access into menu is unrestricted, after releasing keys you automaticaly move to first item of the menu

**PAS > 0**

- access into menu is protected ny number code

Set "Password" = 42 Example

0

1

2

02

12

22

10: E

Type „DC“	16
Type "PM"	18
Type "I"	20
Type "LX"	22
Type "DU"	24
Type "T"	26

14 | INSTRUCTIONS FOR USE OM 502



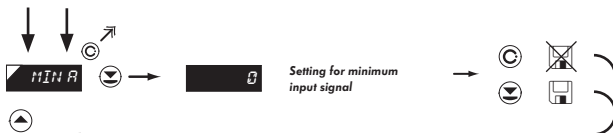

### MIN R Setting display projection for minimum value of input signal

- range of the setting is  $\pm 99999$   
(-99999...99999)

- position of the DP does not affect display projection
- the DP is automatically shifted after the value is confirmed

**DEF** = 0

Projection for 0 mA > MIN A = -25						Example
0	1	2	3	4	5	DP
0.5	-5	-0.5	-1.5	-2.5		MIN R



### MAX R Setting display projection for maximum value of input signal

- range of the setting is  $\pm 99999$   
(-99999...99999)

- position of the DP does not affect display projection
- the DP is automatically shifted after the value is confirmed

**DEF** = 100

Projection for 20 mA > MAX A = 2500						Example
100	100	100	200	300	400	DP
500	0.500	1.500	2.500			MAX R



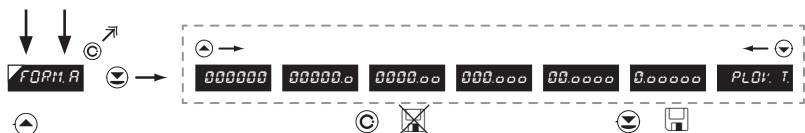

**FORM.A** Setting projection of the decimal point **DEF = 0000.00**

- positioning of the DP is set here in the measuring mode

Projection of DP on display > 00000.0 Example

0000.00 00000.0 MENU \* subsequent item on the menu depends on instrument equipment



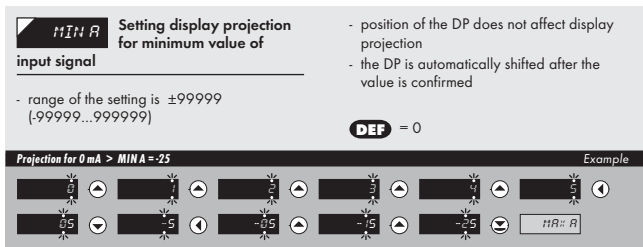
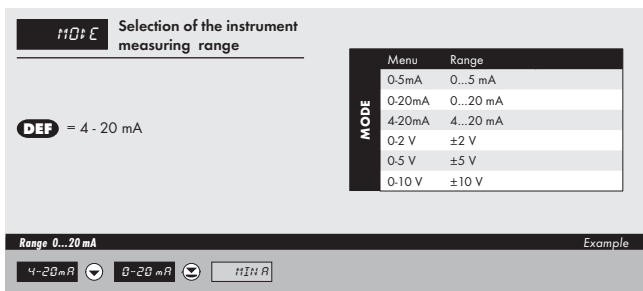



**11A:: R** Setting display projection for maximum value of input signal

- position of the DP does not affect display projection
- the DP is automatically shifted after the value is confirmed

- range of the setting is  $\pm 99999$   
(-99999...99999)

**DEF** = 100

Projection for 20 mA > MAX A = 2500 Example

100	100	100	300	300	400
500	0500	1500	2500	FORM.A	

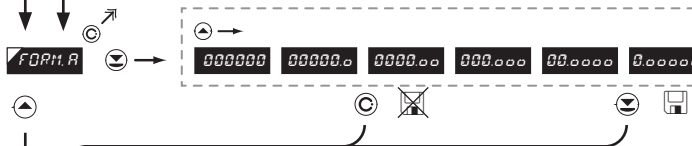

**FORM.A** Setting projection of the decimal point

**DEF** = 0000.00

- positioning of the DP is set here in the measuring mode

Projection of DP on display > 00000.0 Example

0000.00	00000.0	11E+U
---------	---------	-------

\* subsequent item on the menu depends on instrument equipment

**MO: E** → **0-5 mA** **0-20 mA** **4-20 mA** **0-2 V** **0-5 V** **0-10 V** **PM**

**MO: E** Selection of the instrument measuring range

MODE	Menu	Range
	0-5mA	0...5 mA
	0-20mA	0...20 mA
	4-20mA	4...20 mA
	0-2 V	±2 V
	0-5 V	±5 V
	0-10 V	±10 V

**DEF** = 4 - 20 mA

Range 0...20 mA Example

**4-20 mA** **0-20 mA** **MIN A**

**MIN A** Setting for minimum input signal

**MIN A** Setting display projection for minimum value of input signal

- range of the setting is ±99999 (-99999...999999)

- position of the DP does not affect display projection
- the DP is automatically shifted after the value is confirmed

**DEF** = 0

Projection for 0 mA > MIN A = -10 Example

**0** **00** **-10** **MIN A**

**MAX A** Setting for maximum input signal

**MAX A** Setting display projection for maximum value of input signal

- range of the setting is ±99999 (-99999...999999)

- position of the DP does not affect display projection
- the DP is automatically shifted after the value is confirmed

**DEF** = 100

Projection for 20 mA > MAX A = 2500 Example

**100** **100** **100** **200** **300** **400**  
**500** **0500** **1500** **2500** **SCALE**

**SCALE** → Setting the multiplying constant →

**SCALE** Setting the multiplying constant constant it is easy to set the displayed value for required time period

- range of the setting is 1...100 000
- by using the multiplying and dividing

**DEF** = 1

**Multiplying constant > NASOB. = 1** Example

**÷I'IP.** → Selecting the dividing constant →

**÷I'IP.** Selecting the dividing constant - by using the multiplying and dividing constant it is easy to set the displayed value for required time period

- range 1/10/60/100/1 000/3 600

**DEF** = 1

**Dividing constant 3600 > DIVID. = 3600** Example

**FORM.I** → Setting projection of the decimal point →

**FORM.I** Setting projection of the decimal point **DEF** = 0000.00

- positioning of the DP is set here in the measuring mode

**Projection of DP on display > 00000.0** Example

\* subsequent item on the menu depends on instrument equipment



**MOD: E** Selection of the instrument measuring range

**DEF** = 4 - 20 mA

MOD	Menu	Range
	0-5mA	0...5 mA
	0-20mA	0...20 mA
	4-20mA	4...20 mA
	0-2 V	±2 V
	0-5 V	±5 V
	0-10 V	±10 V

Range 0...20 mA Example

4-20 mA 0-20 mA MIN R



**MIN R** Setting display projection for minimum value of input signal

- range of the setting is  $\pm 99999$   
(-99999...999999)

**DEF** = 0

Projection for 0 mA > MIN A = -25 Example

6	1	0.5	0.1	0.05	0.01	0.001
0.5	0.1	-0.5	-1	-0.5	-1	-0.5

MIN R

- position of the DP does not affect display projection
- the DP is automatically shifted after the value is confirmed

**MAX: A** → **100** *Setting for maximum input signal*

**TAB: #** → **TAB 0** **TAB 1** ... **TAB 14** **TAB 15**

**FORM: M** → **000000** **00000.0** **0000.00** **000.000** **00.0000** **0.00000** **PLD: T**

**MAX: A** **Setting display projection for maximum value of input signal**

- range of the setting is  $\pm 99999$  (-99999...99999)
- position of the DP does not affect display projection
- the DP is automatically shifted after the value is confirmed

**DEF = 100**

**Projection for 20 mA > Max = 2500** *Example*

100	100	100	200	300	400
500	0500	1500	2500	TAB: #	

**TAB: #** **Selection of the linearization table**

**DEF = TAB. 0**

**Selection of the linearization table - Tabulka 1 > TAB. 1** *Example*

TAB. 0	TAB. 1	FORM: M
--------	--------	---------

**FORM: M** **Setting projection of the decimal point**

- positioning of the DP is set here in the measuring mode

**DEF = 0000.00**

**Projection of DP on display > 00000.0** *Example*

0000.00	00000.0	MENU
---------	---------	------

\* subsequent item on the menu depends on instrument equipment



**MIN R** Setting display projection for minimum value of input signal

- position of the DP does not affect display projection
- the DP is automatically shifted after the value is confirmed

- range of the setting is  $\pm 99999$   
(-99999...99999)

**DEF** = 0

Projection for the beginning > MIN A = 0 Example



**MAX R** Setting display projection for maximum value of input signal

- position of the DP does not affect display projection
- the DP is automatically shifted after the value is confirmed

- range of the setting is  $\pm 99999$   
(-99999...99999)

**DEF** = 100

Projection for the end > MAX A = 5000 Example



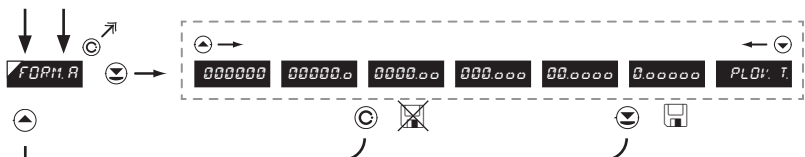

**FORM.A**
Setting projection of the decimal point
**DEF** = 0000.00

- positioning of the DP is set here in the measuring mode

---

**Projection of DP on display > 0000.00**
Example

0000.00
▼
11E+11
\* subsequent item on the menu depends on instrument equipment

**28**

Calibration of the beginning and the end of range of linear potentiometer is on page 33





**MODE** Selection of measuring mode

**DEF** = STAND.

MODE	Menu	Measuring mode
	STAND.	Standard
	WEIGHT	Weighing function

Mode "WEIGHT" Example

STAND. **WEIGHT** **MA: A**



**MA: A** Setting the tensionmeter range

- range of the setting is -99999...999999
- position of the DP does not affect display projection
- DP is automatically shifted after the value is confirmed

**DEF** = 100

Weighing range is 200 kg > MAX A = 200 Example

100 100 100 200 SENSE

**!**

Manual calibration:

MAX Sensor range

SENSE Sensor sensitiveness

Automatic calibration  
(after calibration in menu "SERVIC./CALIB."):

MIN The load at which minimum calibration was performed

MAX The load at which maximum calibration was performed

- for maximum calibration we recommend the value of reference load to be in the upper third of the measuring range

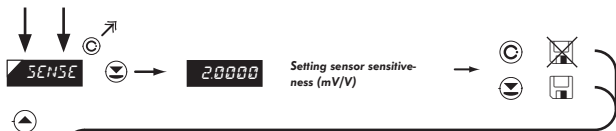

**SENSE** Setting display projection for maximum input signal value

- DP is automatically shifted after the value is confirmed

**DEF** = 2.00

- range of the setting: 0,2...4,0 (1...4 mV/V)
- range of the setting: 0,4...8,0 (2...8 mV/V)
- range of the setting: 0,8...16,0 (1...4 mV/V)

Sensitiveness 2,0018 > SENSE = 2,0018 Example

0,2	0,4	0,8	1,6	3,2	6,4	12,8
0,2	0,4	0,8	1,6	3,2	6,4	12,8
0,2	0,4	0,8	1,6	3,2	6,4	12,8

FORM: R

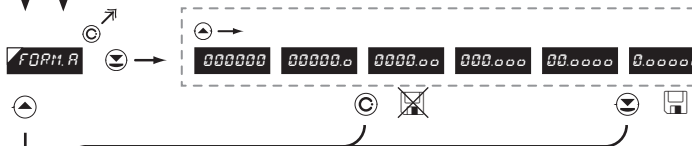

**FORM: R** Setting projection of the decimal point

**DEF** = 0000.00

- positioning of the DP is set here in the measuring mode

Projection of DP on display > 00000.0 Example

000000	00000.0	0000.00	000.000	00.0000	0.00000	PL0: T
--------	---------	---------	---------	---------	---------	--------

\* subsequent item on the menu depends on instrument equipment



**LIM.L.1** Setting boundary for limit 1

- contingent modification of hysteresis or delay may be performed in "PROFI" menu
- range of the setting is -99999...999999
- default "Hysteresis"=0 "Delay"=0

**DEF** = 20

Setting limit 1 > LIM.L.1 = 32 Example

The example menu shows a grid of values: 20, 21, 22, 23, 32. Each value has navigation arrows above and below it. A 'MENU' button is on the right.

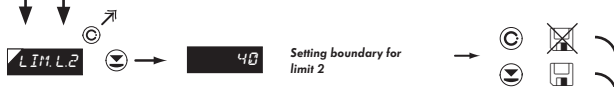

**LIM.L.2** Setting boundary for limit 2

- contingent modification of hysteresis or delay may be performed in "PROFI" menu
- range of the setting is -99999...999999
- default "Hysteresis"=0 "Delay"=0

**DEF** = 40

Setting limit 2 > LIM.L.2 = 53.1 Example

The example menu shows a grid of values: 40, 41, 53.1, 31, 0053.1. Each value has navigation arrows above and below it. A 'MENU' button is on the right.

\* subsequent item on the menu depends on instrument equipment

**!** Items for "Limits" and "Analog output" are accessible only if incorporated in the instrument.



**LIM.L3** Setting boundary for limit 3

- range of the setting is -99999...999999
- default "Hysteresis"=0 "Delay"=0

**DEF** = 60

Setting limit 3 > LIM.L3 = 85 Example

60	61	62	63	64	65
65	75	85	MENU		

\* subsequent item on the menu depends on instrument equipment



**LIM.L4** Setting boundary for limit 4

- range of the setting is -99999...999999
- default "Hysteresis"=0 "Delay"=0

**DEF** = 80

Setting limit 4 > LIM.L4 = 103 Example

80	81	82	83	84	85
83	003	103	MENU		

\* subsequent item on the menu depends on instrument equipment

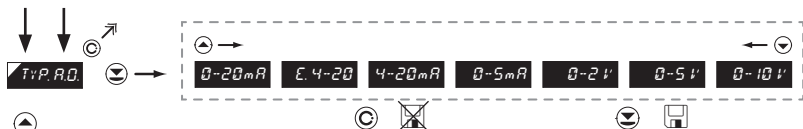

**TYP.A.O.** Setting the type of analog output

Menu	Range	Description
0-20mA	0...20 mA	
E. 4-20mA	4...20 mA	with indication of error statement (<3,6 mA)
4-20mA	4...20 mA	
0-5mA	0...5 mA	
0-2 V	0...2 V	
0-5 V	0...5 V	
0-10 V	0...10 V	

**DEF** = 4...20 mA

Type of analog output - 0...10 V > TYP.AV. = U 10 Example

4-20mA   0-5mA   0-2V   0-5V   0-10V   MIN.A.O.

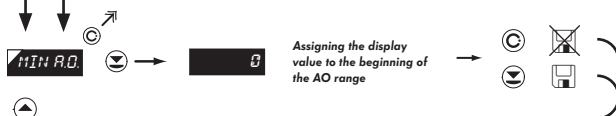

**MIN.A.O.** Assigning the display value to the beginning of the AO range **DEF** = 0

- range of the setting is -99999...999999

Display value for the beginning of the AO range > MIN.AV. = 0 Example

0 MIN.A.O.

**!**

Items for "Limits" and "Analog output" are accessible only if incorporated in the instrument.

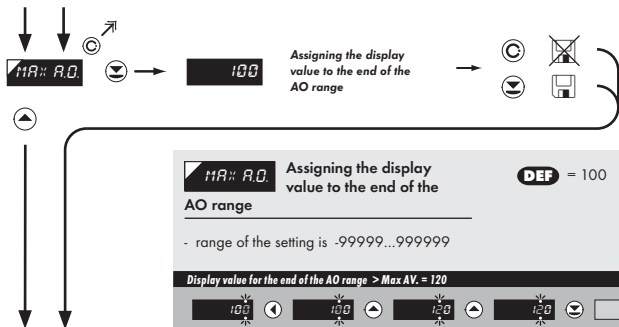

Displayed only with options > **Analog output**

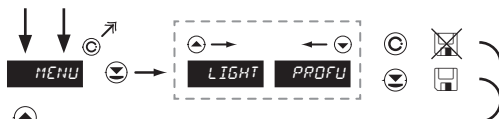

### MENU Setting the menu type LIGHT/PROFI

**LIGHT** > menu LIGHT, a simple menu,  
which contains only the most essential items  
necessary for instrument setting  
> linear tree structure

**PROFI** > menu PROFU, a complete menu for  
complete instrument setting  
> tree menu structure

**DEF** = LIGHT

#### Menu LIGHT > MENU = LIGHT

Example

LIGHT  CALIB

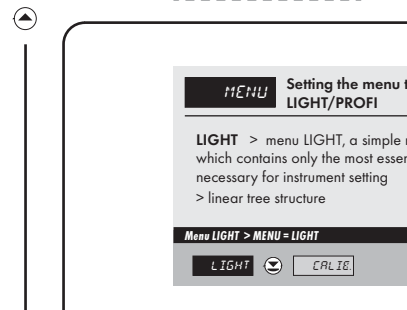

### CALIB. Restoration of manufacture calibration

- in the event of error calibration it is feasible  
to restore manufacture setting.

- prior to execution of any modifications you  
will be asked to confirm your selection.  
(YES)

#### Restoration of manufacture calibration > CALIB.

Example

CALIB.  YES  SETTING

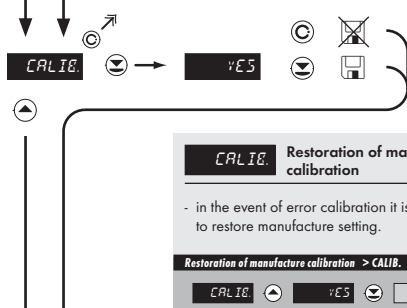

### SETTING. Restoration of manufacture instrument setting

- in the event of error setting it is feasible to  
restore manufacture setting

- prior to execution of any modifications you  
will be asked to confirm your selection.  
(YES)  
- loading manufacture calibration and  
primary setting of items on the menu (DEF)

#### Restoration of manufacture setting > RESTOR.

Example

SETTING  YES  LANG \* subsequent item on the menu depends on instrument type, for "DU" > "K\_MIN"

Type „DC“		34
Type "PM"		34
Type "I"		34
Type "LX"		34
Type "DU"		33
Type "T"		34



Typ "DU"

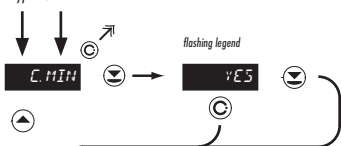

**!**  
Automatická kalibrace je nutná pouze pro typ "DU", pro ostatní verze dle požadavků uživatele

**C.MIN** Calibration of input range - the potentiometer traveller in initial position Only for type "DU"

---

- prior confirming the flashing "YES" sign the potentiometer traveller has to be in given idle position

**Calibration of the beginning of the range > C. MIN** Example

**YES**

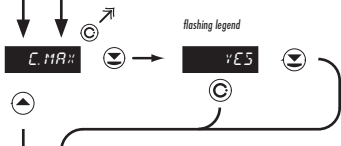

**C.MAX** Calibration of input range - the potentiometer traveller in end position Only for type "DU"

---

- prior confirming the flashing "YES" sign the potentiometer traveller has to be in given idle position

**Calibration of the end of the range > C. MAX** Example

**YES**



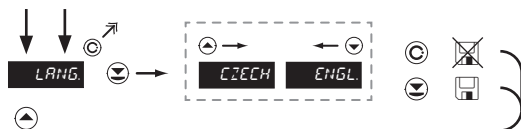

**LANG.** Selection of language in instrument menu

- selection of language version of the instrument menu

**DEF** = ENGL.

Language selection - ENGLISH > LANG. = ENGL. Example

CZECH ◀ ENGL. ▶ N. PASS

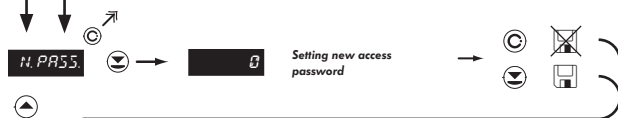

**N. PASS.** Setting new access password

- access password for menu LIGHT/PROFI
- range of the number code 0...9999

upon setting the password to "000" the access to menu LIGHT/PROFI is free without prompt to enter it

in the event of loss universal password "8177" may be used

**DEF** = 0

New password - 341 > N.PASSW. = 341 Example

0 1 2 3 4 5 6 7 8 9

4 1 1 4 1 2 4 1 3 4 1

ENTER

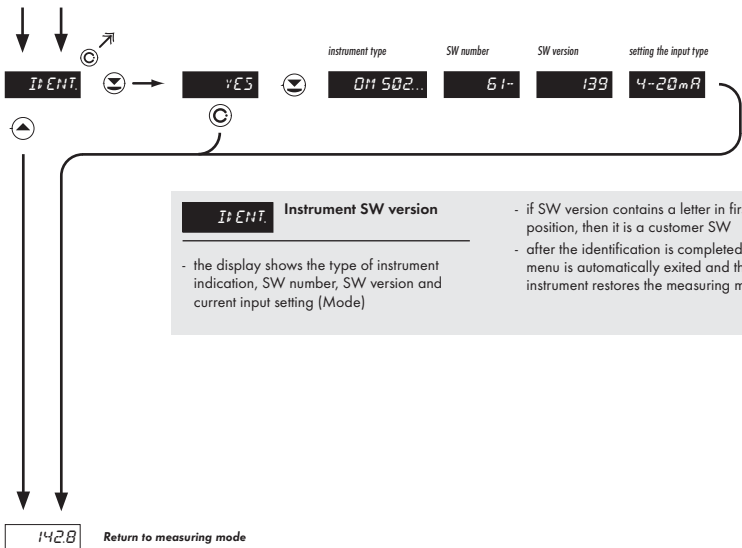

## 6.0

## Setting "PROFI"

## PROFI

## Complete programming menu

- contains complete instrument menu and is protected by optional number code
- designed for expert users
- preset from manufacture is menu **LIGHT**

 SETTING  
PROFI



- For expert users
- Complete instrument menu
- Access is password protected
- Possibility to arrange items of the „User“ menu
- Tree menu structure

## Switchng over to "PROFI" menu



- direct access to **PROFI** menu, irrespective of the menu type setting (SERVICE/MENU)
- after quitting **PROFI** menu the instrument automatically switches to **LIGHT** menu
- access is password protected (if it was not set under item N. PASS. =0)



- access into „menu“ (**LIGHT/PROFI**) according to the setting in item (SERVICE/MENU)
- access is password protected (if it was not set under item N. PASS. =0)



## 6.1 Setting "PROFI" - INPUT

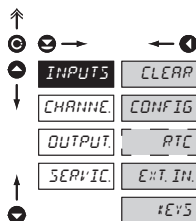

The primary instrument parameters are set in this menu

- CLEAR** Resetting internal values
- CONFIG** Selection of measuring range and parameters
- RTC** Setting date and time for option with RTC
- EXT. IN** Setting external inputs functions
- \*EVS** Assigning further functions to keys on the instrument

## 6.1.1 Resetting internal values

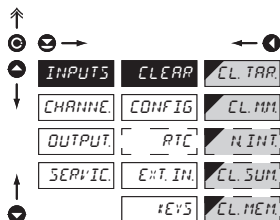

- CLEAR** Resetting internal values to zero
- CL. TAR.** Tare resetting
- CL. MIN.** Resetting min/max value
  - resetting memory for storing the minimum and maximum values reached during measurement
- CL. INT.** Resetting integrated value
  - only for instrument OM 5021
- CL. SUM.** Resetting the sum
  - summation serves for cumulative totals of values (e.g. shift operation), when after resetting the integrator ("CL. INT") the display value is added to the total ("SUM")
  - only for instrument OM 5021
- CL. MEM.** Clear instrument memory
  - clear memory with data measured in the "FAST" or "RTC" mode
  - not in standard instrument equipment

#### 6.1.2a Selection of measuring rate

The screenshot shows the main menu with the following options:

- INPUTS** (highlighted)
- CLEAR**
- MEASURING RATE** (highlighted)
- 100.0**
- CHANNEL**
- CONFIG** (highlighted)
- MODE**
- 66.7**
- OUTPUT**
- PTC**
- TRACE**
- 50.0**
- SERVICE**
- EXT. IN.**
- REL. ZERO**
- 25.0**
- 1E+5**
- 12.5**
- 10.0**
- 8.0**
- 4.0** (DEF)
- 2.0**
- 1.0** (DEF VAHA)
- 0.5**
- 0.3**
- 0.1**

The detailed view shows the 'MEASURING RATE' selection screen with the following options:

- MEASURING RATE** (highlighted)
- 100.0** 100,0 measurements/s
- 66.7** 66,7 measurements/s
- 50.0** 50,0 measurements/s
- 25.0** 25,0 measurements/s
- 12.5** 12,5 measurements/s
- 10.0** 10,0 measurements/s
- 8.0** 8,0 measurements/s
- 4.0** 4,0 measurements/s
- DEF**
- 2.0** 2,0 measurements/s
- 1.0** 1,0 measurements/s
- DEF** for OM 502T > mode WEIGHT
- 0.5** 0,5 measurements/s
- 0.3** 0,3 measurements/s
- 0.1** 0,1 measurements/s

## 6.1.2b Selection of measuring range/mode

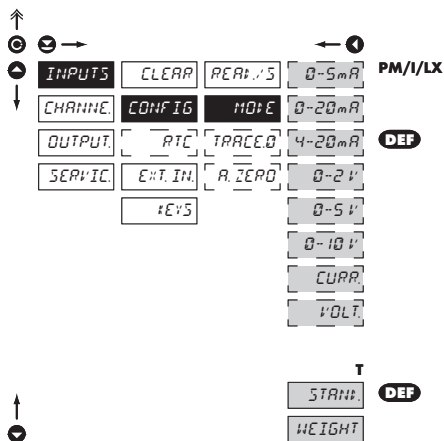

**MODE** Selection of instrument measuring range/mode

Menu	Range
0-5mA	0...5 mA
0-20mA	0...20 mA
4-20mA	4...20 mA
0-2 V	±2 V
0-5 V	±5 V
0-10 V	±10 V
CURR.	Current range after automatic calibration
VOLT.	Voltage range after automatic calibration

Menu	Measuring mode
STANB.	Standard mode
WEIGHT	Weighing mode

## 6.1.2c Selection of automatic zero monitoring

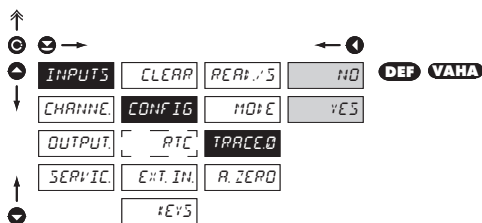
T



**TRACE0** Selection of automatic zero monitoring

NO	Function is off
YES	Function is on

- in 4% of the measuring range zero automatically faces the condition that correction must not be larger than 0,5 section/sec
- setting is possible only for mode "WEIGHT"

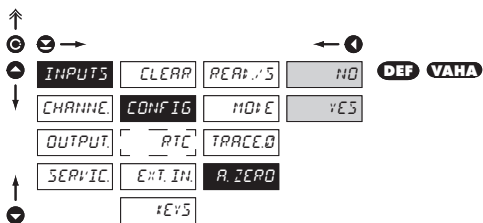

#### 6.1.2d Selection of automatic weight resetting

**T**

#### A.ZERO Selection of automatic weight resetting

**NO** Function is off

**YES** Function is one

- if stabilized negative value is displayed for a period > 5 s (at active Tare function) the tare is automatically reset
- selection is possible only for mode "WEIGHT"

#### 6.1.3 Setting the real time clock

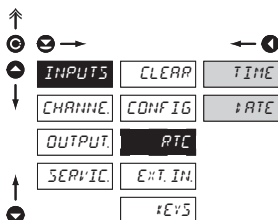

#### RTC Setting the real time clock (RTC)

**TIME** Time setting

- format 23.59.59

**DATE** Date setting

- format DD.MM.YY

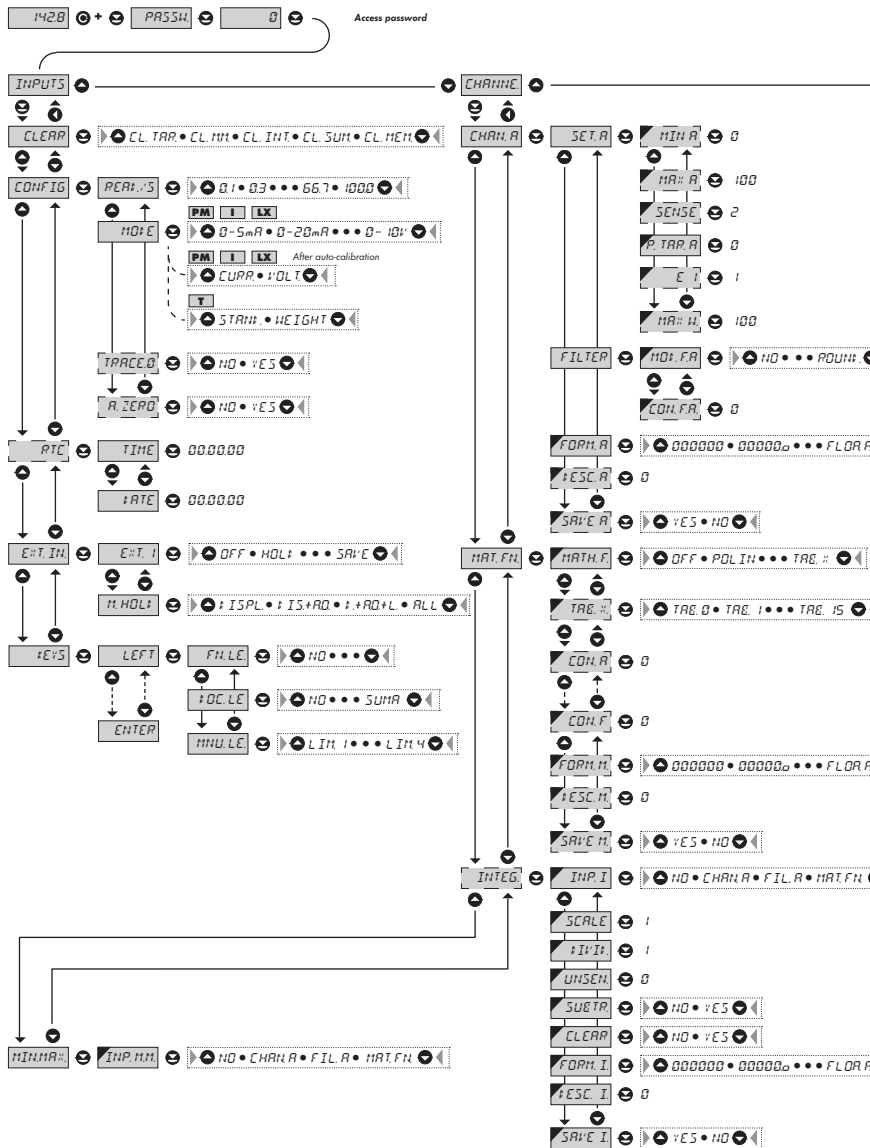

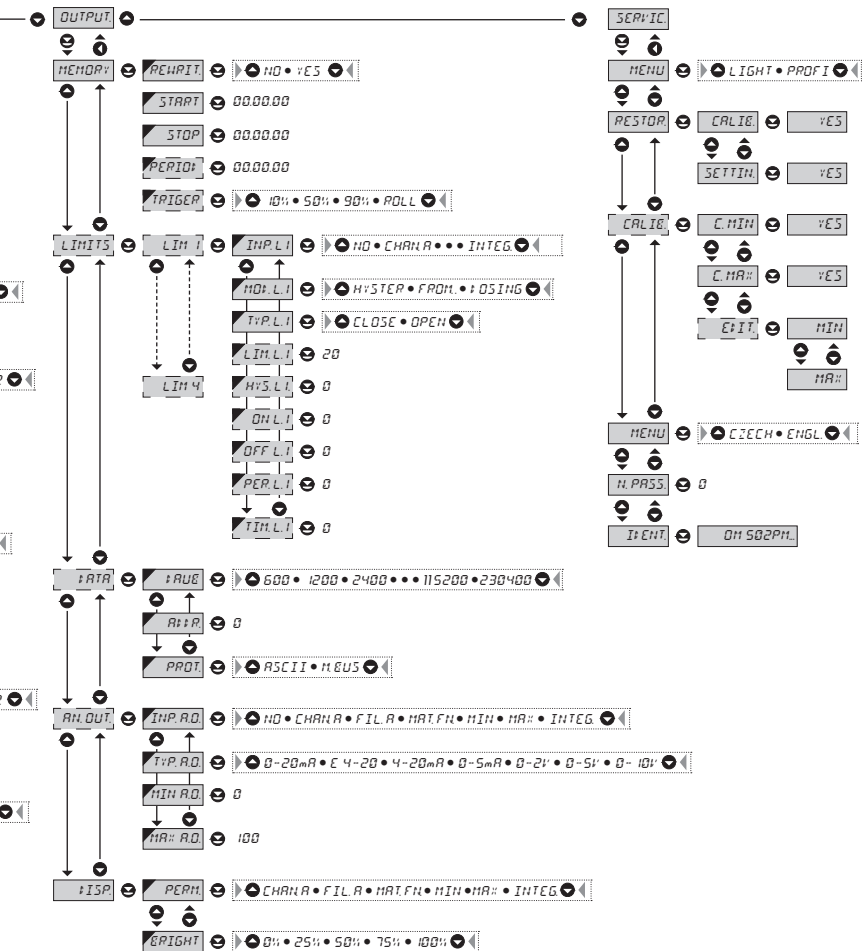

**!**  
 Upon delay exceeding 60 s the programming mode is automatically discontinued and the instrument itself restores the measuring mode

## 6.1.4a External input function selection

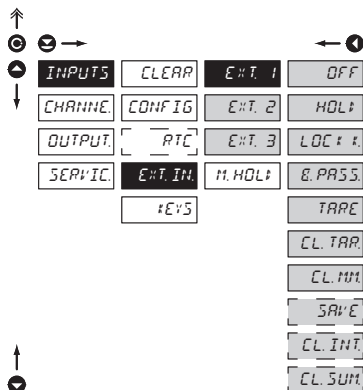

### EXT. IN. External input function selection

- OFF** Input is off
- HOLD** Activation of HOLD
- LOCK K.** Locking keys on the instrument
- E. PASS.** Activation of locking access into programming menu LIGHT/PROFI
- TARE** Tare activation
- CL. TAR.** Tare resetting
- CL. MIN.** Resetting min/max value
- SAVE** Activation of the measured data record into instrument memory (not in standard equipment)
- CL. INT.** Resetting integrated value
  - only for instrument OM 5021
- CL. SUM.** Resetting the sum
  - only for instrument OM 5021

\*

Setting procedure is identical for Ext. 2 and Ext. 3

#### 6.1.4b Selection of function "HOLD"

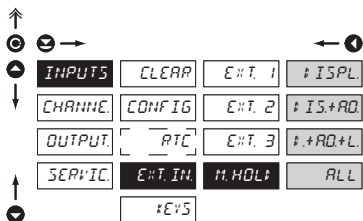

#### M.HOLD Selection of function "HOLD"

↑ ISPL.	"HOLD" locks only the value displayed
↑ IS+AD.	"HOLD" locks the value displayed and on AO
↑+AD+L.	"HOLD" locks the value displayed, on AO and limit evaluation
ALL	"HOLD" locks the entire instrument

#### 6.1.5a Optional accessory functions of the keys

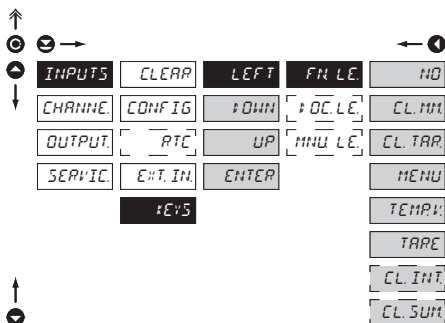

#### FN. LE. Assigning further functions to instrument keys

- „FN. LE.“ > executive functions
- „TMP. LE.“ > temporary projection of selected values
- „MNU. LE.“ > direct access into menu on selected item

NO	Key has no further function
CL. MIN.	Resetting min/max value
CL. TARE	Tare resetting
MENU	Direct access into menu on selected item
TEMP. V.	Temporary projection of selected values
TARE	Tare function activation
CL. INT.	Resetting integrated value
CL. SUM.	Resetting the sum

**!**  
Setting is identical for LEFT, DOWN, UP and ENTER

## 6.1.5b Optional accessory functions of the keys - Temporary projection

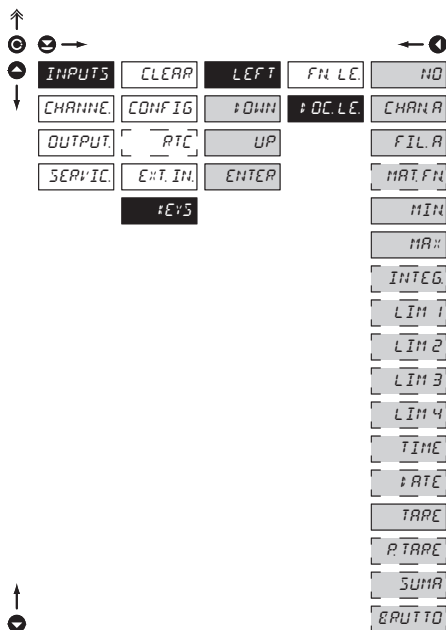

Preset values of the control keys **DEF**:

LEFT	Show Tare
UP	Show Max. value
DOWN	Show Min. value
ENTER	w/o function



Setting is identical for LEFT, DOWN, UP and ENTER

### THP. LE. Temporary projection of selected item

- "Temporary" projection of selected value is displayed for the time of keystroke
- "Temporary" projection may be switched to permanent by pressing **⊕** + "Selected key", this holds until the stroke of any key

NO	Temporary projection is off
CHAN.A	Temporary projection of "Channel A" value
FIL.A	Temporary projection of "Channel A" value after processing digital filters
MAT. FN.	Temporary projection of "Mathematic functions" value
MIN	Temporary projection of "Min. value"
MAX	Temporary projection of "Max. value"
INTEG.	Temporary projection of "Integrated value"
LIM 1	Temporary projection of "Limit 1" value
LIM 2	Temporary projection of "Limit 2" value
LIM 3	Temporary projection of "Limit 3" value
LIM 4	Temporary projection of "Limit 4" value
TIME	Temporary projection of "TIME" value
DATE	Temporary projection of "DATE" value
TARE	Temporary projection of "TARE" value
P. TARE	Temporary projection of "P. TARE" value
SUMA	Temporary projection of "SUM"
ERUTTO	Temporary projection of the sum of the values of "CHAN. A + TARE + P. TARE"

#### 6.1.5c Optional accessory functions of the keys - Direct access to item

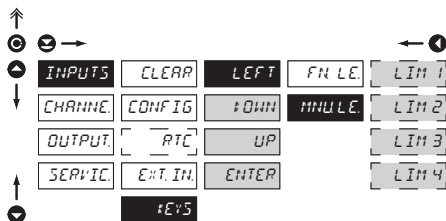

**MINU LE** Assigning access to selected menu item

- LIM 1** Direct access to item "LIM 1"
- LIM 2** Direct access to item "LIM 2"
- LIM 3** Direct access to item "LIM 3"
- LIM 4** Direct access to item "LIM 4"



Setting is identical for LEFT, DOWN, UP and ENTER

## 6.2 Setting "PROFI" - CHANNELS

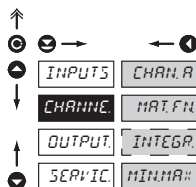

The primary instrument parameters are set in this menu

- CHAN.A** Setting parameters of measuring "Channel"
- MAT.FN.** Setting parameters of mathematic functions
- INTEGR.** Setting parameters for integrator (OM 502I)
- MIN.MA.:** Selection of access and evaluation of Min/max value

### 6.2.1a Projection on display - manual calibration

**DC PM DU I LX**

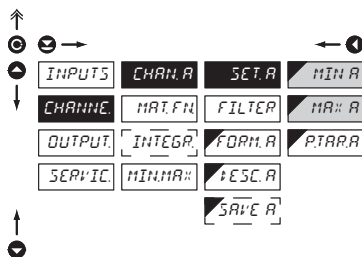

- SET.A** Setting display projection

---

- MIN.A** Setting display projection for minimum value of input signal
  - range of the setting is -99999...999999
  - menu is dynamic, after using automatic calibration this item is no more displayed
  - **DEF** = 0

---

- MA.A** Setting display projection for maximum value of input signal
  - range of the setting is -99999...999999
  - **DEF** = 100



### 6.2.1b Projection on display - manual calibration

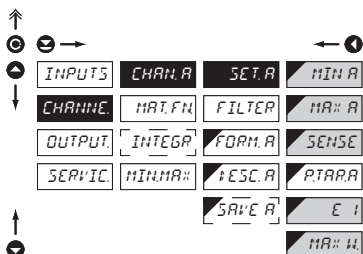

**!**

**Manual calibration:**  
 MAX Sensor range  
 SENSE Sensor sensitiveness

**Automatic calibration**  
 (after calibration in menu "SERVICE/CALIB."):  
 MIN size of load, with which minimum calibration was performed  
 MAX size of load, with which maximum calibration was performed

- upon maximum calibration we recommend the reference load value in the upper third of the measuring range

#### SET.A Setting display projection

**MIN.A** Setting display projection for minimum value of input signal

- range of the setting is -99999...999999
- menu is dynamic, in manual calibration this item is not displayed
- **DEF** = 0

**MA.A** Setting display projection for maximum value of input signal

- range of the setting is -99999...999999
- **DEF** = 100

**SENSE** Setting the tensionmeter sensitiveness (mV/V)

- range 1...4/2...8/4...16 mV/V
- fixed resolution in 4 decimal points
- menu is dynamic, the item is displayed only in automatic calibration

**E 1** Setting the size of sections for projection

- range 0.001-0.002-0.005-0.01...100

**MA.A** Setting the upper weighing limit

- range of the setting: -99999...999999

### 6.2.1c Setting fixed tare

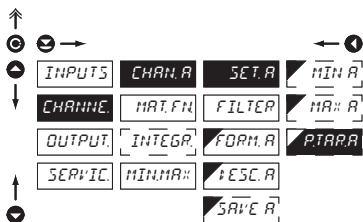

#### P.TAR.A Setting "Fixed tare" value

- setting is designed for the event when it is necessary to firmly shift the beginning of the range by known size
- when setting (P.TAR.A > 0) display shows "T" symbol
- range of the setting is 0...999999
- **DEF** = 0

## 6.2.1d Digital filters

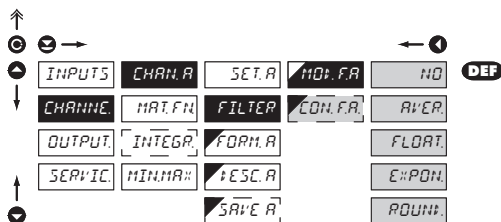
**HOLD.FA.** Selection of digital filters

- at times it is useful for better user projection of data on display to modify it mathematically and properly, wherefore the following filters may be used:

**NO** Filters are off

**AVER** Measured data average

- arithmetic average from given number („CON. F.A.”) of measured values
- range 2...100

**FLOAT** Selection of floating filter

- floating arithmetic average from given number („CON. F.A.”) of measured data and updates with each measured value
- range 2...30

**EXPON** Selection of exponential filter

- integration filter of first prvnho grade with time constant („CON. F.A.”) measurement
- range 2...100

**ROUND** Measured value rounding

- is entered by any number, which determines the projection step (e.g: “CON. F.A.”=2,5 > display 0, 2,5, 5,...)

**CON.FA.** Setting constants

- this menu item is always displayed after selection of particular type of filter

**DEF** = 2

#### 6.2.1e Projection format - positioning of decimal point

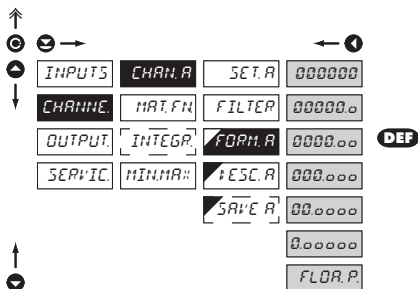

#### FORM.A Selection of decimal point

- the instrument allows for classic projection of a number with positioning of the DP as well as projection with floating DP, allowing to display a number in its most exact form „FLOAT.P.“

000000 Setting DP - XXXXXX.

00000.0 Setting DP - XXXXX.x

0000.00 Setting DP - XXXX.xx

000.000 Setting DP - XXX.xxx

00.0000 Setting DP - XX.xxxx

0.00000 Setting DP - X.xxxxx

FLOR.P. Floating DP

#### 6.2.1f Projection of description - the measuring units

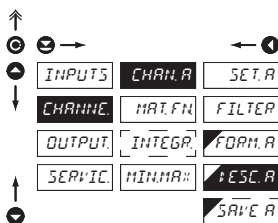

#### +ESC.A Setting projection of descrpt. for "Channel A"

- projection of measured data may be extended (at the expense of the number of displayed places) by two characters for description
- description is set by shifted ASCII code, when two first places show the set description and two last characters their code in period 0...95
- description is cancelled by code 00



Table of signs on page 79

## 6.2.1g Selection of storing data into instrument memory

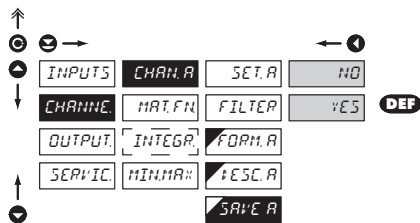
**SAVE A** Selection of storing data into instrument memory

- by selection in this item you allow to register values into instrument memory
- another setting in item "OUTPUT. > MEMORY" (not in standard experiment)

**YES** Measured data are stored in the memory

**NO** Measured data are not stored

#### 6.2.2a Mathematic functions

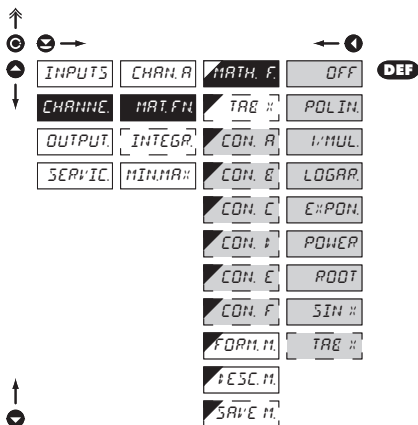

#### MATH.F. Selection of mathematic functions

**OFF** Mathematic functions are off

**POLIN** Polynome

$$Ax^5 + Bx^4 + Cx^3 + Dx^2 + Ex + F$$

**1/MUL**  $1/x$

$$\frac{A}{x^3} + \frac{B}{x^4} + \frac{C}{x^3} + \frac{D}{x^2} + \frac{E}{x} + F$$

**LOGAR** Logarithm

$$A \times \ln\left(\frac{Bx + C}{Dx + E}\right) + F$$

**E#PON** Exponential

$$A \times e^{\left(\frac{Bx+C}{Dx+E}\right)} + F$$

**POWER** Power

$$A \times (Bx + C)^{(Dx+E)} + F$$

**ROOT** Root

$$A \times \sqrt{\frac{Bx + C}{Dx + E}} + F$$

**SIN #** Sin x

$$A \sin^5 x + B \sin^4 x + C \sin^3 x + D \sin^2 x + E \sin x + F$$

**TAB #** Turning on the linearization table

- this menu is available only in OM 502LX

**CON. #** Setting constants for calculation of mat. functions

- this menu is displayed only after selection of given mathematic function

## 6.2.2b Mathematic functions - selection of linearization table

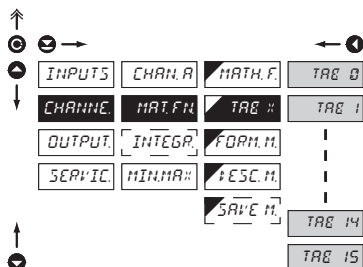
**TABE #** Selection of linearization table

- this item is available only in type OM 502LX

TABE 0 Table number 0

TABE 1 Table number 1

-----  
TABE 14 Table number 14

TABE 15 Table number 15

## 6.2.2c Mathematic functions - decimal point

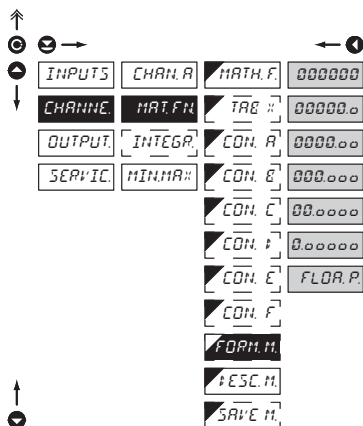
**FORM. H.** Selection of decimal point

- the instrument allows for classic projection of a number with positioning of the DP as well as projection with floating DP, allowing to display a number in its most exact form „FLOA.P.“

000000 Setting DP - XXXXXX.

00000.0 Setting DP - XXXXX.x

0000.00 Setting DP - XXXX.xx

000.000 Setting DP - XXX.xxx

00.0000 Setting DP - XX.xxxx

0.00000 Setting DP - X.xxxxx

FLOA.P. Floating DP

**DEF**

#### 6.2.2d Mathematic functions - measuring units

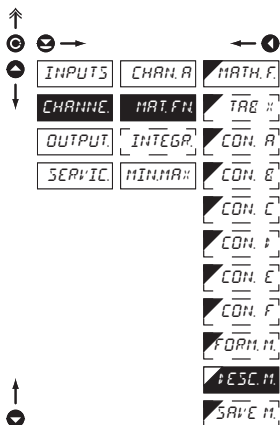

#### F.E.S.C.H. Setting projection of description for "MAT.FN"

- projection of measured data may be extended (at the expense of the number of displayed places) by two characters for description
- description is set by shifted ASCII code, when two first places show the set description and two last characters their code in period 0...95
- description is cancelled by code 00
- **DEF** = no description



Table of signs on page 79

#### 6.2.2e Mathematic functions - selection of storing data into instrument memory

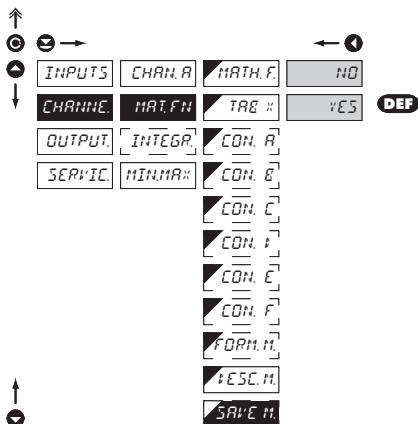

#### SAVE.H. Selection of storing data into instrument memory

- by selection in this item you allow to register values into instrument memory
- another setting in item "OUTPUT. > MEMORY" (not in standard experiment)

YES

Measured data are stored in the memory

NO

Measured data are not stored

## 6.2.3a Selection of input quantity for calculation

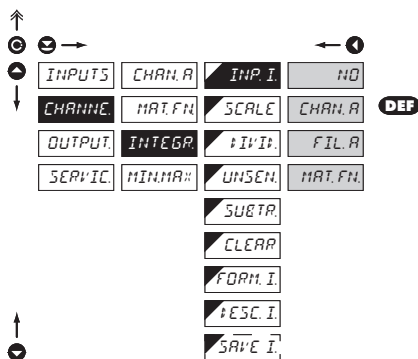
**INTEGR.** Selection of input quantity for calculation

- selecting value from which the integrated value will be calculated

NO	Evaluation of min/max value is off
CHAN. A	From "Channel A"
FIL. A	From "Channel A" after modification by dig.filter
MAT. FN.	From "Mathematic functions"



Primary setting of "Integrator" range is under "CHANNELS/SETTING A/MAX A, where maximum projection is set at time base 1 s

## 6.2.3b Setting calibration constants

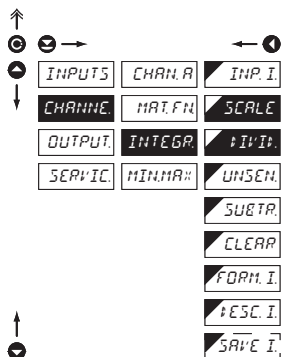
**SCALE** Setting the multiplying constant

- through multiplying constant we may further mathematically adjust the data display projection
- range of the setting is 1...100 000
- **DEF** = 1

**1/IV.F.** Setting the dividing constant

- through dividing constant we may further mathematically adjust the data display projection
- range 1/10/60/100/1000/3600
- **DEF** = 1



#### 6.2.3c Setting the "zero" band of insensitiveness

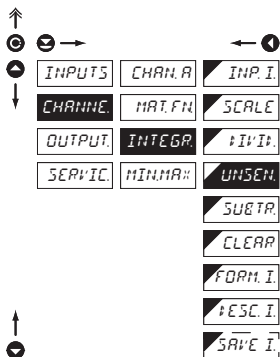

#### **UNSEN.** Setting the band of insensitiveness

- by setting this item it is possible to extend "Zero" and thus achieve integration of the input signal from the set value
- range of the setting is 0...100 000
- **DEF** = 0

#### 6.2.3d Selection of the type of integration

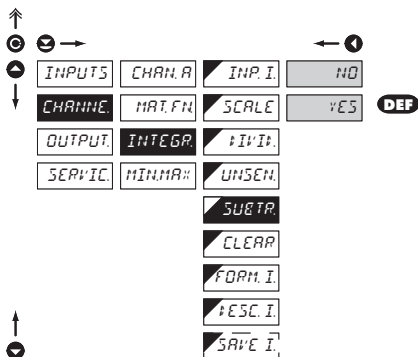

#### **SUBTR.** Selection of the type of integration

- the selection allows to suppress the negative value of input signal, i.e. the instrument integrates only in positive values (adds up)

- NO** Subtraction is off
- YES** Subtraction enabled

## 6.2.3e Selection of automatic resetting

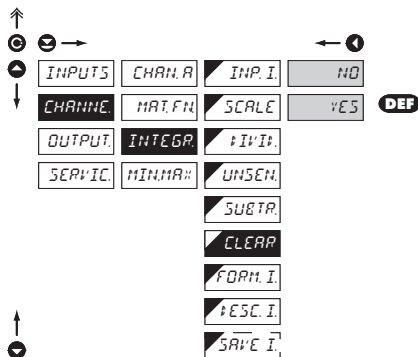
**CLEAR** Selection of automatic resetting to zero

- in this step it is possible to allow automatic resetting upon display overflow

NO Automatic resetting is off

- upon display overflow error statement is displayed

YES Automatic resetting is enabled

- upon display overflow the instrument is automatically reset to zero and proceeds in continuous measuring

## 6.2.3f Selection of projection format

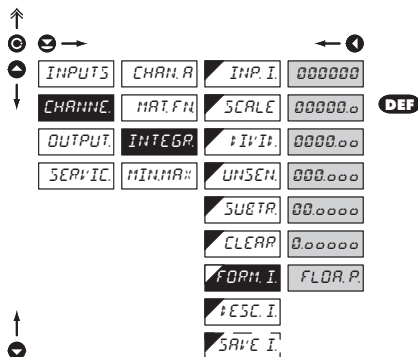
**FORM. I** Selection of decimal point

- the instrument allows for classic projection of a number with positioning of the DP as well as projection with floating DP, allowing to display a number in its most exact form „FLOAT.P.“

000000 Setting DP - XXXXXX.

00000.0 Setting DP - XXXXX.x

0000.00 Setting DP - XXXX.xx

000.000 Setting DP - XXX.xxx

00.00000 Setting DP - XX.xxxxx

0.000000 Setting DP - X.xxxxxx

FLOAR. P. Floating DP

#### 6.2.3g Selection of projection of measuring units

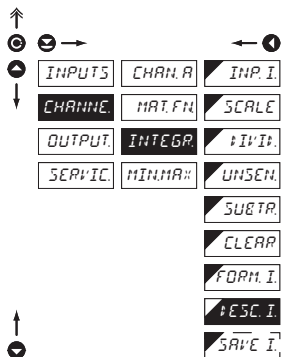

#### FESC. I Setting projection of descript. for Integrators

- projection of mesured data may be extended (at the expense of the number of displayed places) by two characters for description
- description is set by shifted ASCII code, when two first places show the set description and two last characters their code in period 0...95
- description is cancelled by code 00



Table of signs on page 79

#### 6.2.2h Selection of storing data into instrument memory

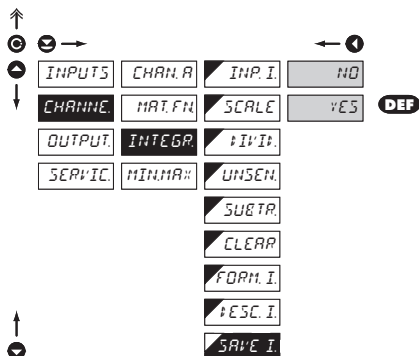

#### SAVE I. Selection of storing data into instrument memory

- by selection in this item you allow to register values into instrument memory
- another setting in item "OUTPUT. > MEMORY" (not in standard experiment)

YES

Measured data are stored in the memory

NO

Measured data are not stored

## 6.2.4 Selection of evaluation of min/max value

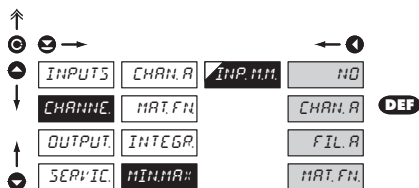
**INP.M.N.** Selection of evaluation of min/max value

- selection of value from which the min/max value will be calculated

**NO** Evaluation of min/max value is off

**CHAN.A.** From "Channel A"

**FIL.A.** From "Channel A" after digital filters processing

**MAT.FN.** From "Mathematic functions"



## 6.3 Setting „PROFI“ - OUTPUTS

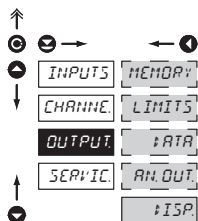

In this menu it is possible to set parameters of the instrument output signals

- MEMOR.** Setting data logging into memory
- LIMITS** Setting type and parameters of limits
- DATA** Setting type and parameters of data output
- AN. OUT.** Setting type and parameters of analog output
- DISP.** Setting display projection and brightness

### 6.3.1a Selection of mode of data logging into instrument memory

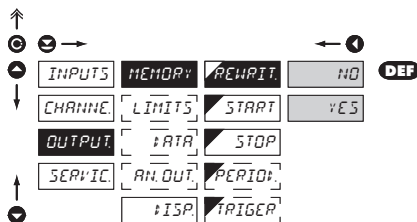

**REWRIT.** Selection of the mode of data logging

- selection of the mode in the event of full instrument memory

- NO** Rewriting values prohibited
- YES** Rewriting values permitted, the oldest get rewritten by the latest

#### 6.3.1b Setting data logging into instrument memory - RTC

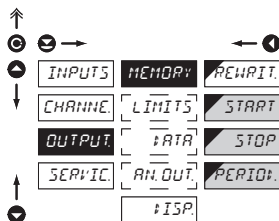

- START** Start of data logging into instrument memory  
- time format HH.MM.SS
- STOP** Stop data logging into instrument memory  
- time format HH.MM.SS
- PERIOD** Period of data logging into instrument memory  
- determines the period in which values will be logged in an interval delimited by the time set under items START and STOP  
- time data hold valid for one day, where the logging is valid for every day without limitation  
- time format HH.MM.SS  
- item not displayed if "STORE" is selected in menu (*Input > EXT. IN.*)

#### 6.3.1b Setting data logging into instrument memory - FAST

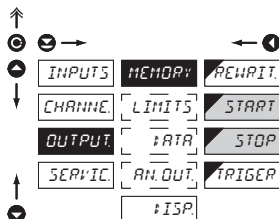

- START** Start of data logging into instrument memory
- STOP** Stop data logging into instrument memory  
- time format HH.MM.SS
- TRIGGER** Setting logging data into inst. memory

- values will be logged in an interval delimited by the time set under items START and STOP, time data hold valid for one day, where the logging is valid for every day without limitation
- logging data into inst. memory is governed by the following selection, which determines how many percent of the memory is reserved for data logging prior to initiation of trigger impulse
- initiation is on ext. input or control key

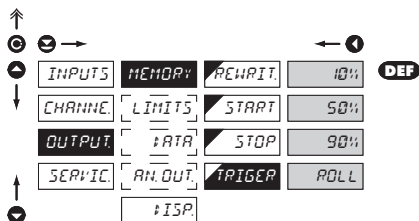

- 10%** Reser. of 10 % memory prior init. of data logging
- 50%** Reser. of 50 % memory prior init. of data logging
- 90%** Reser. of 90 % memory prior init. of data logging
- POLL** After initiation of data logging the memory is cyclically transcribed

## 6.3.2a Selection of input for limits evaluation

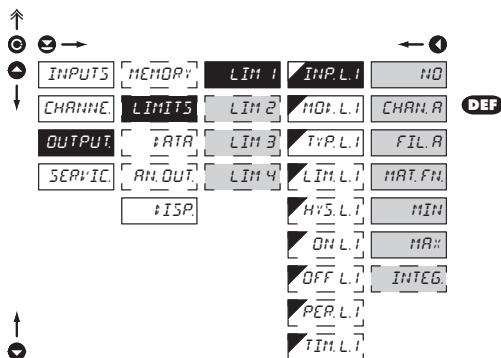
**INP. L.1** Selection evaluation of limits

- selection of value from which the limit will be evaluated

- NO** Limit evaluation is off
- CHAN. A** From "Channel A"
- FIL. A** From "Channel A" after digital filters processing
- MAT. FN.** From "Mathematic functions"
- MIN.** From "Min. value"
- MAX.** From "Max. value"
- INTEG.** From "Integrated value"

**!**  
Setting is identical for LIM 2, LIM 3 and LIM 4

## 6.3.2b Selection of type of limit

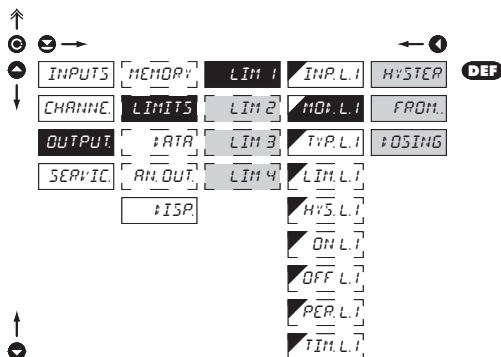
**MOD. L.1** Selection the type of limit

- HYSTER** Limit is in mode "Limit, hysteresis, delay"
- for this mode the parameters of "LIM. L." are set, at which the limit will shall react, "HYS. L." the hysteresis range around the limit ( $LIM \pm 1/2 HYS$ ) and time "TIM. L." determining the delay of relay switch-on
- FRDM..** Frame limit
- for this mode the parameters are set for interval "ON. L." the relay switch-on and "OFF. L." the relay switch-off
- DOSING** Dose limit (periodic)
- for this mode the parameters are set for "PER. L." determining the limit value as well as its multiples at which the output is active and "TIM. L." indicating the time during which is the output active

**!**  
Setting is identical for LIM 2, LIM 3 and LIM 4



#### 6.3.2c Selection of type of output

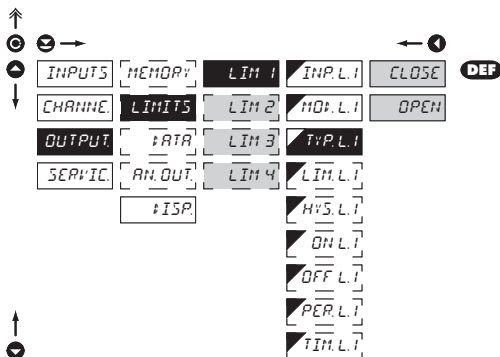

**TYP. L.1** Selection of type of output

- CLOSE** Output switches on when condition is met
- OPEN** Output switches off when condition is met

**!**  
Setting is identical for LIM 2, LIM 3 and LIM 4

#### 6.3.2d Setting values for limits evaluation

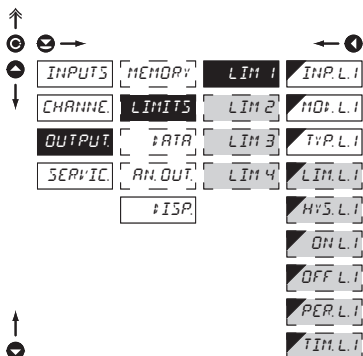

**LIM. L.1** Setting limit for switch-on

- for type "HYSTER"

**HYS. L.1** Setting hysteresis

- for type "HYSTER"
- indicates the range around the limit (in both directions, LIM.  $\pm 1/2$  HYS.)

**ON. L.1** Setting the outset of the interval of limit switch-on

- for type "FROM. ."

**OFF. L.1** Setting the end of the interval of limit switch-on

- for type "FROM. ."

**PER. L.1** Setting the period of limit switch-on

- for type "DOSING"

**TIM. L.1** Setting the time switch-on of the limit

- for type "HYSTER" and "DOSING"

**!**  
Setting is identical for LIM 2, LIM 3 and LIM 4

### 6.3.3a Selection of data output baud rate

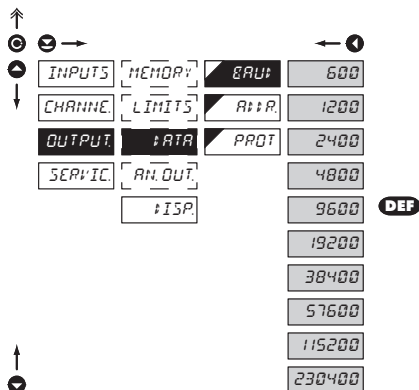

#### **BAUD** Selection of data output baud rate

600	Rate - 600 Baud
1200	Rate - 1 200 Baud
2400	Rate - 2 400 Baud
4800	Rate - 4 800 Baud
9600	Rate - 9 600 Baud
19200	Rate - 19 200 Baud
38400	Rate - 38 400 Baud
57600	Rate - 57 600 Baud
115200	Rate - 115 200 Baud
230400	Rate - 230 400 Baud

### 6.3.3b Setting instrument address

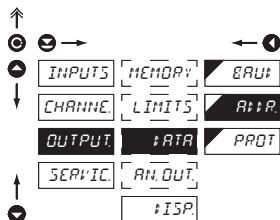

#### **A:R** Setting instrument address

- setting in range 0...31
- **DEF** = 00

#### 6.3.3c Selection of data output protocol

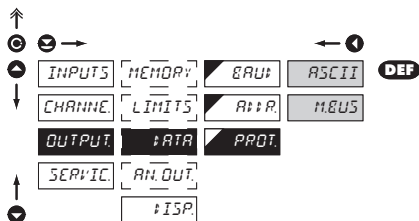

**PROT.** Selection of the type of analog output

**ASCII** Data protocol ASCII

**M.BUS** Data protocol DIN MessBus

#### 6.3.4a Selection of input for analog output

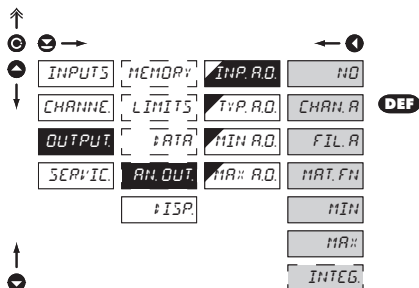

**INP. A.D.** Selection evaluation analog output

- selection of value from which the analog output will be evaluated

**NO** AO evaluation is off

**CHAN. A** From "Channel A"

**FIL. A** From "Channel A" after digital filters processing

**MAT. FN.** From "Math. functions"

**MIN.** From "Min. value"

**MAX.** From "Max. value"

**INTEG.** From "Integrated value"

### 6.3.4b Selection of the type of analog output

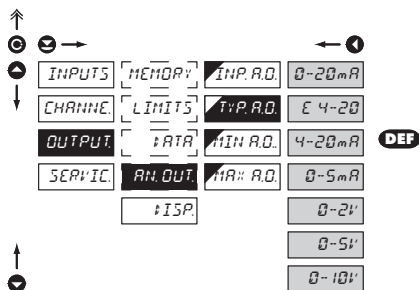

#### TYP. R.D. Selection of the type of analog output

0-20 mA Type - 0...20 mA

0-20 mA Type - 4...20 mA

- with indic. of error statement (< 3,0 mA)

4-20 mA Type - 4...20 mA

0-5 mV Type - 0...5 mA

0-2 V Type - 0...2 V

0-5 V Type - 0...5 V

0-10 V Type - 0...10 V

### 6.3.4c Setting the analog output range

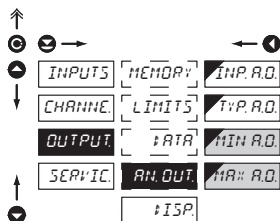

#### AN. OUT. Setting the analog output range

- analog output is isolated and its value corresponds with displayed data. It is fully programmable, i.e. it allows to assign the AO limit points to two arbitrary points of the entire measuring range

**MIN. R.D.** Assigning the display value to the beginning of the AO range

- range of the setting is -99999...999999

- **DEF** = 0

**MAX. R.D.** Assigning the display value to the end of the AO range

- range of the setting is -99999...999999

- **DEF** = 100

#### 6.3.5a Selection of input for display projection

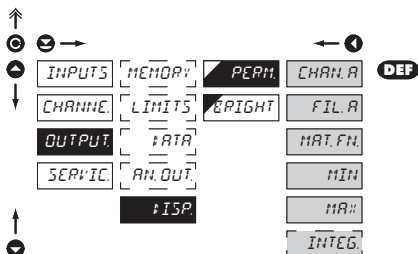

#### PERM. Selection display projection

- selection of value which will be shown on the instrument display

- CHAN. A** From "Channel A"
- FIL. A** From "Channel A" after digital filters processing
- MAT. FN.** From "Math. functions"
- MIN.** From "Min. value"
- MAX.** From "Max. value"
- INTEG.** From "Integrated value"

#### 6.3.5b Selection of display brightness

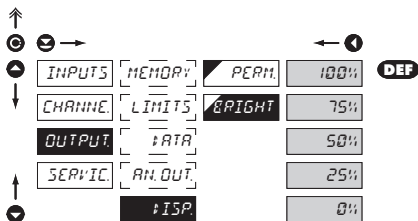

#### BRIGHT Selection of display brightness

- by selecting display brightness we may appropriately react to light conditions in place of instrument location

- 0%** Display is off
- after keystroke display turns on for 10 s
- 25%** Display brightness - 25%
- 50%** Display brightness - 50%
- 75%** Display brightness - 75%
- 100%** Display brightness - 100%

## 6.4 Setting "PROFI" - SERVICE

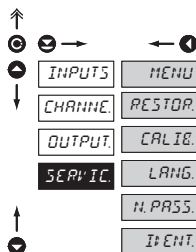

The instrument service functions are set in this menu

<b>MENU</b>	Selection of menu type LIGHT/PROFI
<b>RESTOR.</b>	Restore instrument manufacture setting and calibration
<b>CALIB.</b>	Automatic calibration of the input range
<b>LANG.</b>	Language version of instrument menu
<b>N.PASS.</b>	Setting new access password
<b>I:ENT.</b>	Instrument identification

### 6.4.1 Selection of type of programming menu

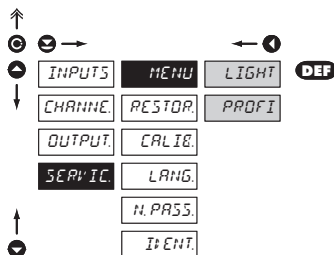

**MENU** Selection of menu type - LIGHT/PROFI

- enables setting the menu complexity according to user needs and skills

**LIGHT** Active LIGHT menu

- simple programming menu, contains only items necessary for configuration and instrument setting
- linear menu > items one after another

**PROFI** Active PROF I menu

- complete programming menu for expert users
- tree menu



Change of setting is valid upon next access into menu

#### 6.4.2 Restoration of manufacture setting

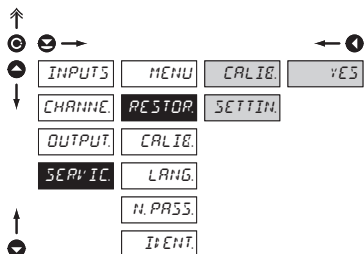

#### **RESTOR.** Restoring manufacture setting of the instrument

- in the event of erroneous setting or calibration it is feasible to restore manufacture setting. Prior execution of any changes you will be asked to confirm your preference „YES“

**CALIB.** Restore manufacture instrument calibration

**SETTIN.** Restore manufacture instrument setting

- loading manufacture setting (items denoted DEF)
- prior execution of changes you will be asked to confirm your preference “YES”

Jobs performed	Restore	
	Calibration	Setting
cancel USER menu rights	✓	✓
deletes table of items order in USER - LIGHT menu	✓	✓
adds items from manufacture to LIGHT menu	✓	✓
deletes data stored in FLASH	✓	✓
cancel or linearization tables	✓	✓
clears tare	✓	✓
clears conduct resistances	✓	✓
restore manufacture calibration	✓	x
restore manufacture setting	x	✓

## 6.4.3 Calibration - Input range

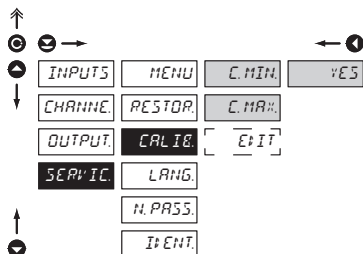
**CALIB.** Input range calibration

- prior performing any changes you will be asked to confirm your selection "YES"

**C. MIN** Calibration of the beginning of the measuring range

- prior confirmation of the selection the reference signal has to be connected

**C. MAX** Calibration of the end of the measuring range

- prior confirmation of the selection the reference signal has to be connected



After incorrect client calibration it is always possible to restore manufacture calibration ("SERVIC./

**Manual calibration:**

**MAX** Sensor range

**SENSE** Sensor sensitiveness

**Automatic calibration**

(after calibration in menu "SERVIC./CALIB."):

**MIN** Size of load with which minimum calibration was performed

**MAX** Size of load with which maximum calibration was performed

- upon maximum calibration we recommend the reference load value in the upper third of the measuring range

## 6.4.3a Calibration - modification of internal constants

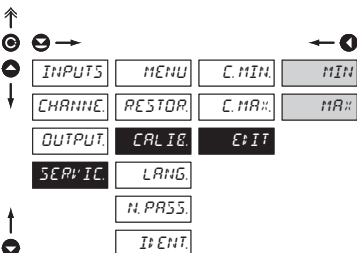
**EDIT** Modification of internal calibration constants

- this option is designed solely for contingent metrological examination and protocol
- item is available after aut. calibration

**MIN** Minimum calibration range

- range  $\pm 99.0000$

**MAX** Maximum calibration range

- range  $\pm 99.0000$



#### 6.4.4 Selection of instrument menu language version

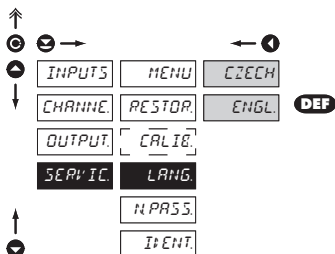

**LANG.** Selection of instrument menu language version

**CZECH** Instrument menu is in Czech

**ENGL.** Instrument menu is in English

#### 6.4.5 Setting new access password

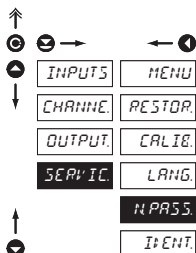

**N.PASS.** Setting new password for access to LIGHT and PROFI menu

- this selection enables changing number code that blocks the access into LIGHT and PROFI Menu.
- range of the number code is 0...9999
- universal password in the event of loss is „8177“

#### 6.4.6 Instrument identification

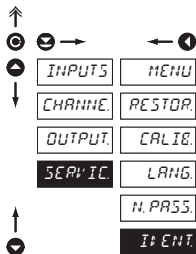

**I:ENT.** Projection of instrument SW version

- display shows type identification of the instrument, SW number, SW version and current input setting (Mode)
- if the SW version reads a letter on first position, it is a customer SW

## 7.0 Setting items into "USER" menu

- **USER** menu is designed for users who need to change only several items of the setting without the option to change the primary instrument setting (e.g. repeated change of limit setting)
- there are no items from manufacture permitted in **USER** menu
- on items indicated by inverse triangle  L I
- setting may be performed in **LIGHT** or **PROFI** menu, with the **USER** menu then overtaking the given menu structure

USER

Setting

profi light

uset

- For user operation
- Menu items are set by the user (Profi/Light) as per request
- Access is not password protected

## Setting

flashing legend - current setting is displayed



NO

item will not be displayed in USER menu

YES

item will be displayed in USER menu with editing option

SHOW

item will be solely displayed in USER menu

### Setting sequence of items in "USER" menu

In compiling USER menu from active LIGHT menu the items (max. 10) may be assigned a sequence, in which they will be projected in the menu



#### Example:

Into USER menu were selected these items

(keys + ) > CL. TAR., LIM 1, LIM 2, LIM 3, for which we have preset this sequence (keys + ):

CL. TAR.	5
LIM 1	0 (sequence not determined)
LIM 2	2
LIM 3	1

Upon entering USER menu

(key ) items will be projected in the following sequence: LIM 3 > LIM 2 > CL.TAR. > LIM 1

The instruments communicate via serial line RS232 or RS485. For communication they use the ASCII protocol. Communication runs in the following format:

ASCII: 8 bit, no parity, one stop bit  
 DIN MessBus: 7 bit, even parity, one stop bit

The transfer rate is adjustable in the instrument menu. The instrument address is set in the instrument menu in the range of 0 + 31. The manufacture setting always presets the ASCII protocol, rate of 9600 Baud, address 00. The type of line used - RS232 / RS485 - is determined by an output board automatically identified by the instrument. The commands are described in specification you can find at [www.orbit.merret.cz/rs](http://www.orbit.merret.cz/rs).

## DETAILED DESCRIPTION OF COMMUNICATION VIA SERIAL LINE

Activity	Data transferred										
Data solicitation (PC)	#	A	A	<CR>							
Data transmission (Instrument)	>	R	<SP>	D	D	D	D	D	(D)	(D)	<CR>
Command confirm. (Instr.) - OK	!	A	A	<CR>							
Command confirm. (Instr.) - Bad	?	A	A	<CR>							
Instrument identification	#	A	A	1Y	<CR>						
HW identification	#	A	A	1Z	<CR>						
One-time measurement	#	A	A	7X	<CR>						
Repeated measurement	#	A	A	8X	<CR>						

## LEGEND

#	35	23 <sub>H</sub>	Command beginning
A	A	0...31	Two signs of instrument address (sent in ASCII - tens and ones, e.g. "01", "99" universal
<CR>	13	0D <sub>H</sub>	Carriage return
<SP>	32	20 <sub>H</sub>	Space
D			Data - usually signs "0"... "9", " ", " ", " ", " "; (D) - DP. and (-) may prolong data
R	50 <sub>H</sub> ...57 <sub>H</sub>		Relay and Tare status
!	33	21 <sub>H</sub>	Positive command confirmation (ok)
?	63	3F <sub>H</sub>	Negative command confirmation (bad)
>	62	3E <sub>H</sub>	Beginning of the data transmitted

## RELAY, TARE

Sign	Relay 1	Relay 2	Tare	Change relay 3/4
P	0	0	0	0
Q	1	0	0	0
R	0	1	0	0
S	1	1	0	0
T	0	0	1	0
U	1	0	1	0
V	0	1	1	0
W	1	1	1	0
p	0	0	0	1
q	1	0	0	1
r	0	1	0	1
s	1	1	0	1
t	0	0	1	1
u	1	0	1	1
v	0	1	1	1
w	1	1	1	1



ERROR	CAUSE	ELIMINATION
$E. P. U_n$	Number is too small (large negative) to be displayed	change DP setting, channel constant setting
$E. P. O_n$	Number is too large to be displayed	change DP setting, channel constant setting
$E. T. U_n$	Number is outside the table range	increase table values, change input setting (channel constant setting)
$E. T. O_n$	Number is outside the table range	increase table values, change input setting (channel constant setting)
$E. I. U_n$	Input quantity is smaller than permitted input quantity range	change input signal value or input (range) setting
$E. I. O_n$	Input quantity is larger than permitted input quantity range	change input signal value or input (range) setting
$E. HH$	A part of the instrument does not work properly	send the instrument for repair
$E. EE$	Data in EEPROM corrupted	perform restoration of manufacture setting, upon repeated error statement send instrument for repair
$E. P. ATN$	Data in EEPROM outside the range	perform restoration of manufacture setting, upon repeated error statement send instrument for repair
$E. CLR$	Memory was empty (presetting carried out)	upon repeated error statement send instrument for repair, possible failure in calibration

The instrument allows to add two descriptive characters to the classic numeric formats (at the expense of the number of displayed places). The setting is performed by means of a shifted ASCII code. Upon modification the first two places display the entered characters and the last two places the code of the relevant symbol from 0 to 95. Numeric value of given character equals the sum of the numbers on both axes of the table.

Description is cancelled by entering characters with code 00

0	0	1	2	3	4	5	6	7	0	1	2	3	4	5	6	7	
8	(	)	*	+	,	-	.	/	8	(	)	*	+	,	-	.	/
16	0	1	2	3	4	5	6	7	16	0	1	2	3	4	5	6	7
24	8	9	:	;	<	=	>	?	24	8	9	:	;	<	=	>	?
32	@	A	B	C	D	E	F	G	32	@	A	B	C	D	E	F	G
40	H	I	J	K	L	M	N	O	40	H	I	J	K	L	M	N	O
48	P	Q	R	S	T	U	V	W	48	P	Q	R	S	T	U	V	W
56	X	Y	Z	[	\	]	^	_	56	X	Y	Z	[	\	]	^	_
64	`	a	b	c	d	e	f	g	64	`	a	b	c	d	e	f	g
72	h	i	j	k	l	m	n	o	72	h	i	j	k	l	m	n	o
80	p	q	r	s	t	u	v	w	80	p	q	r	s	t	u	v	w
88	x	y	z	{		}	~		88	x	y	z	{		}	~	

**INPUT**

range is fixed, as per order

Range:	±99,999 mV	>1,8 MOhm
	±999,99 mV	1,8 MOhm
	±9,9999 V	1,8 MOhm
	±99,999 V	1,8 MOhm
	±300,00 V	1,8 MOhm
	±999,99 mA	< 300 mV
	±9,9999 mA	< 300 mV
	±99,999 mA	< 300 mV
	±999,99 mA	< 50 mV
	±5,0000 A	< 50 mV

**DC**

Input U  
Input U  
Input U  
Input U  
Input U  
Input I  
Input I  
Input I  
Input I  
Input I

range is adjustable

0...5 mA	< 300 mV
0...20 mA	< 300 mV
4...20 mA	< 300 mV
±2 V	1,8 MOhm
±5 V	1,8 MOhm
±10 V	1,8 MOhm

**PM**

Input I  
Input I  
Input I  
Input U  
Input U  
Input U

Number of inputs: 2, two inputs I and U are set as a standard

range is adjustable

0...5 mA	< 300 mV
0...20 mA	< 300 mV
4...20 mA	< 300 mV
±2 V	1,8 MOhm
±5 V	1,8 MOhm
±10 V	1,8 MOhm

**I**

Input I  
Input I  
Input I  
Input U  
Input U  
Input U

Number of inputs: 2, two inputs I and U are set as a standard

Time base: 1 s

Projection: immediate (±99999)  
accrued (999999)

range is adjustable

0...5 mA	< 300 mV
0...20 mA	< 300 mV
4...20 mA	< 300 mV
±2 V	1,8 MOhm
±5 V	1,8 MOhm
±10 V	1,8 MOhm

**LX**

Input I  
Input I  
Input I  
Input U  
Input U  
Input U

Number of inputs: 2, two inputs I and U are set as a standard

Linearization: linear interpolation in 256 points

Number of tables: 16

**DU**Voltage of lin. pot. 2,5 VDC/6 mA  
min. potentiometer resistance is 500 Ohm

range is fixed, as per order

Sensitivity:	1...4 mV/V
	2...8 mV/V
	4...16 mV/V

Connection: 4/6-wire

Tensiometer voltage: 10 VDC, max. load 65 Ohm

**PROJECTION**

Display:	999999, intensive red or green 14-ti segment LED, digit height 14 mm
Projection:	±99999 (-99999...999999)
Decimal point:	adjustable - in menu
Brightness:	adjustable - in menu

**INSTRUMENT ACCURACY**

TC:	60 ppm/°C
Accuracy:	±0,05 % of range + 1 digit
	±0,1 % of range + 1 digit

**DU, T**  
**Above accuracies apply for projection 99999**

Rate: 0,1...100 measurements/s

Overload capacity: 10x (t < 100 ms) not for 400 V and 5 A,  
2x (long-term)Linearisation: by linear interpolation in 50 points  
- solely via OM LinkDigital filters: Averaging, Floating average, Exponential filter,  
Rounding

Functions:

- Tare - display resetting
- Hold - stop measuring (at contact)
- Lock - control key locking
- MM - min/max value
- Mathematic functions

OM Link: company communication interface for setting,  
operation and update of instrument SW

Watch-dog: reset after 400 ms

Calibration: at 25°C and 40 % of r.h.

**COMPARATOR**

Type:	digital, adjustable in menu
Mode:	Hysteresis, From, Dose
Limits:	-99999...999999
Hysteresis:	0...999999
Delay:	0...99,9 s
Outputs:	2x relays with switch-on contact (Form A) (230 VAC/30 VDC, 3 A)* 2x relays with switch-off contact (Form C) (230 VAC/50 VDC, 3 A)*
Relay:	1/8 HP 277 VAC, 1/10 HP 125 V, Pilot Duty D300

\* values apply for resistance load



**DATA OUTPUTS**

Protocols:	ASCII, DIN MessBus
Data format:	8 bit + no parity + 1 stop bit (ASCII) 7 bit + even parity + 1 stop bit (MessBus)
Rate:	600...230 400 Baud
RS 232:	isolated, two-way communication
RS 485:	isolated, two-way communication, addressing (max. 31 instruments)
PROFIBUS	Data protocol SIEMENS

**ANALOGO OUTPUTS**

Type:	isolated, programmable with resolution of max. 10 000 points, analog output corresponds with displayed data, type and range are adjustable
Non-linearity:	0,2% of range
TC:	100 ppm/°C
Rate:	response to change of value < 40 ms
Voltage:	0...2 V/5 V/10 V
Current:	0...5/20 mA/4...20 mA - compensation of conduct to 500 Ohm

**MEASURED DATA RECORD**

Type RTC:	time-controlled logging of measured data into instrument memory, allows to log up to 250 000 values
Type FAST:	fast data logging into instrument memory, allows to log up to 8 000 values at a rate of 40 records/s
Transmission:	via data output RS 232/485 or via OM Link

**EXCITATION**

Adjustable:	5...24 VDC/max. 1,2 W, isolated
-------------	---------------------------------

**POWER SUPPLY**

Options:	10...30 V AC/DC, 10 VA, isolated, - fuse inside (T 4000 mA) 80...250 V AC/DC, 10 VA, isolated - fuse inside (T 630 mA)
----------	---

**MECHANIC PROPERTIES**

Material:	Noryl GFN2 SE1, incombustible UL 94 V-1
Dimensions:	96 x 48 x 120 mm
Panel cut-out:	90,5 x 45 mm

**OPERATING CONDITIONS**

Connection:	connector terminal board, conductor cross-section <1,5 mm <sup>2</sup> / <2,5 mm <sup>2</sup>
Stabilisation period:	within 15 minutes after switch-on
Working temp.:	0°...60°C
Storage temp.:	-10°...85°C
Cover:	IP65 (front panel only)
Construction:	safety class I
Overvoltage category:	EN 61010-1, A2
Insulation resistance:	for pollution degree II, measurement category III AC instrum. power supply > 670 V (PI), 300 V (DI) DC instrum. power supply > 300 V (PI), 150 V (DI) Input/output > 300 V (PI), 150 (DI)
EMC:	EN 61000-3-2+A12; EN 61000-4-2, 3, 4, 5, 8, 11; EN 550222, A1, A2

Front view



Panel cut

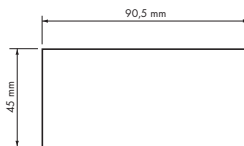

Side view

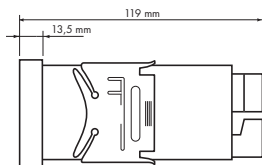

Panel thickness: 0,5...20 mm

### Instrument installation

1. insert the instrument into the panel cut-out
2. fit both travellers on the box
3. press the travellers close to the panel

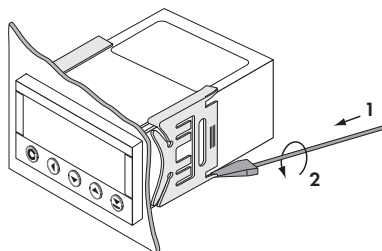
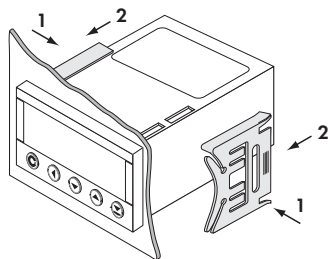

### Instrument disassembly

1. slide a screw driver under the traveller wing
2. turn the screw driver and remove the traveller
3. take the instrument out of the panel

Product **OM 502** DC PM I LX DU T  
 Type .....  
 Manufacturing No. ....  
 Date of sale .....

**GUARANTEE**

A guarantee period of 24 months from the date of sale to the user applies to this instrument.

Defects occurring during this period due to manufacture error or due to material faults shall be eliminated free of charge.

For quality, function and construction of the instrument the guarantee shall apply provided that the instrument was connected and used in compliance with the instructions for use.

The guarantee shall not apply to defects caused by:

- mechanic damage
- transportation
- intervention of unqualified person incl. the user
- unavoidable event
- other unprofessional interventions

The manufacturer performs guarantee and post.guarantee repairs unless provided for otherwise.

**Y E A R S**

Stamp, signature

# DECLARATION OF CONFORMITY

**Company:** **ORBIT MERRET, spol. s r.o.**  
Klánská 81/141, 142 00 Prague 4, Czech Republic, IDNo: 00551309

**Manufactured:** **ORBIT MERRET, spol. s r.o.**  
Vodňanská 675/30, 198 00 Prague 9, Czech Republic

declares at its full responsibility that the product presented hereunder meets all technical requirements, is safe for use when utilised under the terms and conditions determined by ORBIT MERRET, spol.s r.o. and that our company has taken all measures to ensure conformity of all products of the type listed hereunder, which are being brought out to the market, with technical documentation and requirements of the appurtenant statutory orders.

**Product:** 5-digit programmable panel instrument

**Type:** **OM 502**

**Version:** DC, PM, I, LX, DU, T

Conformity is assessed pursuant to the following standards:

El. safety: EN 61010-1  
EMC: EN 50131-1, chapter 14 and chapter 15  
EN 50130-4, chapter 7 EN 61000-4-11  
EN 50130-4, chapter 8 EN 61000-4-11  
EN 50130-4, chapter 9 EN 61000-4-2  
EN 50130-4, chapter 10 EN 61000-4-3  
EN 50130-4, chapter 11 EN 61000-4-6  
EN 50130-4, chapter 12 EN 61000-4-4  
EN 50130-4, chapter 13 EN 61000-4-5  
EN 50130-5, chapter 20  
prEN 50131-2-1, par. 9.3.1  
EN 61000-4-8  
EN 61000-4-9  
EN 61000-3-2 ed. 2:2001  
EN 61000-3-3: 1997, Cor. 1:1998, Z1:2002  
EN 55022, chapter 5 and chapter 6

and Ordinance on:

El. safety: No. 168/1997 Coll.  
EMC: No. 169/1997 Coll.

The evidence are the protocols of authorized and accredited organizations:

VTÚE Praha, experimental laboratory No. 1158, accredited by ČIA  
VTÚPV Vyškov, experimental laboratory No. 1103, accredited by ČIA

Place and date of issue: Prague, 18. April 2006

Miroslav Hackl v.r.  
Company representative

*Mode of asses. of conformity §12, par. 4 b, d Act No. 22/1997 Coll.*