



OM 371

3 3/4 DIGIT PROGRAMMABLE

DC VOLTMETER/AMMETER

PROCESS MONITOR

OHMMETER

THERMOMETER FOR PT 100/500/1 000

THERMOMETER FOR NI 1 000/2 226/10 000

THERMOMETER FOR THERMOCOUPLES

DISPLAY INSTRUMENT FOR LIN.

POTENTIOMETERS

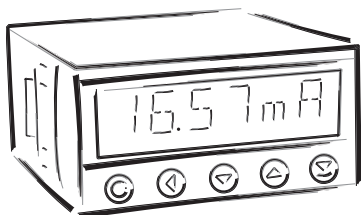

SAFETY INSTRUCTIONS

Please, read the enclosed safety instructions carefully and observe them!
These instruments should be safeguarded by isolated or common fuses (breakers)!
For safety information the EN 61 010-1 + A2 standard must be observed.
This instrument is not explosion-safe!

TECHNICAL DATA

Measuring instruments of the OM 371 series conform to European regulation 89/336/EWG and Ordinance 168/1997 Coll.

They are up to the following European standards:

EN 55 022, class B

EN 61000-4-2, -4, -5, -6, -8, -9, -10, -11

The instruments are applicable for unlimited use in agricultural and industrial areas.

CONNECTION

Power supply from the main line has to be isolated from the measuring leads.



ORBIT MERRET, spol. s r.o.

Vodnanska 675/30

198 00 Prague 9

Czech Republic

Tel: +420 - 281 040 200

Fax: +420 - 281 040 299

e-mail: orbit@merret.cz

www.orbit.merret.cz



1. CONTENTS

1.	Contents	3
2.	Instrument description	4
3.	Connection	6
4.	Setting	8
	Programming modes	8
	Control keys functions	8
	Setting the DP and the (-) sign	9
4.1	Guide through minimum instrument setting, calibration	10
4.2	User menu	12
4.3	Configuration menu	15
4.3.1	Configuration mode - MENU	
4.3.1.1	Setting the limits	16
4.3.1.2	Setting the analog output	17
4.3.1.3	Setting the data output	17
4.3.1.4	Setting the display brightness	18
4.3.1.3	Tare resetting	18
4.3.2	Configuration mode - CONFIG	
4.3.2.1	Configuration and access rights for the limits	19
4.3.2.2	Configuration and access rights for the analog output	20
4.3.2.3	Access rights for data output	21
4.3.2.4	Access rights for brightness setting	21
4.3.2.5	Access rights for tare resetting	21
4.3.3	Configuration mode - INPUT	
4.3.3.1	Projection on the display (DC, PM, OHM)	23
4.3.3.2	Shifting the beginning of the range (RTD)	23
4.3.3.3	Compensation of 2-wire conduct (RTD, OHM)	24
4.3.3.4	Setting the type of connection (RTD)	24
4.3.3.5	Setting the temperature of the cold junction (T/C)	24
4.3.3.6	Setting the method of measuring of the cold junction (T/C)	25
4.3.3.7	Setting the digital filter	25
4.3.3.8	Setting the measuring range (DC, PM, OHM, RTD, T/C)	26
4.3.3.9	Setting the measuring rate	27
4.3.3.10	Projection of measuring units	27
5.	Input configuration - setting the jumpers	28
6.	Table of symbols	29
7.	Method of measuring of the cold junction	30
8.	Data protocol	32
9.	Error statements	34
10.	Instrument dimensions and installation	35
11.	Technical data	36
12.	Declaration of conformity	38
13.	Certificate of guarantee	39

2. INSTRUMENT DESCRIPTION

DESCRIPTION

The OM 371 model series are 3 3/4 digit panel instruments, manufactured in the following alternatives:

OM 371 DC	DC voltmeter/ammeter
OM 371 PWR	*Nets analyser - AC voltmeter/ammeter/wattmeter
OM 371 PM	Process monitor
OM 371 RTD	Thermometer for Pt 100/500/1 000, Ni 1 000/2 226/10 000
OM 371 T/C	Thermometer for thermocouples
OM 371 DU	Display instrument for linear potentiometers
OM 371 OHM	Ohmmeter

The instruments are based on an 8-bit microcontroller with precise A/D converter, that secures high accuracy, stability and easy operation of the instrument.

Programmable projection of the display

Calibration	projection for the beginning and the end of the input range setting the type of input
Projection	-999...3999

Digital filters

Radius of insensitiveness adjustable in process units

Mathematic functions

Tare	assigned to reset the display in case of non-zero input signal
------	----------------------------------------------------------------

External control

Hold	display/instrument blocking
Lock	locking the control keys or the access into Configuration menu

Output

Limits	2 relays with switching contact, Limits have both adjustable hysteresis and optional delay of the switch-on. Reaching the limits is signalled by LED and at the same time by the switch-on of the relevant relay.
--------	----------------------------------------------------------------------------------------------------------------------------------------------------------------------------------------------------------------------

* These instruments have separate Instructions for use

OPERATION

The instrument is set and controlled by five control keys located on the front panel. All programmable settings of the instrument are realised in two adjusting modes:

- Configuration menu** (hereinafter referred to as „CM“) is protected by an optional numeric code and contains complete instrument setting
- User menu** may contain arbitrary programming setting defined in CM with another selective restriction (see, change)

All programmable parameters are stored in the EEPROM memory (they hold even after the instrument is switched off).

The measured units may be projected on the display.

EXTENSION

Excitation is suitable for feeding of sensors and converters. It has a galvanic isolation with continuously adjustable value in the range of 2...24 VDC

Data outputs are for their rate and accuracy suitable for transmission of measured data for further projection or directly into the control systems. We offer isolated RS232 and RS485 with the ASCII protocols.

Analog outputs will find their place in applications where further evaluating or processing of measured data in external devices is required. We offer universal analog output with the option of selection of the output type - voltage/current. The analog output value corresponds with the displayed data and its type and range are selectable in the programming mode.

3. CONNECTION

The supply lead for feeding the instrument should not be in the proximity of low-potential signals.
 Contactors, motors with larger input and other efficient elements should not be in the proximity of the instrument.
 The lead into the instrument input (the measured quantity) should be in sufficient distance from all power leads and appliances. Provided this cannot be secured, it is necessary to use shielded leads with connection to ground.
 The instruments are tested in compliance with standards for use in industrial area, yet, we recommend to abide by the above mentioned principles.

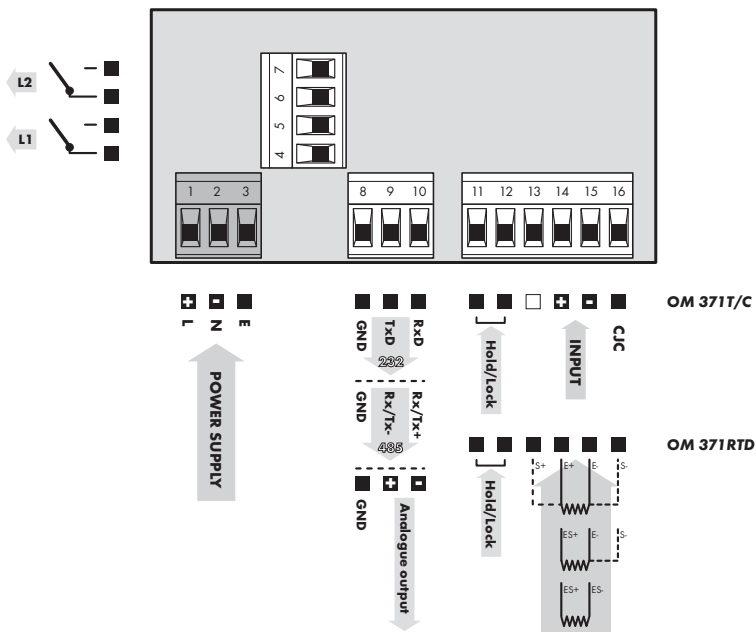

! Grounding on terminal „E“ must be connected at all times

! In RTD input with 2- or 3-wire connection it is necessary to link the unconnected inputs (13/14 and 15/16 or 15/16)

! Relay parameters specified in the technical data apply for resistance load. Upon connection of the induction load we recommend to fit the leads to relay 1 A with a fuse for maximum load protection.

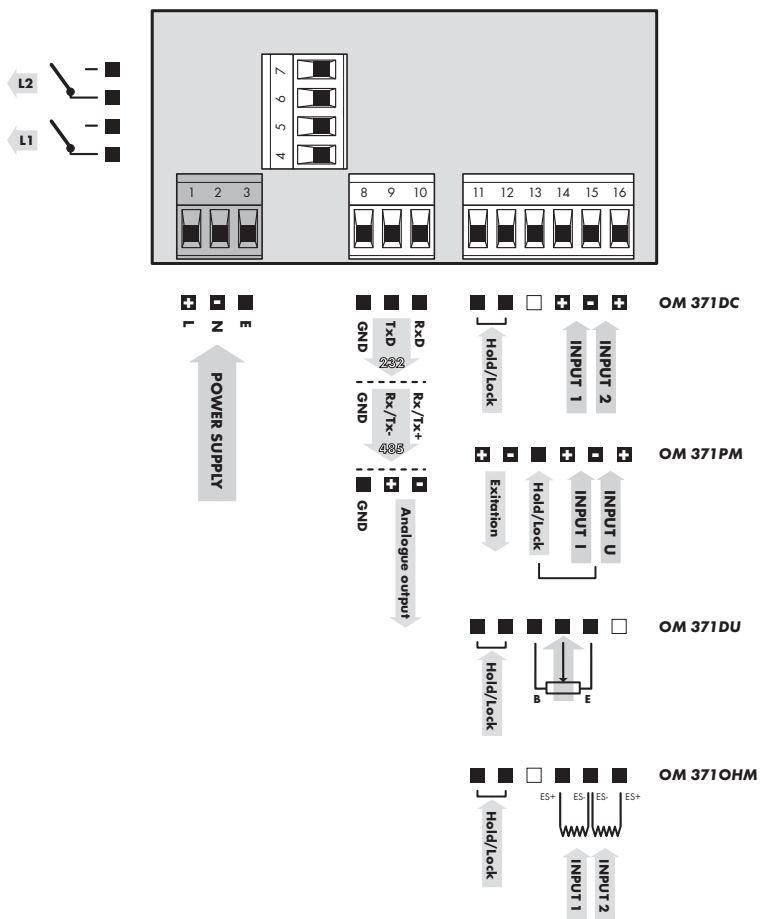

MEASURING RANGES

Type	Input 1 (I)	Input 2 (U)
OM 371 DC - U	0...60/150/300 mV	0...4/40/400 V
OM 371 DC - I	0...1/5 A	0...400 mA
OM 371 PM	0/4...20 mA	0...2/5/10 V
OM 371 OHM	0...0,4/4/40 kOhm	5...105 Ohm, (upon request 0...100 kOhm)

4. INSTRUMENT SETTING

The instrument is set and controlled by 5 control keys located on the front panel. By means of these control keys it is possible to browse through the operating program, to select and set the required values.

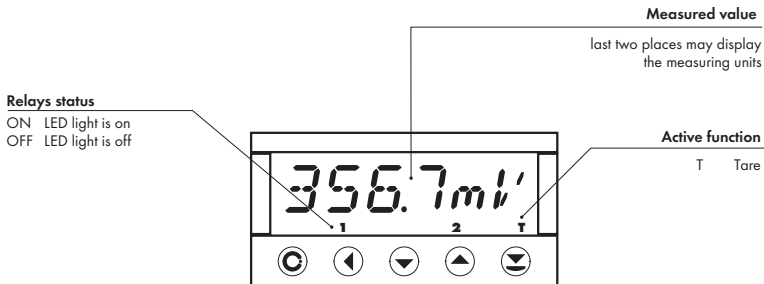

CONFIGURATION MODE

- designated for professional service and maintenance
- complete instrument setting
- access is password protected
- authorization for "User mode"

USER MODE

- designated for instrument service
- may contain setting the limits, analog and data output and brightness, with restriction as per the setting in "Configuration mode"

SYMBOLS USED IN THE INSTRUCTIONS

DC **PM** **DU** **OHM** **RTD** **T/C**



Indicates the setting for given type of instrument

CONTROL KEYS FUNCTIONS

MENU	ENTER	LEFT	DOWN	UP
Measuring mode				
menu access	tare	tare projection		
Moving around in the menu				
exit the menu without saving	move to next level	back to previous level		move to next item
Setting/selecting - items				
cancel setting without saving	confirm selected item		move down	move up
Setting - numbers				
cancel setting without saving	cancel selected number	move to higher decade	change of current figure - down -	change of current figure - up -

SETTING THE DECIMAL POINT AND THE MINUS SIGN

DECIMAL POINT

Its selection in calibration modes, upon modification of the number to be adjusted is performed by the control key  with transition behind the highest decade, when the decimal point starts flashing. Positioning is performed by . Decimal point is set only in the item „Input - MIN“





MINUS SIGN

It is adjustable upon the shift of the decimal point across all decades, back to the first one, at which the minus sign will light up. The setting is repeated, i.e. 1x around only positioning of the decimal point and upon next passage across all decades the minus sign lights up and the decimal point is placed.



Setting

⇒ „Calibration mode“ ⇒ Input ⇒ Minimum
⇒ INPUT ⇒ MIN

⇒ after transition behind the highest decade  the decimal point starts flashing
⇒ by pressing  or  you will place the decimal point and confirm it by 

! In the MIN item the setting of the decimal point is determining for the entire instrument

ACCESS INTO THE CONFIGURATION MODE

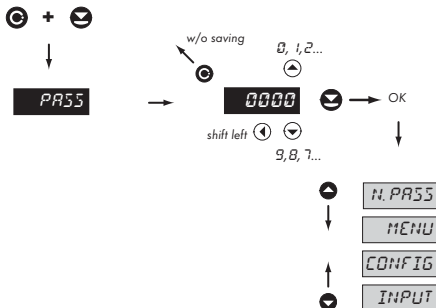

 The code is always preset from manufacture to 0000. In case of loss of access password it is possible to use universal access code "8177"

4.1 GUIDE THROUGH MINIMUM INSTRUMENT SETTING

1 Access into the „Configuration menu“

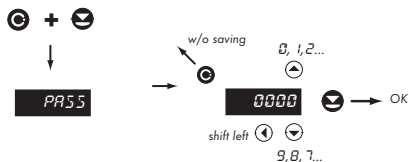

PASS Entering the introductory access password

0000 Standard manufacture setting of the access password

2 Selection of the meas. range/type of input

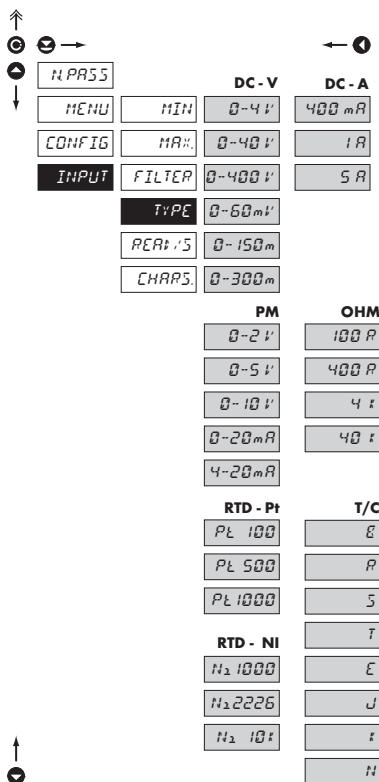

DC **PM** **OHM** **RTD** **T/C**

TYPE Setting the instrument measuring range

DC Input

- ammeter and voltmeter are two independent instruments

PM Input

- setting the measuring range

RTD Input

- setting the type of sensor
 - Pt 3850 ppm/°C EU, standard
 - Pt 3920 ppm/°C US, upon request
 - Ni 5000 ppm/°C standard
 - Ni 6180 ppm/°C upon request

OHM Input

- setting the measuring range

100 R	5...105 Ohm
(100 K	0...100 kOhm), upon request
400 R	0...400 Ohm
4 K	0...4 kOhm
40 K	0...40 kOhm

T/C Input

- setting the type of thermocoupler

B	type B
R	type R
S	type S
T	type T
E	type E
J	type J
K	type K
N	type N

3 Setting projection on the display

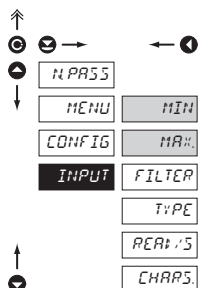

INPUT Setting the input parameters

- items necessary for minimum instrument setting

Type of input	Displayed items of the menu
DC	MIN, MAX
PM	MIN, MAX
DU	MIN, MAX
OHM	MIN, MAX, *LEADS
RTD	*LEADS, CONNec.
T/C	CJC, COMP.TC

* only for 2-wire

4.2 USER MENU

- designated for instrument service
- may contain setting the limits, analog/data output and brightness, with restriction as per the setting in "Configuration mode"

23.6



MENU

LIMITS

ANALOG

DATA

BRIGHT.

CLPTAR.

MENU

Setting limits, hysteresis and delay

Setting the analog output

Setting the data output

Setting the display brightness

Tare resetting

Instrument setting

! Projection of items and their accessibility depends on the setting of access rights in the „Configuration menu“

4.2.1 LIMITS - ENTERING THE VALUES

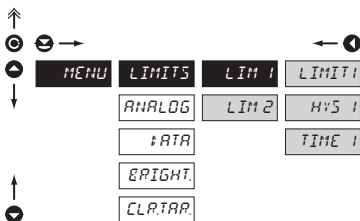

LIMITS Entering the limit values for status evaluations

LIM 1 Setting for Limit 1

LIM 2 Setting for Limit 2

LIMIT 1 Setting the limit for relay switch-on

- in full range of the display

HYS 1 Setting hysteresis only in (+) values

- in 1/10 of the display range

TIME 1 Setting the delay of relay activation

- in the range of 0...99,9 s

Adjustable authorization of access into items, see page 19

4.2.2 ANALOG OUTPUT

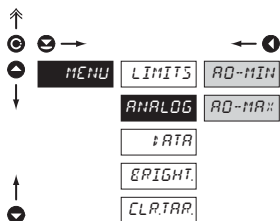

Adjustable authorization of access into items, see page 20

Analog and data outputs may not be fitted simultaneously in this instrument

ANALOG Setting the analog output range

- analog output is isolated and its value corresponds with the displayed data. It is fully programmable, i.e. it allows to assign the AO limit points to any two arbitrary points of the entire measuring range

AO-MIN Assigning the displayed value to the beginning of the analog output range

- range of the setting is -999...3999

AO-MAX Assigning the displayed value to the end of the analog output range

- range of the setting is -999...3999

4.2.3 DATA OUTPUT

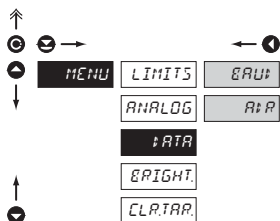

Adjustable authorization of access into items, see page 21

DATA Setting the data output parameters

BAUD Setting the transmission rate (baud)

- setting in the range of 150/300/600/1200/2400/4800/9600/19200/38400/57600/115200 Baud

A:P Setting the instrument address

- setting in the range of 0...31
- manufacture setting 00 **DEF**

4.2.4 DISPLAY BRIGHTNESS

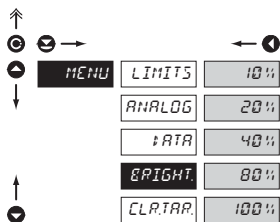

BRIGHT. Setting the display brightness

- by selecting the display brightness we may properly react to light conditions in place of location of the instrument
- brightness in the programming menu is always 80%

Adjustable authorization of access into items, see page 21

4.2.5 TARE RESETTING

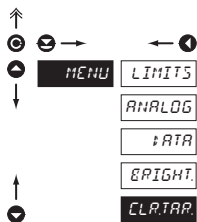

CLR.TAR. Tare resetting

- after confirmation the tare will be reset to zero and the LED „T“ will turn off

 Adjustable authorization of access into items, see page 21

4.3 CONFIGURATION MENU

- designated for professional service and maintenance
- complete instrument setting
- the access is protected by a password or a jumper on the input connector
- authorization for "User mode"

! Upon delay longer than 15 s the programming mode is automatically discontinued and the instrument itself switches back to the measuring mode

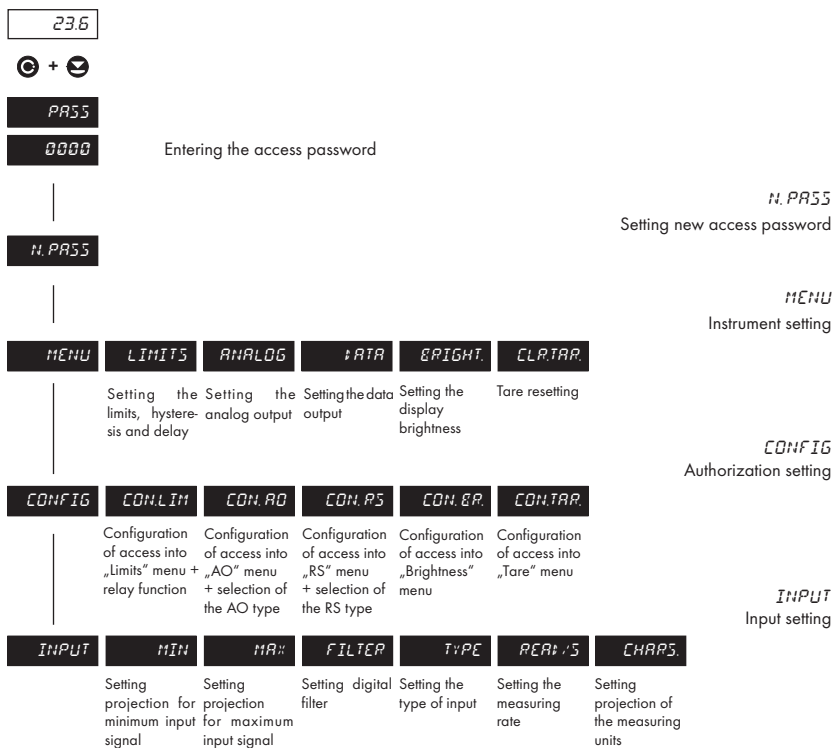

4.3.1 CONFIGURATION MODE - MENU

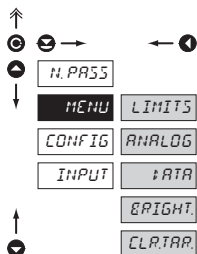

The basic instrument parameters are adjusted in this menu

LIMITS	Setting the limit values for status evaluation
ANALOG	Setting the analog output range
I.ATA	Setting the data output parameters
ERIGHT	Setting the display brightness
CLP.TAR	Tare resetting

4.3.1.1 LIMITS

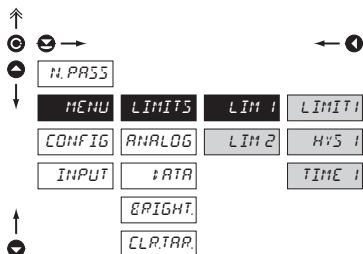

LIMITS Entering the limit values for status evaluation

LIM 1	Setting for Limit 1
LIM 2	Setting for Limit 2

LIMIT1 Setting the limit for relay switch-on

- in full range of the display

HYS 1 Setting hysteresis only in (+) values

- in 1/10 of the display range

TIME 1 Setting the delay for relay activation

- in the range of 0...99,9 s

! The procedure of setting the limit 2 is identical as for limit 1

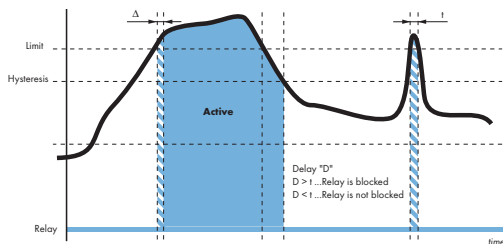

4.3.1.2 ANALOG OUTPUT

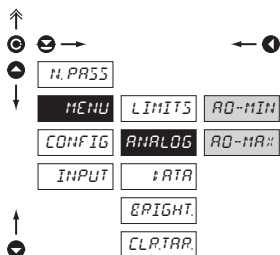
**ANALOG** Setting the analog output range

- analog output is isolated and its value corresponds with the displayed data. It is fully programmable, i.e. it allows to assign the AO limit points to any two arbitrary points of the entire measuring range

AO-MIN Assigning the displayed value to the beginning of the AO range

- range of the setting is -999...3999

AO-MAX Assigning the displayed value to the end of the AO range

- range of the setting is -999...3999

! Analog and data outputs may not be fitted simultaneously in this instrument

4.3.1.3 DATA OUTPUT

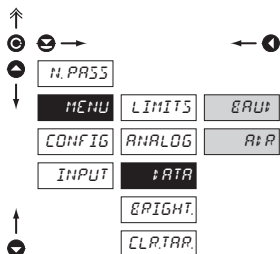
**I:ATA** Setting the data output parameters

ERATE Setting the transmission rate (baud)

- setting in the range of 150/300/600/1200/2400/4800/9600/19200/38400/57600/115200 Baud

R:R Setting the instrument address

- setting in the range of 0...31

- manufacture setting 00 **DEF**

! Analog and data outputs may not be fitted simultaneously in this instrument

4.3.1.4 DISPLAY BRIGHTNESS

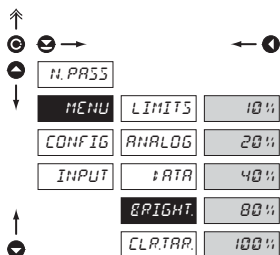
**BRIGHT** Setting the display brightness

- by selecting the display brightness we may react properly to light conditions in place of location of the instrument
- brightness in the programming menu is always 100%

10%	Display brightness = 10%
20%	Display brightness = 20%
40%	Display brightness = 40%
80%	Display brightness = 80%
100%	Display brightness = 100%

4.3.1.5 TARE RESETTING

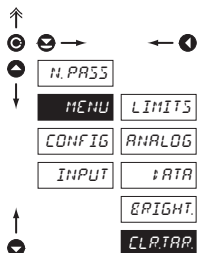
**CLRTAR** Tare resetting

- after confirmation the tare will be reset to zero and the LED „T“ will turn off

4.3.2 CONFIGURATION MODE - CONFIG

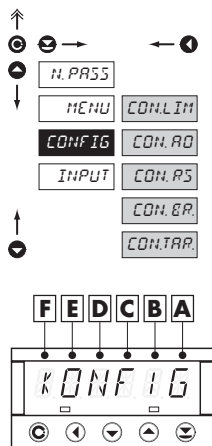

 The configuration code may consist of up to 6 numbers, which determine the operational setting of the instrument. Individual meaning and setting of the numbers are described in relevant chapters of the configuration mode.

CON.FIG Setting the access rights to individual options for „User mode“

- one of the prime merits of this function is the feasibility to assign authorization for access and modification of parameters in individual steps of the "User mode". This setting will facilitate the instrument service staff easy operation and prevent unauthorized interference into the setting of vital functions.

CON.LIM Configuration of the access into „Limits“ menu and relay function

CON.AO Configuration of the access into „AO“ menu and selection of the AO type

CON.RS Configuration of the access into „RS“ menu

CON.ER. Configuration of the access into „Brightness“ menu

CON.TAR. Configuration of the access into „Tare“ menu

4.3.2.1.1 SETTING ACCESS INTO THE LIMITS MENU

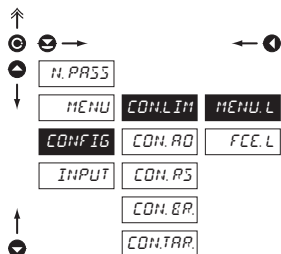

CON.LIM Configuration of the access into „Limits“ menu and relay function

MENU.L Setting the access rights

- selection of the access rights for „User mode“

A - Limit 1, B - Limit 2

Rights	Limits	Hyst.	Time	BA
Prohibited	x	x	x	0
	✓	x	x	1
Projection	✓	✓	x	2
	✓	✓	✓	3
Change of setting	✓	x	x	4
	✓	✓	x	5
	✓	✓	✓	6

4.3.2.1.2 SETTING THE RELAY FUNCTION

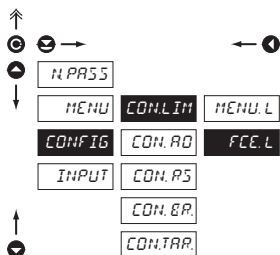
**FCE.L** Relay configuration

A - Limit 1

B - Limit 2

Relay fuunction		BA
Relay	switch-on	0
	switch-off	1

4.3.2.2.1 SETTING ACCESS INTO THE ANALOG OUTPUT MENU

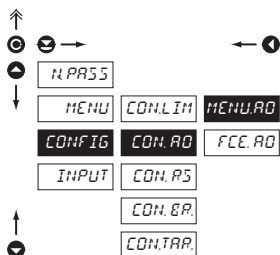
**CON.AO** Configuration of the access into „AO“ menu and selection of the AO type**MENU.AO** Setting the access rights

- selection of the access rights for „User mode“

Rigts	A
Prohibited	0
Projection	1
Change of setting	2

4.3.2.2.2 SETTING THE TYPE OF THE ANALOG OUTPUT

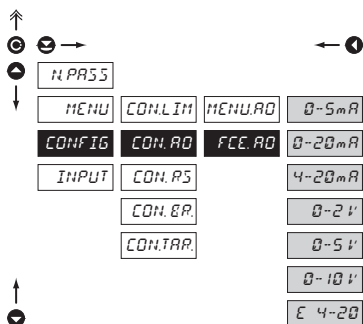
**FCE.AO** Setting the type of the analog output**0-5 mA** Range - 0...5 mA**4-20 mA** Range - 0...20 mA**0-20 mA** Range - 4...20 mA**0-2 V** Range - 0...2 V**0-5 V** Range - 0...5 V**0-10 V** Range - 0...10 V**E 4-20** Range - 4...20 mA with indication „ERROR“

- upon error statement the value on the output is < 3,6 mA

4.3.2.3 SETTING ACCESS INTO THE DATA OUTPUT MENU

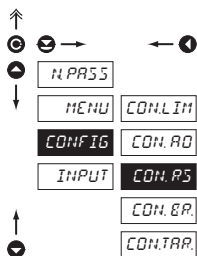
**CON.RS** Setting the access rights

- selection of the access rights for the „User mode“

Rights	A
Prohibited	0
Projection	1
Change of setting	2

4.3.2.4 SETTING ACCESS INTO THE MENU OF BRIGHTNESS SETTING

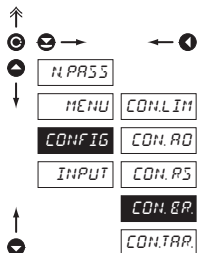
**CON.ER** Configuration of the access into „Brightness“ menu

- selection of access rights for the „User mode“

Rights	A
Prohibited	0
Projection	1
Change of setting	2

4.3.2.5 SETTING ACCESS INTO THE MENU OF TARE RESETTING

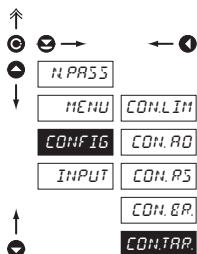
**CON.TAR** Configuration of the access into tare resetting

- selection of access rights for the „User mode“

Rights	A
Prohibited, the function is off	0
Projection	1
Resetting to zero permitted	2

4.3.3 CONFIGURATION MODE - INPUT

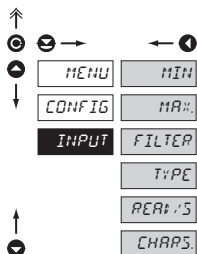

INPUT Setting the input parameters

MIN	Setting display projection for minimum value of the input signal ①
MAX	Setting display projection for maximum value of the input signal ②
FILTER	Setting the digital filter ③
OFFSET	Shift of the beginning of the measuring range ④
LEAD	Compensation of 2-wire conduct ⑤
TYPE	Setting the instrument meas. range and connection ⑥
CONN.	Setting the type of input connection ⑦
RANG	Setting the instrument measuring rate ⑧
CHAR	Setting the projection of measuring units ⑨
CJC	Setting the temperature of the cold junction ⑩
COMP	Method of measurement of the cold junction ⑪

Input type	Setting options
DC	① ② ③ ⑥ ⑧ ⑨
PM	① ② ③ ⑥ ⑧ ⑨
DU	① ② ③ ⑧ ⑨
OHM	① ② ③ ⑤ ⑧ ⑨
RTD	③ ④ ⑤ ⑥ ⑦ ⑧
T/C	③ ⑥ ⑧ ⑩ ⑪

4.3.3.1 PROJECTION ON THE DISPLAY

DC PM DU OHM

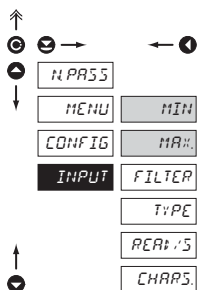

MIN. Setting display projection for minimum value of the input signal

- range of the setting is -999...3999
- positioning of the decimal point in this item is determining for the entire instrument

MAX. Setting display projection for maximum value of the input signal

- range of the setting is -999...3999

! Setting of the decimal point in the MIN item is determining for the entire instrument

SETTING FOR LINEAR POTENTIOMETER

DU

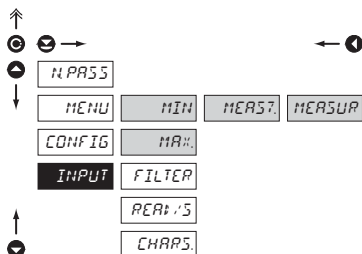

MEAS? Call to place the potentiometer traveller into initial position

- in the MIN and MAX items enter the required projection and confirm by pressing „Enter“
- before confirming the sign „MEAS?“ by „Enter“ the potentiometer traveller has to be positioned and stabilized at the beginning of the measuring range
- the „MEASUR“ sign indicates automatic calibration of the measuring range, the potentiometer traveller has to be at rest

! Calibration for second position is identical with setting of the beginning

4.3.3.2 SHIFTING THE BEGINNING OF THE RANGE

RTD

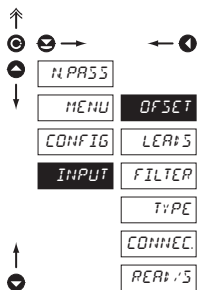

OFFSET Shifting the beginning of the range

- in cases when it is necessary to shift the beginning of the range by certain value, e.g. when sensor is used in a measuring head
- entered directly in Ohm

4.3.3.3 COMPENSATION OF 2-WIRE CONDUCT

OHM RTD

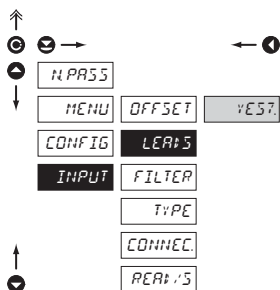

LEAFS Compensation of 2-wire conduct

- for measurement accuracy it is necessary to perform compensation of the conduct always in case of 2-wire connection
- entered directly in Ohm
- prior to confirmation of the displayed challenge „YES?“ it is necessary to substitute the sensor at the end of the conduct by a short circuit
- preset from manufacture to „0“

! The items are visible at all times but the active only upon set 2-wire connection

4.3.3.4 SETTING THE TYPE OF CONNECTION

RTD

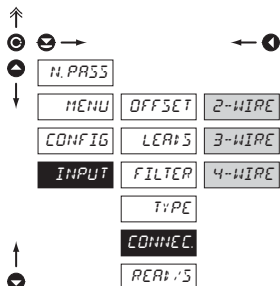

TYPE Setting the type of connection

2-WIRE 2-wire input connection

3-WIRE 3-wire input connection

4-WIRE 4-wire input connection

4.3.3.5 SETTING THE COLD JUNCTION

T/C

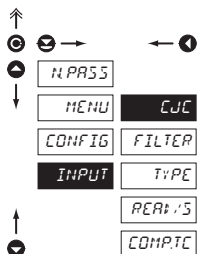

CJC Setting the temperature of the cold junction

- range of 0...98 °C with compensation box
- 99 °C without compensation box, with/without reference thermocouple, temperature of the cold junction is measured at the input brackets of the instrument

☀ Method and procedure of the setting of the cold junctions are described in a separate chapter on page 30

4.3.3.6 SETTING THE METHOD OF MEASUREMENT OF THE COLD JUNCTION

T/C

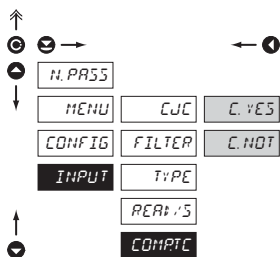
**COMPTC** Setting the method of measurement of the cold junction

- measurement with/without reference thermocouple

C.YES Measurement with reference thermocouple (antiserially)

C.NOT Measurement without reference thermocouple

Method and procedure of setting of the cold junctions are described in a separate chapter on page 30

4.3.3.7 DIGITAL FILTER

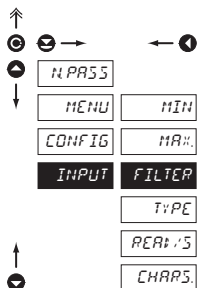
**FILTER** Setting the digital filter

- use of the digital filter will find its place in applications where the change of projection on the display (by given value) interferes or is not substantial in the measuring regime
- it is entered directly in digits and is valid symmetrically

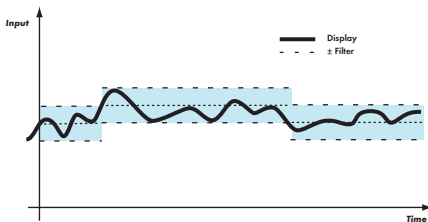

4.3.3.8 SETTING THE MEASURING RANGE

DC PM RTD OHM T/C

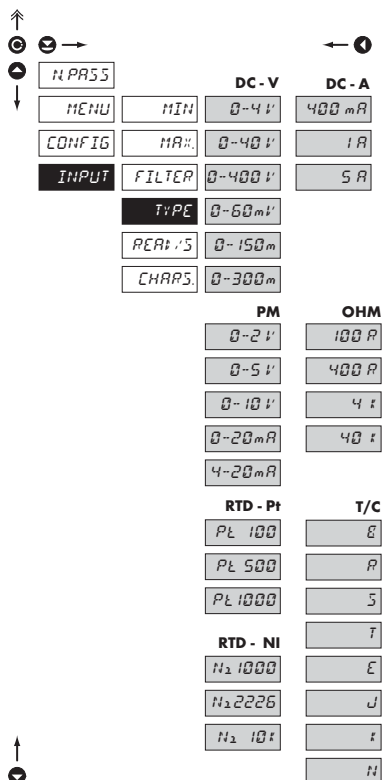

TYPE Setting the measuring range of the instrument

DC Input

- ammeter and voltmeter are two independent instruments

PM Input

- setting the measuring range

RTD Input

- setting the type of sensor
- Pt 3850 ppm/°C EU, standard
- Pt 3920 ppm/°C US, upon request
- Ni 5000 ppm/°C standard
- Ni 6180 ppm/°C upon request

OHM Input

- setting the measuring range
- 100 R 5...105 Ohm
- (100 K request 0...100 kOhm), upon request
- 400 R 0...400 Ohm
- 4 K 0...4 kOhm
- 40 K 0...40 kOhm

T/C Input

- setting the type of thermocouple
- B type B
- R type R
- S type S
- T type T
- E type E
- J type J
- K type K
- N type N

! Upon a change of the range check also the necessary jumper settings (page 28) and connection of given input (page 7)

4.3.3.9 SETTING THE MEASURING RATE

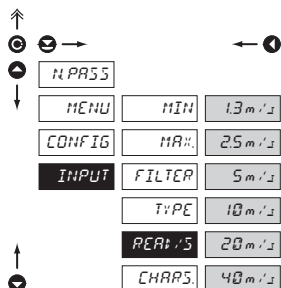
**REAR: S** Setting the measuring rate

- setting the measuring rate is associated with the rate of response to evaluation of the relay status and analog output

1.3 m/s	Rate - 1,3 measurements/s
2.5 m/s	Rate - 2,5 measurements/s
5 m/s	Rate - 5 measurements/s
10 m/s	Rate - 10 measurements/s
20 m/s	Rate - 20 measurements/s
40 m/s	Rate - 40 measurements/s

4.3.3.10 SETTING THE DESCRIPTION OF MEASURING UNITS

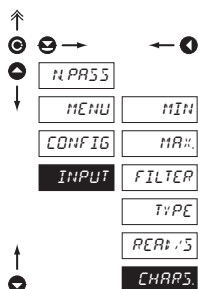
DC PM DU OHM**CHARS.** Setting projection of measuring units on the display

- the instrument allows to add two descriptive characters to the classic numeric formats (at the expense of the number of displayed places). The setting is performed by means of a shifted ASCII code. Upon setting the first two places display the entered characters and the last two places the code of the relevant symbol from 0 to 95.



Description is cancelled by entering characters 00

- instruments with the input for temperature measurement display as a standard °C



 Table of symbols is on page 29

5. CONFIGURATION INPUT

Jumpers are accessible after the instrument is opened

		INPUT "2" (DC)	60 mV	150 mV	300 mV
 J7	Not	X	✓	✓	✓
	Yes	✓	X	X	X
 J8	Not	X	X	X	X
	Yes	X	X	X	X

		INPUT "2", "U"	DC	PM
 J9	5 - 6	0...4 V	0...2 V	
	3 - 4	0...40 V	0...5 V	
	1 - 2	0...400 V	0...10 V	

		INPUT (T/C)	E, J, K, N	T, R, S	B
 J7	Not	✓	✓	X	
	Yes	X	X	✓	✓
 J8	Not	✓	X	X	
	Yes	X	✓	✓	✓

		INPUT	RTD
 J4	5 - 6	Pt 100/Ni 1 000	
	3 - 4	Pt 500/Ni 2 226	
	1 - 2	Pt 1 000/Ni 10 000	

		INPUT	OHM - Input 1
 J5	5 - 6	0...400 Ohm	
	3 - 4	0...4 kOhm	
	1 - 2	0...40 kOhm	

		FUNKTIONEN	Hold	Lock
 J1	Not	✓	✓	X
	Yes	X	X	✓

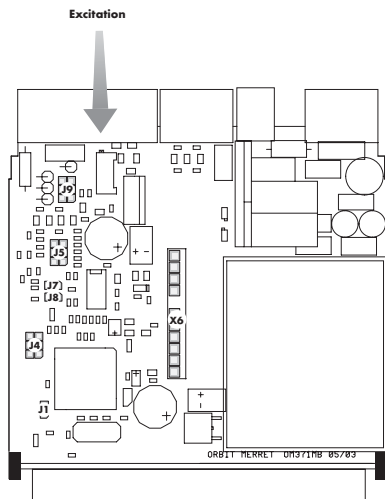

! For every jumper setting disconnect the instrument from the mains

6. TABLE OF SYMBOLS

The instrument allows to add two descriptive characters to the classic numeric formats (at the expense of the number of displayed places). The setting is performed by means of a shifted ASCII code. Upon modification the first two places display the entered characters and the last two places the code of the relevant symbol from 0 to 95. Numeric value of given character equals the sum of the numbers on both axes of the table.

Description is cancelled by entering characters with code 00

	0	1	2	3	4	5	6	7		0	1	2	3	4	5	6	7
0		Q	"	#	\$	%	&	'	0	!	"	#	\$	%	&	'	
8	()	*	+	,	-	.	/	8	()	*	+	,	-	.	/
16	0	1	2	3	4	5	6	7	16	0	1	2	3	4	5	6	7
24	8	9	:	;	<	=	>	?	24	8	9	:	;	<	=	>	?
32	A	B	C	D	E	F	G		32	@	A	B	C	D	E	F	G
40	H	I	J	K	L	M	N	O	40	H	I	J	K	L	M	N	O
48	P	Q	R	S	T	U	V	W	48	P	Q	R	S	T	U	V	W
56	X	Y	Z	[\]	^	_	56	X	Y	Z	[\]	^	_
64	`	a	b	c	d	e	f	g	64	`	a	b	c	d	e	f	g
72	h	i	j	k	l	m	n	o	72	h	i	j	k	l	m	n	o
80	p	q	r	s	t	u	v	w	80	p	q	r	s	t	u	v	w
88	x	y	z	{		}	~		88	x	y	z	{		}	~	

7. METHOD OF MEAS. OF THE COLD JUNCTION

An instrument with input for temperature measurement with thermocouple allows for setting of two types of measurement of the cold junction.

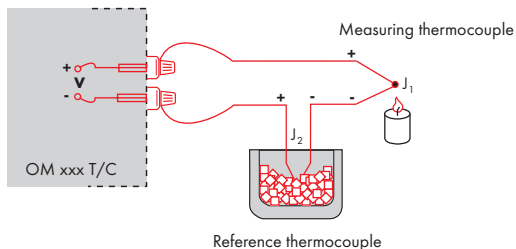

WITH REFERENCE THERMOCOUPLE

- a reference thermocouple may be located in the same place as the measuring instrument or in place with stable temperature/compensation box
- when measuring with reference thermocouple set *COMPTEC* in the instrument menu to *CE5*
- when using a thermostat (a compensation box or environment with constant temperature) set *CCC* in the instrument menu to its temperature
- if the reference thermocouple is located in the same environment as the measuring instrument then set *CCC* in the instrument menu to number 99. Based on this selection the measurement of the surrounding temperature is performed by a sensor located in the instrument terminal board.

WITHOUT REFERENCE THERMOCOUPLE

- inaccuracy originating from the creation of dissimilar thermocouples on the transition point terminal-conductor of the thermocouple is not compensated for in the instrument
- when measuring without reference thermocouple set *COMPTEC* in the instrument menu to *CNOT*
- when measuring temperature without reference thermocouple the error in measured data maybe even 10 °C

8. DATA PROTOCOL

The instruments communicate via serial line RS232 or RS485. For communication they use the ASCII protocol. The communication is running in the following format:

ASCII: 8 bit, no parity, one stop bit

Transmission rate is adjustable in the instrument menu and depends on the used control processor. The instrument address is set in the instrument menu in the range of 0...31. Manufacture setting always presets the ASCII protocol, rate of 9600 Baud, address 00. Type of line used - RS232 / RS485 - is determined by exchangeable card automatically identified by the instrument.

COMMANDS FOR INSTRUMENT OPERATION

The commands are described in the description which can be found at www.orbit.merret.cz/rs.

The command consists of a couple number-letter, where the letter size is of importance.

Symbol	Meaning	Symbol	Meaning
⊕	Send unit value	Ⓒ	Complete number
⊕	Set unit value	⒱	Selection = complete number
■	Perform relevant action	Ⓓ	Decimal number
		Ⓓ	Text - printable ASCII characters
		Ⓗ	Intel HEX format

DETAIL DESCRIPTION OF COMMUNICATION VIA SERIAL LINE

Activity	Type	Protocol	Data transferred															
Data solicitation (PC)	232	ASCII	#	A	A	<CR>												
	485	ASCII	#	A	A	<CR>												
Data transfer (Instrument)	232	ASCII	>	D	D	D	D	D	D	D	(D)	(D)	(D)	(D)	<CR>			
	485	ASCII	>	D	D	D	D	D	D	D	(D)	(D)	(D)	(D)	<CR>			
Command transfer (Instrument)	232	ASCII	#	A	A	N	P	D	D	D	D	(D)	(D)	(D)	<CR>			
	485	ASCII	#	A	A	N	P	D	D	D	D	(D)	(D)	(D)	<CR>			
Command confirmation (Instrument)	232	ASCII	ok	!	A	A	<CR>											
			bad	?	A	A	<CR>											
	485	ASCII	ok	!	A	A	<CR>											
			bad	?	A	A	<CR>											

Legend			
#	35	23 _H	Beginning of the command
A	A	0...31	Two signs of the inst. address (sent in ASCII - decades and units, ex."01")
<CR>	13	0D _H	Carriage return
<SP>	32	20 _H	Space
N	P		Number and command - command code
D			Data - usually signs "0"... "9", "-", ".", " "; (D) - dp. and (-) may prolong data
R		30 _H ...3F _H	Relay status; zero bit corresponds with 1st relay, 1st bit with 2nd relay, etc.
!	33	21 _H	Positive command confirmation (ok)
?	63	3F _H	Negative command confirmation (bad)
>	62	3E _H	Beginning of the transmitted data

9. ERROR STATEMENTS

ERROR	REASON	ELIMINATION
<i>E.UND.</i>	range underflow (A/D converter)	change the input signal value or change display projection
<i>E.OVER.</i>	range overflow (A/D converter)	change the input signal value or change display projection
<i>E.Mat</i>	mathematic error, range of projection is out of display	change the set projection
<i>E.Dat.a.E</i>	violation of data integrity in EEPROM, error upon data storage	in case of recurring report send the instrument for repair
<i>E.Mem.</i>	EEPROM error	the „Def“ values will be used in emergency, instrument needs to be sent for repair
<i>E.CALIB</i>	calibration error, loss of calibration data	instrument needs to be sent for repair

10. INSTRUMENT DIMENSIONS AND INSTAL.

Front view



Panel cut

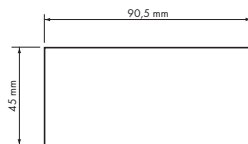

Side view

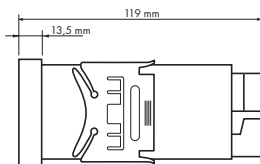

Panel thickness: 0,5...20 mm

Instrument installation

1. insert the instrument into the panel cut-out
2. fit both travellers on the box
3. press the travellers close to the panel

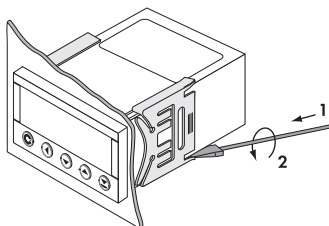
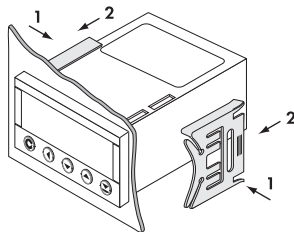

Instrument disassembly

1. slide a screw driver under the traveller wing
2. turn the screw driver and remove the traveller
3. take the instrument out of the panel

11. TECHNICAL DATA

INPUT

selectable in configuration menu

0...4 V	1 MOhm	DC	Input 2
0...40 V	1 MOhm		Input 2
0...400 V	1 MOhm		Input 2
0...60 mV	1 MOhm		Input 1
0...150 mV	1 MOhm		Input 1
0...300 mV	1 MOhm		Input 1

0...400 mA	< 60 mV		Input 2
0...1 A	< 60 mV		Input 1
0...5 A	< 60 mV		Input 1

selectable in configuration menu

0/4...20 mA	< 400 mV	PM	Input I
0...2 V	1 MOhm		Input U
0...5 V	1 MOhm		Input U
0...10 V	1 MOhm		Input U

selectable in configuration menu

0...400 Ohm		OHM	Input 1
0...4 Ohm			Input 1
0...40 kOhm			Input 1
5...105 Ohm			Input 2
0...100,0 kOhm	(upon request)		Input 2

Connection:

2 wire

Pt xxxx

-99,9°...399,9°C

Ni xxxx

-30,0°...250,0°C

Type Pt:

100/500/1 000 Ohm, platinum couple
s $\alpha = 0,003850 \text{ Ohm/Ohm/}^\circ\text{C}$

Type Ni:

Ni 1 000/2 226/10 000, 5000 ppm/6180 ppm

Connection:

2, 3 or 4 wire

selectable in configuration menu

Type:	J (Fe-CuNi)	0°...900°C	T/C
	K (NiCr-Ni)	0°...1 300°C	
	T (Cu-CuNi)	0°...400°C	
	E (NiCr-CuNi)	0°...690°C	
	B (PtRh30-PtRh6)	300°...1 820°C	
	S (PtRh10-Pt)	0°...1 760°C	
	R (Pt13Rh-Pt)	0°...1 740°C	
	N (OmegaGalloy)	0°...1 300°C	

- The instrument evaluates only temperatures higher than the temperature of the cold junction (C J)

DU

Lin. pot. supply

2,5 VDC/6 mA

min. potentiometer resistance is 500 Ohm

PROJECTION

Display: 999999, intensive red or green 14-ti segment LED, digit height 14 mm

Projection: -999...3999

Decimal point: adjustable - in programming mode

BRIGHT.: adjustable - in programming mode

INSTRUMENT ACCURACY

Temperature coef.: 100 ppm/°C

Accuracy: $\pm 0,15\%$ of the range DC/PM/DU $\pm 0,25\%$ of the range (for 60/150/300 mV) DC $\pm 0,5\%$ of the range A C $\pm 0,2\%$ of the range OHM/RTD/TCResolution: 0,1° RTD1°C T/C

Rate: 1,3 - 2,5 - 5 - 10 - 20 - 40 measurements/s

Overload capacity: 10x ($t < 100$ ms), 2x (long-term)

Digital filter: adjustable in configuration menu

Comp. of conduct: max. 40 Ohm RTDComp. of cold junct.: adjustable T/C

0°...98°C or automatic (99)

Functions: Tare - display resetting

Hold - stop measuring (upon contact)

Projection of measured units

Watch-dog: reset after 1,2 s

Calibration: at 25°C and 40% r.h.

COMPARATOR

Type: digital, adjustable in the menu

Limits: -999...3999

Hysteresis: 0...999

Delay: 0...99,9 s

Outputs: 2x relays with switch-on contact

(230 VAC/30 VDC, 3 A)*

Relay: 1/8 HP 277 VAC, 1/10 HP 125 V, Pilot Duty D300

DATA OUTPUTS

Protocols: ASCII

Data format: 8 bit + no parity + 1 stop bit (ASCII)

Rate: 150...115 200 Baud

RS 232: isolated, two-way communication

RS 485: isolated, two-way communication,

addressing (max. 31 instruments)

ANALOG OUTPUTS

Type:	isolated, programmable with resolution of max. 10 000 points, analog output corresponds with the displayed data, type and range are adjustable
Non-linearity:	0,2% of the range
TC:	100 ppm/°C
Rate:	response to change of value < 100 ms
Voltage:	0...2 V/5 V/10 V
Current:	0...5/20 mA/4...20 mA - compensation of conduct up to 600 Ohm

EXCITATION**PM**

Adjustable: 2...24 VDC/50 mA, isolated

POWER SUPPLY

Options:	24/110/230 VAC, 50/60 Hz, ±10%, 5 VA 10...30 VDC/max. 300 mA, isolated
Protection:	by a fuse inside the instrument VAC (T 80 mA), VDC (T 630 mA)

MECHANIC PROPERTIES

Material:	Noryl GFN2 SE1, incombustible UL 94 V-I
Dimensions:	96 x 48 x 120 mm
Panel cut-out:	90,5 x 45 mm

OPERATING CONDITIONS

Connection:	connector terminal board, conductor section up to 2,5 mm ²
Stabilisation period:	within 15 minutes after switch-on
Working temp.:	0°...60°C
Storage temp.:	-10°...85°C
Cover:	IP65 (front panel only)
Construction:	safety class I
Overvoltage cat.:	EN 61010-1, A2 III. - instrument power supply (300 V) II. - input, output, excitation (300 V) for pollution degree II
EMC:	EN 61000-3-2+A12; EN 61000-4-2, 3, 4, 5, 8, 11; EN 550222, A1, A2

12. DECLARATION OF CONFORMITY

Company: ORBIT MERRET, spol.s r.o. (Ltd.)
 Klánova 81/141
 142 00 Prague 4
 Czech Republic
 IDNo: 00551309

Manufactured: ORBIT MERRET, spol.s r.o. (Ltd.)
 Vodňanská 675/30
 198 00 Prague 9
 Czech Republic

declares at its full responsibility that the product presented hereunder meets all technical requirements, is safe for use when utilised under the terms and conditions determined by ORBIT MERRET, spol.s r.o. and that our company has taken all measures to ensure conformity of all products of the type listed hereunder, which are being brought out to the market, with technical documentation and requirements of the appurtenant statutory orders.

Product: 3 3/4 -digit programmable panel instrument

Type: OM 371, in versions: DC, PM, DU, PWR, OHM, RTD, T/C

Mode of asses. of conformity: §12, par. 4 b, d of Act No.22/1997 Sb.

Conformity is assessed pursuant to the following standards:

Electrical safety: EN 61010-1
 EMC: EN 50131-1, par. 14 and par. 15
 EN 55022
 EN 61000-3-2 + A12, Cor. 1, change A1, change A2
 EN 61000-4-2
 EN 61000-4-3
 EN 61000-4-4
 EN 61000-4-5
 EN 61000-4-6
 EN 61000-4-8
 EN 61000-4-11

and government ordinance:

Electrical safety: No. 168/1997 Sb.
 EMC: No. 169/1997 Sb.

The evidence are the protocols of authorized and accredited organization:

VTÚE Praha, experimental laboratory No. 1158 accredited by ČIA, o.p.s. with EN ISO/IEC 17025

Place and date of issue: Prague, 21. november 2001

Miroslav Hackl
 Company representative

13. CERTIFICATE OF GUARANTEE

Product **OM 371 DC PM DU RTD T/C OHM**

Type

Manufacturing No.

Date of sale

GUARANTEE

A guarantee period of 24 months from the date of sale to the user applies to this instrument.

Defects occurring during this period due to manufacture error or due to material faults shall be eliminated free of charge.

For instrument quality, function and construction the guarantee shall apply provided that the instrument was connected and used in compliance with the instruction for use.

The guarantee shall not apply for defects caused by:

- mechanic damage
- in transport
- intervention of unqualified person incl. the user
- unavoidable event
- other unprofessional interventions

The manufacturer performs the guarantee and post-guarantee repairs unless provided for otherwise.

Stamp, signature

Y E R S

ORBIT MERRET, spol. s r.o.

Vodnanska 675/30
198 00 Prague 9
Czech Republic
tel: +420 - 281 040 200
fax: +420 - 281 040 299
e-mail: orbit@merret.cz
www.orbit.merret.cz

Austria

ING.E.GRUBER GmbH
Edu. Kittenberger Gasse 97 Top2
A-1230 Wien
tel: +43 - 1 - 869 23 39-0
fax: +43 - 1 - 865 18 75
e-mail: office@gruber-components.at
www.gruber-components.at

The Netherlands

AE SENSORS B.V.
J. Valsterweg 92
3301 AB Dordrecht
tel: +31 - 78 - 621 31 52
fax: +31 - 78 - 621 31 46
e-mail: aesensors@aesensors.nl
www.aesensors.nl

Switzerland

ORBIT CONTROLS AG
Zürcherstrasse 137
8952 Schlieren
tel: +41 - 1 - 730 27 53
fax: +41 - 1 - 730 27 83
e-mail: info@orbitcontrols.ch
www.orbitcontrols.ch

USA

METRIX Instruments Co.
1711 Townhurst Dr.
Houston, Texas 77043-2899
tel: +1 - 713 - 461 21 31
fax: +1 - 713 - 461 82 83
e-mail: sales@metrix1.com
www.metrix1.com

Germany

MEGATRON Elektronik AG & Co.
Hermann-Oberth-Str. 7
85640 Putzbrunn/München
tel: +49 - 89 - 460 94 - 0
fax: +49 - 89 - 460 91 01
e-mail: sales@megatron.de
www.megatron.de

Russian Federation

PO <INTERFACE>
a.b. 3408
Krasnodar, 350044
tel: +1 - 8612 - 660 483
fax: +1 - 8612 - 623 000
e-mail: iff@au.ru
www.meter.chat.ru

Turkey

ALFA ELEKTRONIK Ltd.
Baglarbasi Mah. Ergenekon No: 33
TR - 81540 Maltepe - ISTANBUL
tel: +90 - 216 - 442 39 49
fax: +90 - 219 - 305 54 50
e-mail: sb@elmak.com.tr
www.alfa-technik.com

Lithuania

RIFAS UAB
Tinklu g. 29a
LT-5300 Panevėžys
tel: +370 - 5 - 510 400
fax: +370 - 5 - 582 729
e-mail: sales@metrix1.com
www.metrix1.com

Slovakia

TECHREG, s.r.o.
Dukelských hrdinov 2
984 22 Lučenec
tel: +421 - 47 - 433 15 92
fax: +421 - 47 - 433 15 92
e-mail: techreg@bb.psg.sk
www.techreg.sk

Ukraine

OOO <KOTRIS>
Nesterova 3, Office 907
030 57 Kyjev
tel: +44 - 446 - 21 42
fax: +44 - 446 - 21 42
e-mail: metrix-ua@svitonline.com