

CATALOGUE OF INSTRUMENTS CERTIFIED FOR USE IN NUCLEAR POWER PLANTS

MEASURING INSTRUMENTS
BARGRAPHS
TRANSMITTERS TO DIN RAIL





GENERAL BUSINESS TERMS



1. Basic provisions

- The General business, service and guarantee terms arrange the relations for the delivery of goods and services, hereinafter referred to as "the Subject of performance" by ORBIT MERRET, spol. s r.o., (hereinafter referred to as "the Supplier") to Customers and are binding upon all and any business relations.
- By signing the legally binding acts leading to the establishment of a Supplier-customer relationship of obligatory character, related to the delivery of the Subject of performance by the Supplier, the parties accept that their mutually binding relationship shall be governed in terms of the provisions of Section 262, par. 1 of the Commercial code by regime of the quoted law. Establishment of the arranged binding relationship is always conditioned by the Supplier's acceptance of the Customer's order form.

2. Price of the Subject of performance

- Catalogues and pricelists issued by the Supplier as well as oral and telephone information about the price of the Subject of performance are of informative character, not binding for the Supplier and not claimable by the Customer. The Supplier reserves the right to modify technical parameters, or as the case may be, also the prices of the Subject of performance without prior written notice. The Supplier is not responsible for errors generated during the print of the business and technical materials.
- For specification of the price, the Customer is entitled to request a binding quotation (hereinafter referred to as "the Quotation"), which is valid for a period of 21 calendar days from the date of issue unless provided otherwise.
- Prices of the Subject of performance listed in the Quotation do not include any related services, unless expressly provided for otherwise. Requirement for the provision of related services needs to be stated in the order.
- The Supplier assumes a standard use of the Subject of performance. Any specific requirements for the Subject of performance need to be expressed in the order.

3. Concluding the contract

- Individual business deals are concluded on the basis of written orders from the Customer, sent either by mail or fax, exceptionally also on the basis of oral or telephone order.
- An order has to contain the following elementary properties:
 - business name and seat of the Customer including telephone and facsimile contact numbers
 - name of the person authorized to act on behalf of the Customer, Trade Licence No. and Tax identification No. (if the Customer is registered as VAT payer),
 - explicit specification of the Subject of performance as per technical background materials of ORBIT MERRET, spol. s r.o., quantity, delivery terms (place and deadline),
 - if pertinent, further specific requirements for the Subject of performance.
- After the receipt of Customer Order the Supplier sends the Customer an "Order Confirmation", which is done in writing either by fax or via e-mail. The Supplier is entitled to accept also orders delivered to him after the term of validity of the quotation expired. The Supplier is obligated to send the Order confirmation to the Customer no later than within 3 business days of the date of delivery of the order.
- In case the Customer Order requires a non-standard Subject of performance or the amount exceeds 1000 \$, prior to accepting the order, the Supplier may solicit a deposit in the amount agreed-upon in virtue of issued pro-forma invoice. The delivery time stated in the Order Confirmation starts running on the date the Customer pays the deposit.
- In case of larger supplies of the Subject of performance or specific conditions under which the supply is to be realized, or if either of the parties requires so, the parties of the contract may enter into a special agreement on the Subject of performance with reference to the wording of these General terms.
- All additional modifications or amendments to the contract (order) have to be made in writing in order to take effect.

4. Delivery terms

- Supplies of the Subject of performance shall be realized according to the Supplier's capacity in the shortest possible term, usually within 2 – 21 days, in case of special products and more extensive supplies within 3 – 8 weeks.
- The Supplier will meet the delivery terms provided that all financial obligations of the Customer from previously realized business deals have been settled.
- The expected term of supply is stated in the Order confirmation. In singular cases the Supplier may prolong the term of supply, however, he shall notify the Customer about the fact without undue delay.
- Delays in delivery terms of our subcontractors, strikes, export or import embargos, war or other

- events of force majeure relieve the Supplier from the obligation to deliver in term, without the Customer having the right to cancel the order or the right to claim damages (penalty).
- The delivery term is considered fulfilled when the Subject of performance is delivered to the Customer in the issuing office of the Supplier (personal collection), or by appointed employee of the Supplier in the place of delivery or by handover of the Subject of performance to the first domestic carrier.
- If personal collection by the Customer is arranged for, the delivery term is considered fulfilled also by notification of the Customer, that the Subject of performance is ready for dispatch.
- Costs related to delivery and place of performance other than the issuance office of the Supplier shall be borne by the Customer.
- If the Customer fails to take over the Subject of performance due to reasons on his part, the Customer shall bear the full costs related to repeated delivery.
- If the Customer finds variance with the delivery note, difference in quantity and type of performance, apparent damage of packaging or products, he is obligated to immediately report such fact to the Supplier or the bearer of the consignment, and record it in writing on the delivery note or the delivery note of the forwarding service, however, within 2 business days from delivery at the latest. Later claims of this character will not be taken into account.

5. Orders cancelled by the Customer

- In case of order cancelled after it has been confirmed based on request of the Customer, the Supplier is entitled to bill the Customer 20 % of the price of not taken products.
- If the delivered Subject of performance is returned without justification after the agreed-upon term, the Supplier is entitled to charge a contractual penalty in the amount of 50% of the total price of the delivery.
- If the Supplier enforces his right to compensation money or contractual penalty for unjustified return of delivery pursuant to the provisions of par. 5.2., confirmation of the order is cancelled after the set amount is paid. In case of default in payment of this amount the Supplier is entitled to enforce the sanctions pursuant to par. 6.3.

6. Terms of payment

- Unless special terms of payment were arranged for, our invoices are due for payment within 14 days.
- The Supplier is entitled to invoice immediately after the Subject of performance is handed over to the first public carrier, in case of personal collection after it is realized or after delivery of goods by the Supplier.
- If the Customer fails to pay in due date, he is obligated to pay the Supplier a contractual penalty for delay in the amount of 0,10 % of the billed amount for each day of delay.
- In case of delay in performance of the Customer's liabilities the Supplier is not obligated to perform further supplies until the debt is liquidated. In such case, the Customer is not entitled to claim penalty for late performance that ensued from given circumstances. In case of long-term default in performance of liabilities of the Customer, his confirmed orders may be excluded from the records without any compensation.
- The due date is the date by which the amount has to be credited to the account of the Supplier or paid in cash at the Supplier's cash desk.

7. Ownership of the subject of performance

- The right of ownership to the Subject of performance pursuant to these General terms is transferred to the Customer at the moment of payment of the full amount of the purchase price.

8. Guarantee terms

- The Supplier provides a 60 months guarantee for non-defective operation of the Subject of performance, which period starts running on the date of its delivery unless provided for otherwise.
- The Supplier is not responsible for damages caused by incorrect warehousing, wrong outer connexion, outside influences, in particular electric quantities of inadmissible magnitude, unprofessional assembly, wrong adjustment or attendance.

9. Other provisions

- In cases when the General business terms differ from the terms set out in the submitted Customer order, the provisions contained in the order confirmation hold valid for the purpose of conclusion of the contract. Prospective modifications from the Customer have to be approved by the Supplier, otherwise par. 3.6. applies.
- The mode of transportation of the Subject of performance is determined by the Supplier with maximum respect to economical aspects of the transport, unless the Customer has expressly requested otherwise.
- The General business terms are governed by the provisions of the Commercial code. Any disputes related to the application, implementation or interpretation hereof would be solved at the Commercial court in Prague.

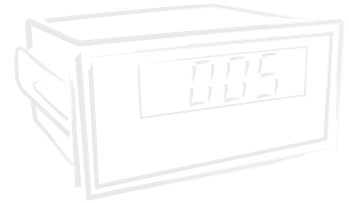
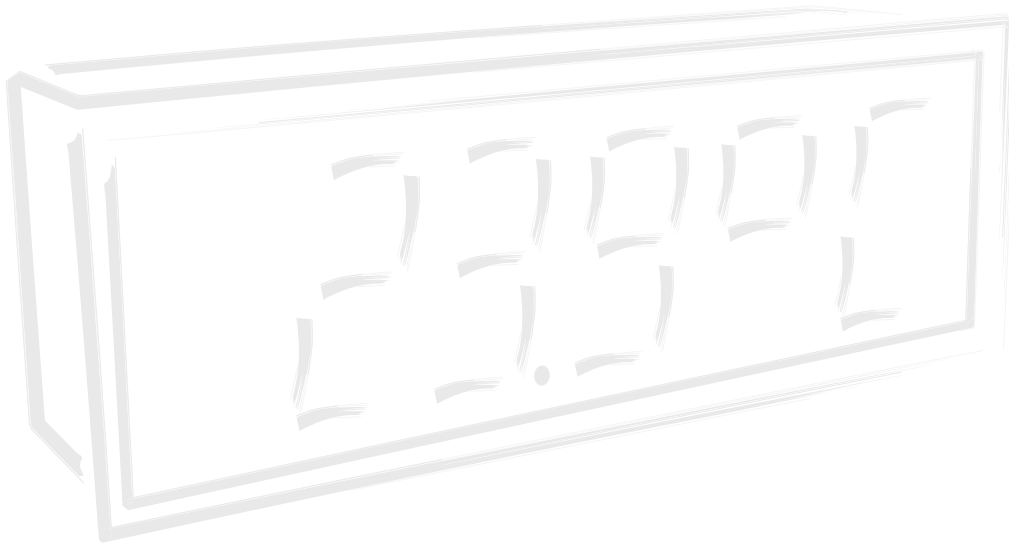

PANEL MEASURING



INSTRUMENTS

FOR NUCLEAR POWER



PLANTS

2017.1

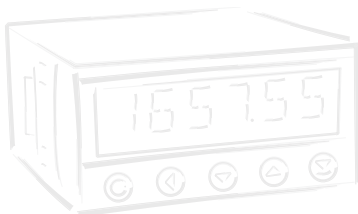
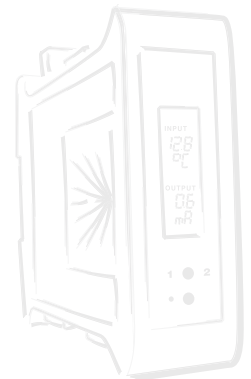
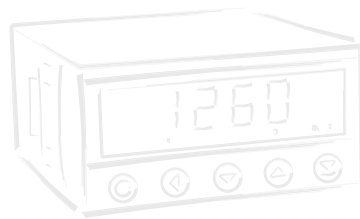

INSTRUMENTS - OVERVIEW



	Type	Protection	Height (mm)	Input	Rate (measurements/s)	Accuracy (% of range)	Limits	Analog	Data	AV or Data	Excitation	Digital filters	Functions	RTC	OM Link	Power supply	Dimensions (mm)	Page
DC VA-meters	OM 402UNI	±9999	14	±60 mV...±500 V ±0,1 A...±5 A	0,1...40	±0,1	○○○○	○	○	×	●	●	Tare, Hold, Lock, MF, Min/Max, Peak value, Linearization in 50 points	○	●	10...30 V AC/DC 80...250 V AC/DC	96 x 48	6
Process monitors	OM 402UNI	±9999	14	1..4 inputs ±2 V/±5 V/±10 V/±40 V ±5 mA/±20 mA/4...20 mA	0,1...40	±0,1	○○○○	○	○	×	●	●	Tare, Hold, Lock, MF, Min/Max, Peak value, Mat. operations between inputs, Linearization in 50 points	○	●	10...30 V AC/DC 80...250 V AC/DC	96 x 48	6
Ohmmeters	OM 402UNI	9999	14	0,1/1/10/100 kΩ/Auto	0,1...40	±0,1	○○○○	○	○	×	●	●	Tare, Hold, Lock, MF, Min/Max, Peak value, Linearization in 50 points	○	●	10...30 V AC/DC 80...250 V AC/DC	96 x 48	6
Wattmeters AC VA-meters	OM 402PWR	9999	14	0...10/20/250/450 V 0...60/150/300 mV, 1/2,5/5 A	0,6...5	±0,2	○○○○	○	○	×	×	●	V _{RMS} , A _{RMS} , W, Hz, Q, S, cos φ, Hold, Lock, Min/Max	○	●	10...30 V AC/DC 80...250 V AC/DC	96 x 48	6
Linearization instruments	OM 402UNI	±9999	14	±2 V; ±5 V; ±10 V; ±40 V ±5 mA; ±20 mA; 4...20 mA	0,2...40	±0,1	○○○○	○	●	×	●	●	Tare, Hold, Lock, MF, Min/Max, Peak value, Linearization in 50 points	○	●	10...30 V AC/DC 80...250 V AC/DC	96 x 48	6
Thermometers	OM 402UNI	±9999	14	Pt 50/100/500/1000, Ni 1000/10000, Cu 50/100 J/K/T/E/B/S/R/N/L	0,1...40	±0,15	○○○○	○	○	×	●	●	Hold, Lock, Tare Aut. compensation CJC MF, Min/Max, Peak value	○	●	10...30 V AC/DC 80...250 V AC/DC	96 x 48	6
Displays for linear potentiomet.	OM 402UNI	±9999	14	Lin. potentiometer > 500 Ω	0,1...40	±0,2	○○○○	○	○	×	●	●	Tare, Hold, Lock, MF, Min/Max, Peak value, Linearization in 50 points	○	●	10...30 V AC/DC 80...250 V AC/DC	96 x 48	18
Programmable AD	OM 602AV	999999	14	Auxiliary inputs (UP/DW)		±0,2	○○○○	●	○	×	○	×	sinus/saw/triangle/ rectangle/random function Hold, Lock, MF, Min/Max	×	●	10...30 V AC/DC 80...250 V AC/DC	96 x 48	8
Loggers	OMU 408UNI	±9999	14	4x/8x ±60 mV...40 V ±5/±20/4...20 mA/±2/5/10 V 0...0,1/1/10/100 kΩ Pt 100/500/1 000, Cu 50/100 Ni 1000/10 000 J/K/T/E/B/S/R/N/L Lin. potentiometer > 500 Ω	1,0...40	±0,2	○○○○ ○○○○	×	×	○	×	●	Tare, Hold, Lock, MF, Min/Max, Peak value, Ex. control, Rounding, Mat. operations between inputs, Aut. compensation CJC Linearization in 254 points	○	●	10...30 V AC/DC 80...250 V AC/DC	96 x 48	10
Bargraphs	OMB 402UNI	30 LED + ±9999	9,1	±60 mV...500 V/0...5 A 0...20/4...20 mA/0...2/5/10 V 0...0,1/1/10/100 kΩ Pt 100/500/1 000 Ni 1000/10 000, Cu 50/100 J/K/T/E/B/S/R/N/L Lin. potentiometer > 500 Ω	0,1...40	±0,2	○○○○	○	○	×	●	●	Hold, Lock, Tare Aut. compensation CJC MF, Min/Max, Peak value Linearization in 50 points	○	●	10...30 V AC/DC 80...250 V AC/DC	96 x 48	12
	OMB 451UNI OMB 452UNI	50 LED + 999999 +LCD	9,1 14	±60 mV...500 V/0...5 A 0...20/4...20 mA/0...2/5/10 V 0...0,1/1/10/100 kΩ Pt 100/500/1 000 Ni 1000/10 000, Cu 50/100 J/K/T/E/B/S/R/N/L Lin. potentiometer > 500 Ω	0,1...40	±0,2	○○○○	○	○	×	●	●	Hold, Lock, Tare Aut. compensation CJC MF, Min/Max, Peak value Linearization in 50 points	○	●	10...30 V AC/DC 80...250 V AC/DC	160x60 160x80	14 16
	OMB 481	48 LED		0...60 mV, 0...10 V 0...5/20 mA/4...20 mA, E/J/K/N + GOST-R	0,5/5/50	±0,1	○○	×	×	×	●	●	Hold, Lock Linearization in 25 points	○	●	10...30 V AC/DC	164x30	18
	OMB 483	{3x} 48 LED		0...60 mV, 0...10 V 0...5/20 mA/4...20 mA, E/J/K/N + GOST-R	0,5/5/50	±0,1	○○	×	×	×	●	●	Hold, Lock Linearization in 25 points	○	●	10...30 V AC/DC	164x60	18
	OMB 484	{4x} 48 LED		0...60 mV, 0...10 V 0...5/20 mA/4...20 mA, E/J/K/N + GOST-R	0,5/5/50	±0,1	○○	×	×	×	●	●	Hold, Lock Linearization in 25 points	○	●	10...30 V AC/DC	164x60	18
	OM 402JEDU	32 LED +9999 +999999	14	±60 mV...40 V ±5/±20/4...20 mA/±2/5/10 V 0...0,1/1/10/100 kΩ Pt 100/500/1 000, Cu 50/100 Ni 1000/10 000 J/K/T/E/B/S/R/N/L Lin. potentiometer > 500 Ω	1,0...40	±0,2	●●●●	●	○	×	●	●	Tare, Hold, Lock, MF, Min/Max, Peak value, Rounding, Aut. compensation CJC Linearization in 50 points	●	●	10...30 V AC/DC 80...250 V AC/DC	183x153	20

○ on request

● standard

× cannot be ordered

Type	Projection	Height (mm)	Input	Rate (measurement-1/s)	Accuracy (% of range)	Limits	Analog	Data	AV or Data	Excitation	Digital filters	Functions	RTC	OM Link	Power supply	Dimensions (mm)	Page
OMX 102DC	3+3 LCD + Descr.	3,5	±1/5 A ±25/50/100/200/400 V	0,5...160	±0,15	OO	●	○	×	○	●	Hold/Lock, Tare, Linearization in 50 points	×	●	24/110/230 V AC 10...30 V DC	113x 98	22
OMX 102UNI	3+3 LCD + Descr.	3,5	2x ±30/60/1000 mV ±5/20/90/180 mA, 4...20 mA ±2/5/10/20/40/80 V 0,1/0,3/1/5/3/24/30 kΩ Pt 50/100/500/1 000 Ni 000/10 000, Cu 50/100 J/K/T/E/B/S/R/N/L Lin. potentiometer > 500 Ω	0,5...160	±0,15	OO	●	○	×	○	●	Hold/Lock, Tare, Linearization in 50 points	○	●	10...30 V AC/DC 80...250 V AC/DC	113x 98	22
OMX 102PWR	3+3 LCD + Descr.	3,5	0...1/5 A; 0...60/300 mV 0...10/120/250/450 V	0,6...5	±0,3 ±0,6	OO	●	○	×	○	●	Hold/Lock, Teach-in Linearization in 50 points	○	●	10...30 V AC/DC 80...250 V AC/DC	113x 98	22
OMX 102UQC	3+3 LCD + Descr.	3,5	TTL, PNP/NPN, 0,1 Hz...50 kHz, < 30/300 V	0,1...50 s	±0,01 ±0,05	OO	●	○	×	○	●	Hold/Lock, Teach-in Linearization in 50 points	○	●	10...30 V AC/DC 80...250 V AC/DC	113x 98	22
OMX 102T	3+3 LCD + Descr.	3,5	1...4/2...8/4...16 mV/V	0,5...160	±0,15	OO	●	○	×	○	●	Hold/Lock, Teach-in Linearization in 50 points	○	●	10...30 V AC/DC 80...250 V AC/DC	113x 98	22

Digital transmitters to DIN rail

○ on request

● standard

× cannot be ordered

The program OM Link is designed for easy configuration, operation, firm-ware upgrade of instruments and converters and for visualization of the measuring process. The new ORBIT MERRET instruments include the OM Link interface in their standard features. To connect to PC an OML cable is required (version USB or RS232).

The program may be used for configuration (1 instrument) or data collection via RS 232 and RS 485 line, more suitable for on-line connection during operation.

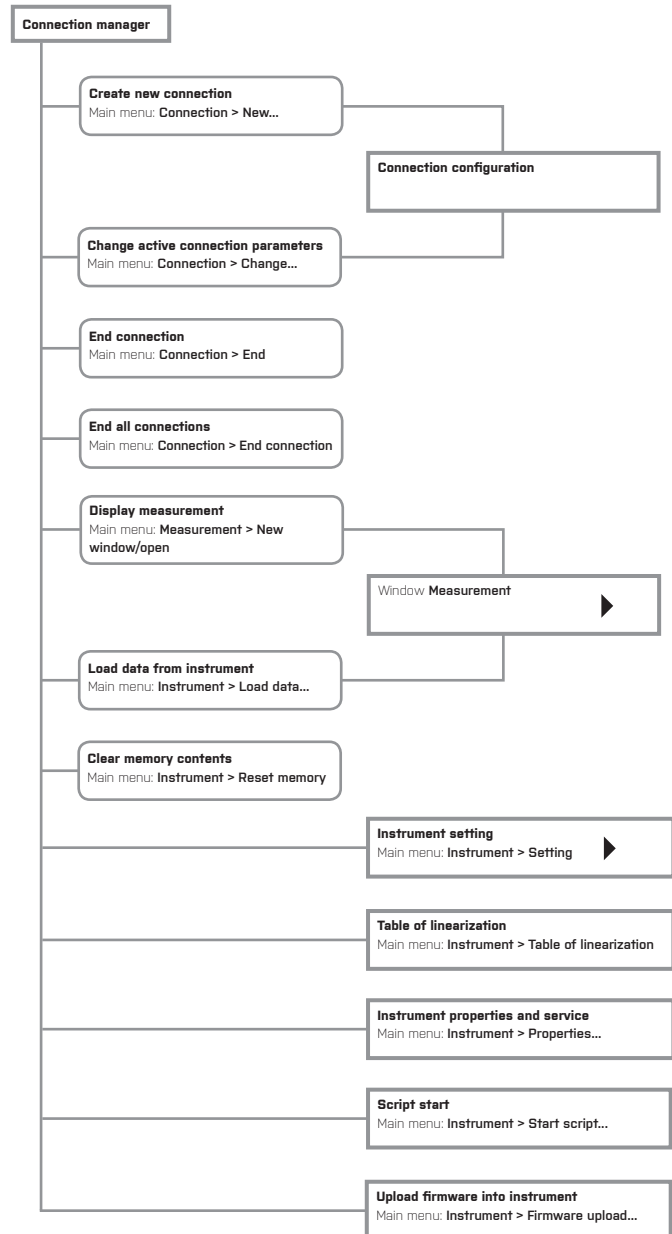
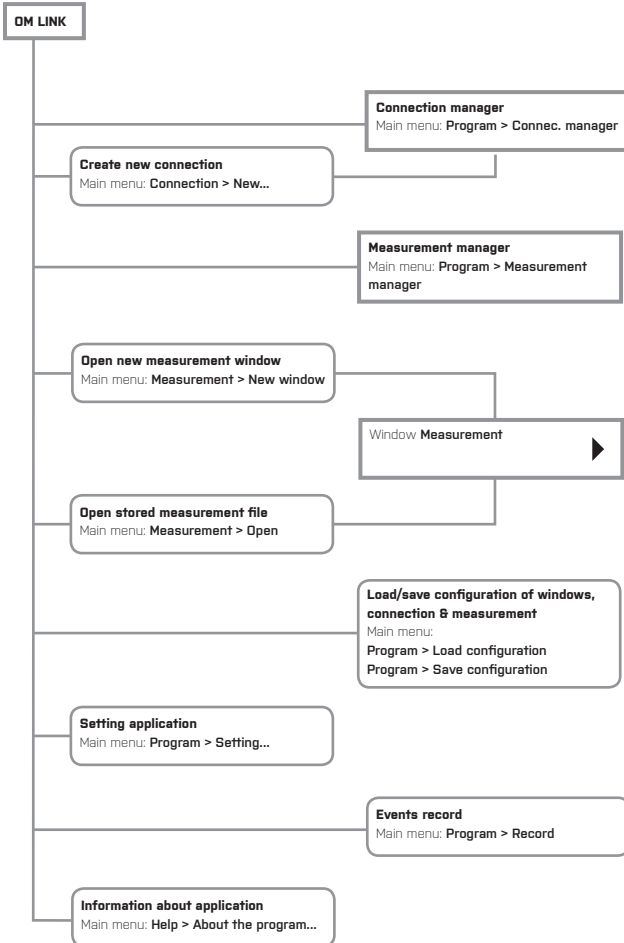
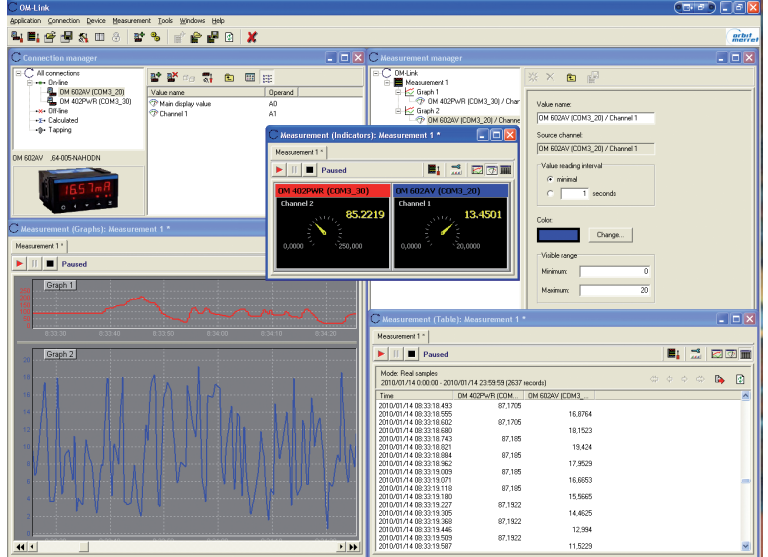

CONNECTION MANAGER

Connection manager facilitates creating and cancelling connections, provides their list classified as per Type, noting the basic parameters and measurable values (channels), and serves as home location for starting measurements, configuring the OM instruments, projecting their properties etc.

Connection is the key entity of the OM link application - it represents physical or virtual connection with an OM device and is the basic subject of many application functions.

Connection modes:

- **On-line**, represents a physical connection to an OM device.
- **Off-line**, serves for projection of instrument menu and its configuration for later use in the on-line mode.
- **Mathematic**, represents a mathematical operation with measured data acquired from other connections (on-line)
- **Line tapping**, serves to analyse communication in progress among autonomous measuring systems

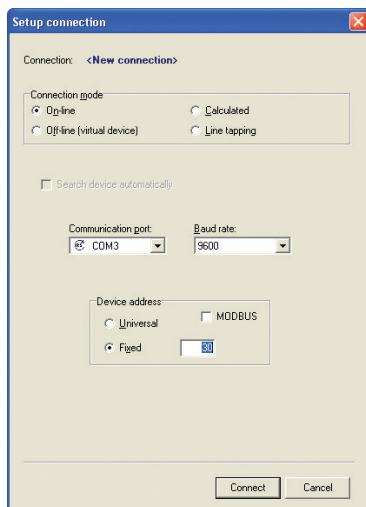

MEASUREMENT MANAGER

Measurement manager facilitates creating and cancelling measurement files, graphs and individual data, provides their structured overview and enables modification of graph and value parameters.

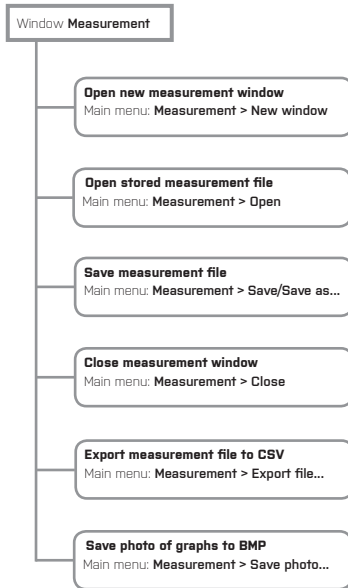

WINDOW MEASUREMENT

Window Measurement provides view of historic and current process of measuring certain quantities and their groups. The window offers three possible modes of viewing the measured data:

- 1) graphs - they reflect the historic course of measurement in selectable time range. By means of the control panel in this mode it is possible to shift the displayed time period, modify the displayed time range (from 1 sec up to 15 days) and set additional parameters of graph projection, (names, date on time axis).
- 2) Indicators – they show current values of the measured data
- 3) Table – depicts the history of the measuring process in table numeric format.

By means of the control panel in this mode it is possible to switch between the projection of interpolated values in particular time steps and the projection of truly taken sample values.

The graph and table modes also enable to discontinue the measurement in process and restart it again. At the same time it is also possible to specify whether upon restarting the process the measurement retains its former course (history) and the measurement is reassumed or whether it starts anew and the history is cancelled.

Values from the instrument may be added to the measurement e.g. from the Connection manager by selecting certain instrument channel from the on-line connection (or calculated connection or line tapping connection) and dragging it over to the Window Measurement. This way new values (quantities) may also be incorporated in already existing graphs (in case of graph mode), i.e. two quantities in one graph with common standard and time axis.

Structuring the quantities and graphs and changing their parameters (names, ranges, colors) may also be performed in Measurement Manager.

Time	DM 402PWR (COM3_30) / Channel 2	DM 602AV (COM3_20) / Channel 1
2010/01/14 08:33:18.455	87,1705	16,8764
2010/01/14 08:33:18.955	87,1705	16,8764
2010/01/14 08:33:18.602	87,1705	16,8153
2010/01/14 08:33:18.690	87,185	19,424
2010/01/14 08:33:18.743	87,185	17,9529
2010/01/14 08:33:18.821	87,185	16,6553
2010/01/14 08:33:18.884	87,185	15,5665
2010/01/14 08:33:18.962	87,1922	14,4625
2010/01/14 08:33:19.019	87,1922	12,994
2010/01/14 08:33:19.071	87,1922	11,5223
2010/01/14 08:33:19.118	87,1973	9,69108
2010/01/14 08:33:19.180	87,1973	7,68395
2010/01/14 08:33:19.227	87,1973	5,67563
2010/01/14 08:33:19.274	87,1824	3,2857
2010/01/14 08:33:19.305	87,1824	3,54333
2010/01/14 08:33:19.368	87,1824	5,31028
2010/01/14 08:33:19.446	87,1947	6,63317
2010/01/14 08:33:19.509	87,1947	7,95616
2010/01/14 08:33:19.597	87,1947	9,39384
2010/01/14 08:33:19.634	87,1947	11,048
2010/01/14 08:33:19.696	87,1761	12,8129
2010/01/14 08:33:19.743	87,1761	14,3593
2010/01/14 08:33:19.805	87,1761	14,3593
2010/01/14 08:33:19.852	87,1761	14,3593
2010/01/14 08:33:19.915	87,1761	14,3593
2010/01/14 08:33:19.977	87,1761	14,3593
2010/01/14 08:33:20.055	87,1761	14,3593
2010/01/14 08:33:20.118	87,1761	14,3593
2010/01/14 08:33:20.196	87,1761	14,3593
2010/01/14 08:33:20.259	87,1761	14,3593
2010/01/14 08:33:20.321	87,1761	14,3593
2010/01/14 08:33:20.388	87,1761	14,3593
2010/01/14 08:33:20.430	87,1761	14,3593
2010/01/14 08:33:20.507	87,1761	14,3593
2010/01/14 08:33:20.569	87,1761	14,3593
2010/01/14 08:33:20.635	87,1761	14,3593
2010/01/14 08:33:20.727	87,1761	14,3593
2010/01/14 08:33:20.805	87,1761	14,3593
2010/01/14 08:33:20.868	87,1761	14,3593
2010/01/14 08:33:20.946	87,1761	14,3593
2010/01/14 08:33:20.993	87,1761	14,3593
2010/01/14 08:33:21.055	87,1761	14,3593
2010/01/14 08:33:21.102	87,1761	14,3593

DEVICE SETUP

One of the main features of the DM Link program is the opportunity to set up the instruments comfortably from your computer.

- Setting the device values and parameters
- View of the complete setting menu (PROF/LIGHT/USER)
- Individual configuration of the complete menu
- Device setup export and import

All existing items may be set, even those that are inaccessible or blocked in the instrument.

In majority of the items on the instrument menu their attribute may be set for the "User menu" (see/change/ hide) and in addition it is possible to remove or add any item from the "LIGHT menu". Client menu of the instrument may be compiled eventually this way for given application and level of service proficiency.

Each setting of the device menu may be stored in a file and used for configuration of other instruments. An advantage is also the possibility of sending complete menu via e-mail directly to the technical support of the manufacturer.

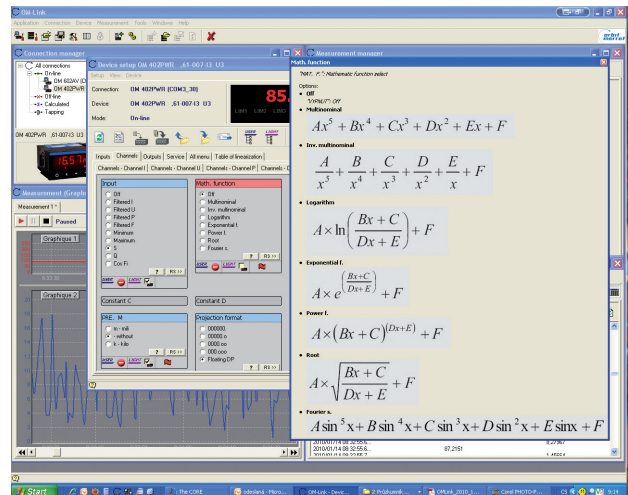
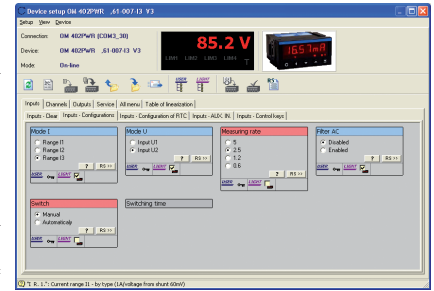

In Properties and Service you will find complete information about the instrument

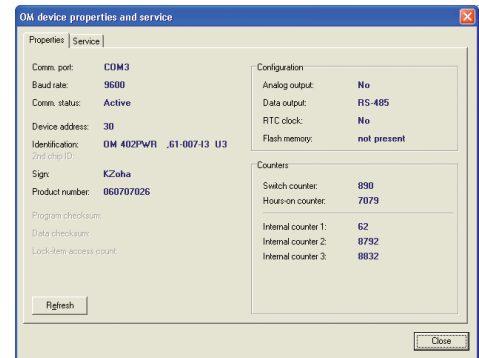



- 4-DIGIT PROGRAMMABLE PROJECTION
- MULTIFUNCTION INPUT (DC, PM, RTD, T/C, DU)
- DIGITAL FILTERS, TARE, LINEARIZATION
- SIZE OF DIN 96 x 48 MM
- POWER SUPPLY 80...250 V AC/DC
- Option
 - Comparators • Data output • Analog output
 - Data record • Power supply 10...30 V AC/DC
 - Three-color display - 20 mm

OPERATION

The instrument is set and controlled by five control keys located on the front panel. All programmable settings of the instrument may be performed in three adjusting modes:

LIGHT MENU is protected by optional number code and contains solely items necessary for instrument setting

PRDFI MENU is protected by optional number code and contains complete instrument setting

USER MENU may contain arbitrary items from the programming menu (LIGHT/PRDFI), which determine the right [see, change]. Access w/o password.

Standard equipment is the OM Link interface, which together with operation program enables modification and filing of all instrument settings as well as perform firmware updates (with OML cable). The program is also designed for visualization and filing of measured values from more instruments.

All settings are stored in the EEPROM memory (they hold even after the instrument is switched off). The measured units may be projected on the display.

OPTION

COMPARATORS are assigned to monitor one, two, three or four limit values with relay output. The user may select limits regime: LIMIT/DOSING/FROM-TO. The limits have adjustable hysteresis within the full range of the display as well as selectable delay of the switch-on in the range of 0...99,9 s. Reaching the preset limits is signalled by LED and simultaneously by the switch-on of the relevant relay.

DATA OUTPUTS are for their rate and accuracy suitable for transmission of the measured data for further projection or directly into the control systems. We offer an isolated RS232 and RS485 with the ASCII/MESSBUS/MODBUS/PROFIBUS protocol.

ANALOG OUTPUTS will find their place in applications where further evaluating or processing of measured data is required in external devices. We offer universal analog output with the option of selection of the type of output - voltage/current. The value of analog output corresponds with the displayed data and its type and range are selectable in menu.

MEASURED DATA RECORD is an internal time control of data collection. It is suitable where it is necessary to register measured values. Two modes may be used. FAST is designed for fast storage (40 records/s) of all measured values up to 8 000 records. Second mode is RTC, where data record is governed by Real Time with data storage in a selected time segment and cycle. Up to 266 000 values may be stored in the instrument memory. Data transmission into PC via serial interface RS232/485 and OM Link.

OM 402



The OM 402 model series are 4-digit panel programmable instruments designed for maximum efficiency and user comfort while maintaining their favourable price.

Type OM 402UNI is a multifunction instrument with the option of configuration for 8 various input options, easily configurable in the instrument menu. By further options of input modules it is feasible to measure larger ranges of DC voltage and current or increase the number of inputs up to 4 (applies for PM).

The instrument is based on an 8-bit microcontroller and multichannel 24-bit sigma-delta converter, which secures high accuracy, stability and easy operation of the instrument.

OM 402UNI

- DC VOLTMETER AND AMMETER
- PROCESS MONITOR
- OHMMETER
- THERMOMETER FOR PT/CU/NI/THERMOCOUPLES
- DISPLAY UNIT FOR LINEAR POTENTIOMETERS

STANDARD FUNCTIONS

PROGRAMMABLE PROJECTION

Selection: of input type and measuring range

Measuring range: adjustable as fixed or with automatic change (OHM)

Setting: manual, in menu optional projection on the display may be set for both limit values of the input signal, e.g. input 0...39,99 V > 0...850.0

Projection: -99999...999999

EXCITATION

Range: 5...24 VDC, for feeding of sensors and transmitters

COMPENSATION

Of conduct (RTD, OHM): automatic (3- and 4-wire) or manual in menu (2-wire)

of conduct in probe (RTD): internal connection (conduct resistance in measuring head)

of CJC (T/C): manual or automatic, in menu it is possible to perform selection of the type of thermocouple and compensation of cold junctions, which is adjustable or automatic (temperature at the input brackets)

LINEARIZATION

Linearization: through linear interpolation in 50 points (solely via OM Link)

DIGITAL FILTERS

Floating/Exp./Arithmetic average: from 2...30/100/100 measurements

Rounding: setting the projection step for display

MATHEMATIC FUNCTIONS

Min/max. value: registration of min/max. value reached during measurement

Tare: designed to reset display upon non-zero input signal

Peak value: the display shows only max. or min. value

Mat. operations: polynome, 1/x, logarithm, exponential, power, root, sin x and mathematic operations between inputs

EXTERNAL CONTROL

Lock: control keys blocking

Hold: display/instrument blocking

Tare: tare activation

Resetting MM: resetting min/max value

TECHNICAL DATA

PROJECTION

Display: -99999...999999, red or green 14-segment LED, digit height 14mm,
-999...9999, red/green/orange 7-segment LED, height 20mm
Description: last two characters on the display may be used for description of measured quantities (adjustable in the menu)
Decimal point: setting - in menu
Brightness: setting - in menu

INSTRUMENT ACCURACY

TK: 50 ppm/°C
Accuracy: ±0,1% of range + 1 digit [for projection 9999 and 5 meas./s] ±0,15% of range + 1 digit **RTD, T/C**
Accuracy of cold junction measurement: ±1,5°C
Rate: 0,1...40 meas./s
Overload capacity: 2x; 10x (t < 30 ms) - not for > 250 V and 5 A
Linearization: by linear interpolation in 50 points
Digital filters: Exp./Floating/Arithmetic average, Rounding
Functions: offset, Min/max value, Tare, Peak value, Mat. operations
Ext. control: HOLD, L/DCK, Tare, Min/Max
Data record: measured data record into instrument memory
RTC: 15 ppm/°C, time-date-display value, < 266k data
FAST [UNI] - display value, < 8k data
Resolution [RTD, T/C]: 1°/0,1°/0,01°C
Watch-dog: reset after 0,4 s
OM Link: Company communication interface for operation, setting and update of instruments
Calibration: at 25°C and 40% r.h.

COMPARATOR

Type: digital, setting in menu, contact switch < 30 ms
Limits: -99999...999999
Hysteresis: 0...999999
Delay: 0...99,9 s
Output: 2x relays Form A [250 VAC/30 VDC, 3 A] and 2x Form C relays [250 VAC/50 VDC, 3 A], 2x/4x open collectors, 2x SSR, 2x bistable relays

DATA OUTPUT

Protocol: ASCII, MESSBUS, MODBUS - RTU, PROFIBUS
Data format: 8 bit + no parity + 1 stop bit [ASCII]
7 bit + even parity + 1 stop bit [Messbus]
Rate: 600...230 400 Baud, 0,0096...12 Mbaud [PROFIBUS]
RS 232: isolated
RS 485: isolated, addressing (max. 31 instruments)

ANALOG OUTPUT

Type: isolated, programmable with 16-bit D/A converter, type and range are selectable in programming mode
Non-linearity: 0,1% of range
TK: 15 ppm/°C
Rate: response to change of value < 1 ms
Ranges: 0...2,5/10 V, ±10 V, 0...5 mA, 0/4...20 mA [comp. < 600 Q/12 V or 1 000 Q/24 V]

EXCITATION

Adjustable: 5...24 VDC/max. 1,2 W

POWER SUPPLY

10...30 V AC/DC, ±10%, max. 13,5 VA, PF ≥ 0,4, I_{STP} < 40 A/1 ms
80...250 V AC/DC, ±10%, max. 13,5 VA, PF ≥ 0,4, I_{STP} < 40 A/1 ms
Power supply is protected by a fuse inside the instrument

MECHANIC PROPERTIES

Material: Noryl GFN2 SE1, incombustible UL 94 V-1
Dimensions: 96 x 48 x 120 mm
Panel cutout: 90,5 x 45 mm

OPERATING CONDITIONS

Connection: connector terminal board, section < 1,5/2,5 mm²
Working temperature: -20°...60°C
Storage temperature: -20°...80°C
Cover: IP64 [front panel only]
El. safety: EN 61010-1, A2
Dielectric strength: 4 kVAC after 1 min between supply and input 4 kVAC after 1 min between supply and data/analog output 2,5 kVAC after 1 min between input and data/analog output
Insulation resistance: for pollution degree II, measuring cat. III. Power supply > 670 V [Z], 300 V [DI] input, output, Exc. > 300 V [Z], 150 V [DI]
EMC: EN 61326-1
Seismic capacity: IEC 980: 1993, par. 6
SW validation: Class B, C in compliance with IEC 62138, 61226

PI - Primary insulation, DI - Double insulation

MEASURING RANGES

OM 402 is a multifunction instrument available in following types and ranges

type UNI, standard [code „0”]

DC ±60/±150/±300/±1 200 mV
PM 0...5/20 mA/4...20 mA; ±2/±5/±10/±40 V
OHM 0...100 Q/0...1/10/100 kQ/Auto
RTD Pt 250/100/500/1000
Cu Cu 50/100
Ni Ni 1 000/10 000
T/C J/K/T/E/B/S/R/N/L
DU Linear potentiometer [min. 500 Q]

type UNI, Option A

DC ±0,1/±0,25/±0,5/±2/±5 A; ±100/±250/±500 V

type UNI, Option B [expansion about three inputs]

PM 3x 0...5/20 mA/4...20 mA; ±2/±5/±10/±40 V

CONNECTING INDIVIDUAL INPUTS

	INPUT „I”	INPUT „U”
DC		±60/±150/±300/±1200 mV
PM	0...5/0...20 mA/4...20 mA	±2/±5/±10/40 V

ORDER CODE SPECIFICATION

	UNI
W/D	standard
A	+0,1/±0,25/±0,5/±2/±5 A ±100/±250/±500 V
B	Expansion about three inputs [PM]
K	
P	
S	
U	
Z	on request

CONNECTION

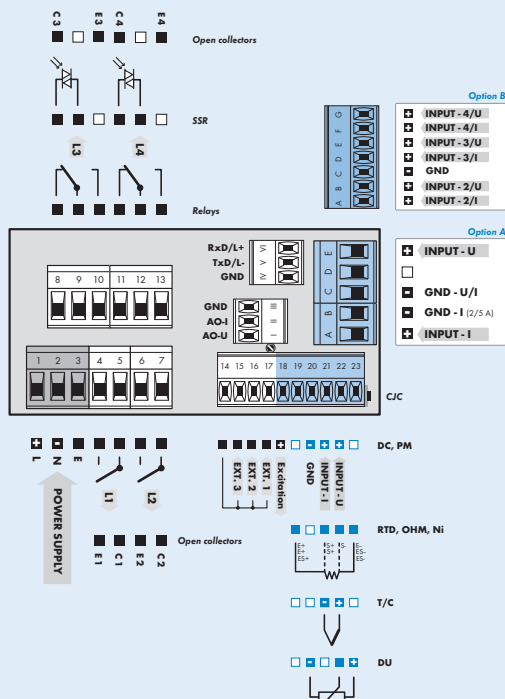

ORDER CODE

OM 402UNI

□ □ □ □ - □ □ □ □ □ □ □ □ □ □ 1 □ □ □ □ - □ □

Power supply	10...30 V AC/DC 80...250 V AC/DC	0								
Option, see table „Order code specification”		1								
Comparators	no 1x relay [Form A] 2x relays [Form A] 3x relays [2x Form A + 1x Form C] 4x relays [2x Form A + 2x Form C] 2x open collectors 4x open collectors 2x open collectors + 2x relays [Form C] 2x relays [Form C] 2x SSR 2x relays, bistabil 1x relay [Form C]	0 1 2 3 4 5 6 7 8 9 A B								
Analog output	no yes [Compensation < 600 Q/12 V] yes [Compensation < 1000 Q/24 V]	0 1 2								
Data output	no RS 232 RS 485 MODBUS PROFIBUS	0 1 2 3 4								
Excitation	yes		1							
Data record	no RTC FAST [only for UNI]			0 1 2						
Display color	red [14mm] green [14mm] red/green [20mm]							1 2 3		
Other	customer version, do not fill in SW validation - IEC 62138, IEC 61226									00 VS

Default execution is shown in bold

* Launch for sale has not been set



- 6-DIGIT PROGRAMMABLE PROJECTION
- SIZE OF DIN 96 x 48 MM
- POWER SUPPLY 80...250 V AC/DC
- Option
 - Excitation • Comparators • Data output • Analog output
 - Three-color display - 20 mm • Power supply 10...30 V AC/DC

OM 602AV

OMLINK

The OM 602AV is a programmable analog output.

The instrument is based on an 8-bit processor that secures high accuracy, stability and easy operation of the instrument.

OM 602AV
PROGRAMMABLE OUTPUT

OPERATION

The instrument is set and controlled by five control keys located on the front panel. All programmable settings of the instrument may be performed in three adjusting modes:

LIGHT MENU is protected by optional number code and contains solely items necessary for instrument setting

PROFI MENU is protected by optional number code and contains complete instrument setting

USER MENU may contain arbitrary items from the programming menu (LIGHT/PROFI), which determine the right [see, change]. Access w/o password.

Standard equipment is the OM Link interface, which together with operation program enables modification and filing of all instrument settings as well as perform firmware updates (with OML cable). The program is also designed for visualization and filing of measured values from more instruments.

All settings are stored in the EEPROM memory (they hold even after the instrument is switched off). The measured units may be projected on the display.

OPTION

EXCITATION is suitable for feeding of sensors and transmitters. It is isolated, with continuously adjustable value in the range of 5...24 VDC.

COMPARATORS are assigned to monitor one, two, three or four limit values with relay output. The user may select limits regime: LIMIT/DOSING/FROM-TD. The limits have adjustable hysteresis within the full range of the display as well as selectable delay of the switch-on in the range of 0...99,9 s. Reaching the preset limits is signalled by LED and simultaneously by the switch-on of the relevant relay.

DATA OUTPUTS are for their rate and accuracy suitable for transmission of the measured data for further projection or directly into the control systems. We offer an isolated RS232 and RS485 with the ASCII/MESSBUS/MODBUS/PROFIBUS protocol.

ANALOG OUTPUTS will find their place in applications where further evaluating or processing of measured data is required in external devices. We offer universal analog output with the option of selection of the type of output - voltage/current. The value of analog output corresponds with the displayed data and its type and range are selectable in menu.

STANDARD FUNCTIONS

PROGRAMMABLE PROJECTION

Projection: -99999...999999 with fixed or floating DP

Setting: optional projection may be set for both limit values of the AO range in „CM“

DIGITAL FILTERS

Exponen. average: from 2...255 measurements

„n“ value: from 2...100 measurements

Rounding: setting the projection step for display

FUNCTIONS

Min/max. value: registration of min/max. value reached during measurement

Mat. operations: polynome, 1/x, logarithm, exponential, power, root, sin x

Type of output signal: sinus/saw/triangle/rectangle/random functions (selected by control keys or on inputs 1 and 2)

EXTERNAL CONTROL

Hold: display/instrument blocking

Lock: control keys blocking

Resetting MM: resetting min/max value

Functions: control of optional functions from instrument menu

TECHNICAL DATA

PROJECTION

Display: 999999, red or green 14-segment LED, digit height 14 mm, 99999, red/green/orange 7-segment LED, digit height 20 mm
Decimal point: setting - in menu
Brightness: setting - in menu

INSTRUMENT ACCURACY

Input filters: Filtration constant, Rounding
Functions: HOLD, LOCK, Digital filters, Tare
DM Link: Company communication interface for operation, setting and update of instruments
Calibration: at 25°C and 40% r.h.

COMPARATOR

Type: digital, setting in menu, contact switch < 30 ms
Limits: -99999...999999
Hysteresis: 0...999999
Delay: 0...99,9 s
Output: 2x relays Form A (250 VAC/30 VDC, 3 A) and 2x Form C relays (250 VAC/50 VDC, 3 A), 2x/4x open collectors, 2x SSR, 2x bistable relays

DATA OUTPUT

Protocol: ASCII, MESSBUS, MODBUS - RTU, PROFIBUS
Data format: 8 bit + no parity + 1 stop bit (ASCII)
 7 bit + even parity + 1 stop bit (Messbus)
Rate: 600...230 400 Baud
 9 600 Baud...12 Mbaud (PROFIBUS)
RS 232: isolated
RS 485: isolated, addressing (max. 31 instruments)

ANALOG OUTPUT

Type: isolated, programmable with 16-bit D/A converter, type and range are selectable in programming mode
Non-linearity: 0.1% of range
TK: 15 ppm/°C
Rate: response to change of value < 1 ms
Ranges: 0...2/5/10 V, ±10 V, 0...5 mA, 0/4...20 mA [comp. < 600 Ω/12 V or 1 000 Ω/24 V]

EXCITATION

Adjustable: 5...24 VDC/max. 1.2 W

POWER SUPPLY

10...30 V AC/DC, ±10%, max. 13,5 VA, PF ≥ 0,4, I_{3TP} < 40 A/1 ms
 80...250 V AC/DC, ±10%, max. 13,5 VA, PF ≥ 0,4, I_{3TP} < 40 A/1 ms
Power supply is protected by a fuse inside the instrument

MECHANIC PROPERTIES

Material: Noryl GFN2 SE1, incombustible UL 94 V-1
Dimensions: 96 x 48 x 120 mm
Panel cutout: 90,5 x 45 mm

OPERATING CONDITIONS

Connection: connector terminal board, section < 1,5/2,5 mm²
Stabilization period: within 15 minutes after switch-on
Working temperature: -20°...80°C
Storage temperature: -20°...85°C
Cover: IP64 (front panel only)
El. safety: EN 61010-1, A2
Dielectric strength: 4 kVAC after 1 min between supply and input 4 kVAC after 1 min between supply and data/analog output 4 kVAC after 1 min between supply and relay output 2,5 kVAC after 1 min between input and data/analog output
Insulation resistance: for pollution degree II, measuring cat. III. Power supply > 670 V [ZI], 300 V [DI] input, output, Exc. > 300 V [ZI], 150 V [DI]
EMC: EN 61326-1
Seismic capacity: IEC 980: 1993, par. 6
SW validation: Class B, C in compliance with IEC 62138, 61226

PI - Primary insulation, DI - Double insulation

CONNECTION

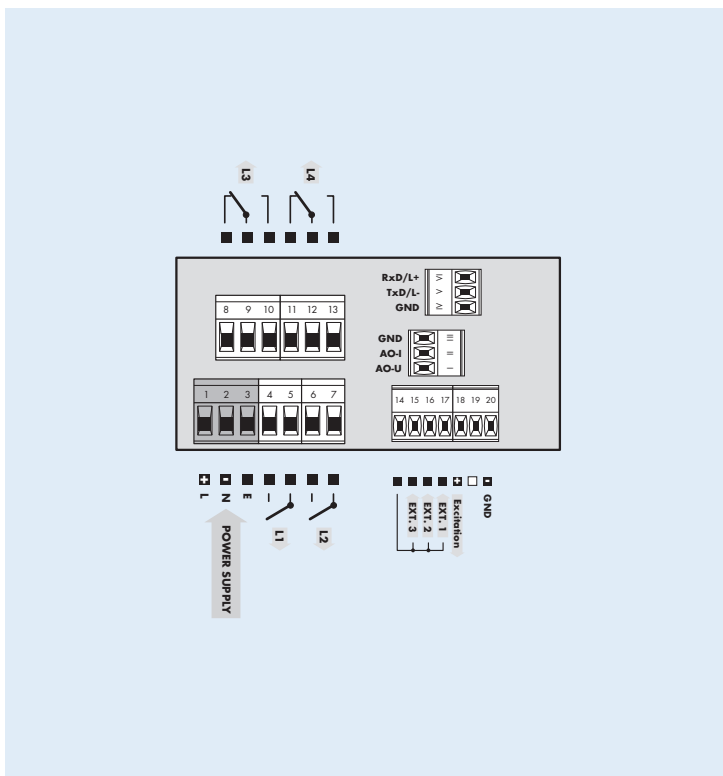

ORDER CODE

OM 602AV

□□ - □□□□□□ - □□

Power supply	10...30 V AC/DC 80...250 V AC/DC	0 1				
Comparators	none 1x relay (Form A) 2x relays (Form A) 3x relays (2x Form A + 1x Form C) 4x relays (2x Form A + 2x Form C) 2x open collectors 4x open collectors 2x open collectors + 2x relays (Form C) 2x relays (Form C) 2x SSR 2x bistable relays 1x relay (Form C)	0 1 2 3 4 5 6 7 8 9 A B				
Data output	none RS 232 RS 485 MODBUS PROFIBUS	0 1 2 3 4				
Excitation	no yes	0 1				
Display color	red (14 mm) green (14 mm) red/green (20 mm)	1 2 3				
Other	customer version, do not fill in SW validation - IEC 62138, IEC 61226				00 VS	

Default execution is shown in bold

* Launch for sale has not been set



- 8-CHANNEL LOGGER
- 4-DIGIT PROGRAMMABLE PROJECTION
- DIGITAL FILTER, TARE, LINEARIZATION
- SIZE OF DIN 96 x 48 MM
- POWER SUPPLY 80...250 V AC/DC
- Option
 - Comparators • Data output • Analog output
 - Data record • Power supply 10...30 V AC/DC

OPERATION

The instrument is set and controlled by five control keys located on the front panel. All programmable settings of the instrument may be performed in three adjusting modes:

LIGHT MENU is protected by optional number code and contains solely items necessary for instrument setting

PROFI MENU is protected by optional number code and contains complete instrument setting

USER MENU may contain arbitrary items from the programming menu (LIGHT/PROFI), which determine the right (see, change). Access w/o password.

Standard equipment is the OM Link interface, which together with operation program enables modification and filing of all instrument settings as well as perform firmware updates (with OML cable). The program is also designed for visualization and filing of measured values from more instruments.

All settings are stored in the EEPROM memory (they hold even after the instrument is switched off).

The measured units may be projected on the display.

OPTION

COMPARATORS are assigned to monitor four or eight limit values with relay output. For each input the user may select an arbitrary number of relays with the regime: LIMIT/FROM-TO. The limits have adjustable hysteresis within full range of the display and selectable delay of the switch-on. Reaching the preset limits is signalled by LED and simultaneously by the switch-on of the relevant relay.

DATA OUTPUTS are for their rate and accuracy suitable for transmission of the measured data for further projection or directly into the control systems. We offer an isolated RS232 and RS485 with the ASCII/MESSBUS/MODBUS/PROFIBUS protocol.

ANALOG OUTPUT will find their place in applications where further evaluating or processing of measured data is required in external devices. We offer universal analog output with the option of selection of the type of output - voltage/current and the option of assigning it to arbitrary input. The value of analog output corresponds with the displayed data and its type and range are selectable in menu.

MEASURED DATA RECORD is an internal time control of data collection. It is suitable where it is necessary to register measured values. Two modes may be used. FAST is designed for fast storage (80 records/s) of all measured values up to 8 000 records. Second mode is RTC, where data record is governed by Real Time with data storage in a selected time segment and cycle. Up to 532 000

OMU 408UNI

OMLINK

OMU 408UNI is an 8-channel logger designed for maximum efficiency and user comfort while maintaining its favourable price. It is a multifunction instrument with the option of configuration for 8 various input options, easily configurable in the instrument menu.

The instrument is based on an 8-bit microcontroller with a multichannel 24-bit sigma-delta converters that secure high accuracy, stability and easy operation of the instrument.

Great quality of the instrument, owing to the high rate of sampling on individual channels, is the chance to evaluate all measuring inputs at the same time.

OMU 408UNI

DC VOLTMETER AND AMMETER

PROCESS MONITOR

OHMMETER

THERMOMETER FOR PT/CU/NI/TERMOCOUPLES

DISPLAY UNIT FOR LINEAR POTENTIOMETERS

values may be stored in the instrument memory. Data transmission into PC via serial interface RS232/485 and OM Link.

STANDARD FUNCTIONS

PROGRAMMABLE PROJECTION

Selection: of input type and measuring range

Setting: manual, in menu optional projection on the display may be set for both limit values of the input signal

Projection: -999...9999

SWITCHING OF INPUTS

Manual: by control key on the front panel or from the outside (EXT. inputs)

Automatic: by a set time interval

COMPENSATION

of conduct (RTD, OHM): automatic (3- and 4-wire) or manual in menu (2-wire)

of conduct in probe (RTD): internal connection (conduct resistance in measuring head)

of CJC (T/C): manual or automatic, in menu it is possible to perform selection of the type

of thermocouple and compensation of cold junctions, which is adjustable or automatic

(temperature at the input brackets)

LINEARIZATION

Linearization: by linear interpolation in 255 points/8 channels (solely via OM Link)

DIGITAL FILTERS

Floating/Exp./Arithmetic average: from 2...30/100/100 measurements

Rounding: setting the projection step for display

FUNCTIONS

Min/max. value: registration of min/max. value reached during measurement

Tare: designed to reset display upon non-zero input signal

Peak value: the display shows only max. or min. value

Mat. operations: polynome, 1/x, logarithm, exponential, power, root, sin x and at the same

time between inputs - sum, difference, product, quotient

EXTERNAL CONTROL

EXT inputs: switching inputs from superior systems or control Hold, Lock, Tare and

resetting Min/max. value

TECHNICAL DATA

PROJECTION

Measured value: -999...9999, red or green 14-segment LED, digit height 14 mm
Channel identification: 9, red or green 7-segment LED, digit height 9,1 mm
Measuring units: 99, red or green 7-segment LED, digit height 9,1 mm
Decimal point: setting - in menu
Brightness: setting - in menu

INSTRUMENT ACCURACY

TK: 50 ppm/°C
Accuracy: ±0,2% of range + 1 digit (for projection 9999 and 5 meas./s)
Accuracy of cold junction measurement: ±1,5°C
Rate: 1,3...40 meas./s
Overload capacity: 2x; 10x (t < 30 ms)
Resolution: 0,1°C (RTD), 1°C (T/C)
Compensation leads: max. 40 Ω
Linearization: by linear interpolation in 255 points/for 8 Chan.
Compensation st. concü: manual 0°...99°C or automatic
Digital filters: Exp/Floating/Arithmetic average, Rounding
Functions: Min/max value, Tare, Peak value, Mat. operations
Ext. control: HOLD, LOCK, Tare
Data record: measured data record into instrument memory
RTC - 15 ppm/°C, time-date-display value, < 532k data
FAST - display value, < 8k data
Watch-dog: reset after 0,4 s
OM Link: Company communication interface for operation, setting and update of instruments
Calibration: at 25°C and 40% r.h.

COMPARATOR

Type: digital, setting in menu, limit may be assigned to arbitrary input, contact switch < 30 ms
Limits: -999...9999
Hysteresis: 0...9999
Delay: 0...99,9 s
Output: 4x/8x Form A relays (250 VAC/30 VDC, 3 A)

DATA OUTPUT

Protocol: ASCII, MESSBUS, MODBUS - RTU, PROFIBUS
Data format: 8 bit + no parity + 1 stop bit (ASCII)
7 bit + even parity + 1 stop bit (Messbus)
Rate: 600...230 400 Baud
9 600 Baud...12 Mbaud (PROFIBUS)
RS 232: isolated
RS 485: isolated, addressing (max. 31 instruments)

ANALOG OUTPUT

Type: isolated, programmable with 16-bit D/A converter, type and range are selectable in programming mode
Non-linearity: 0,1% of range
TK: 15 ppm/°C
Rate: response to change of value < 1 ms
Ranges: 0...2/5/10 V, ±10 V, 0...5 mA, 0/4...20 mA (comp. < 600 Ω/12 V)

POWER SUPPLY

10...30 V AC/DC, ±10%, max. 13,5 VA, PF≥0,4, I_{STB}< 40 A/1 ms
 80...250 V AC/DC, ±10%, max. 13,5 VA, PF≥0,4, I_{STB}< 40 A/1 ms
 Power supply is protected by a fuse inside the instrument

MECHANIC PROPERTIES

Material: Noryl GFN2 SE1, incombustible UL 94 V-1
Dimensions: 96 x 48 x 120 mm
Panel cutout: 90,5 x 45 mm

OPERATING CONDITIONS

Connection: connector terminal board, section < 1,5/2,5 mm²
Stabilization period: within 15 minutes after switch-on
Working temperature: -20°...60°C
Storage temperature: -20°...85°C
Cover: IP64 (front panel only)
El. safety: EN 61010-1, A2
Dielectric strength: 4 kVAC after 1 min between supply and input
 4 kVAC after 1 min between supply and data/analog output
 4 kVAC after 1 min between supply and relay output
 2,5 kVAC after 1 min between input and data/analog output
Insulation resistance: for pollution degree II, measuring cat. III.
 Power supply > 670 V (Z1), 300 V (D1)
 input, output, F > 300 V (Z1), 160 V (D1)
EMC: EN 61326-1
Seismic capacity: IEC 980: 1993, par. 6
SW validation: class B, C in compliance with IEC 62138, 61226

PI - Primary insulation, DI - Double insulation

MEASURING RANGES

OMU 408UNI is a multifunction instrument available in following types and ranges

DC: ±60/±150/±300/±1 200 mV
PM: 0...5/20 mA/4...20 mA; ±2/±5/±10/±40 V
OHM: 0...100 Ω/0...1/10/100 kΩ/Auto
RTD: Pt 50/100/500/1 000
Cu: Cu 50/100
Ni: Ni 1 000/10 000
T/C: J/K/T/E/B/S/R/N/L
DU: Linear potentiometer (min. 500 Ω)

The inputs do not have galvanic separation among themselves!

Maximum difference between the GND brackets is 0,2V - DC, PM, TC, DU
 (internally connected through resistors 100Ω)

Brackets E - have to be on the same potential - OHM, RTD-Pt, RTD-Ni, RTD-Cu (internal galvanic connection)

CONNECTION

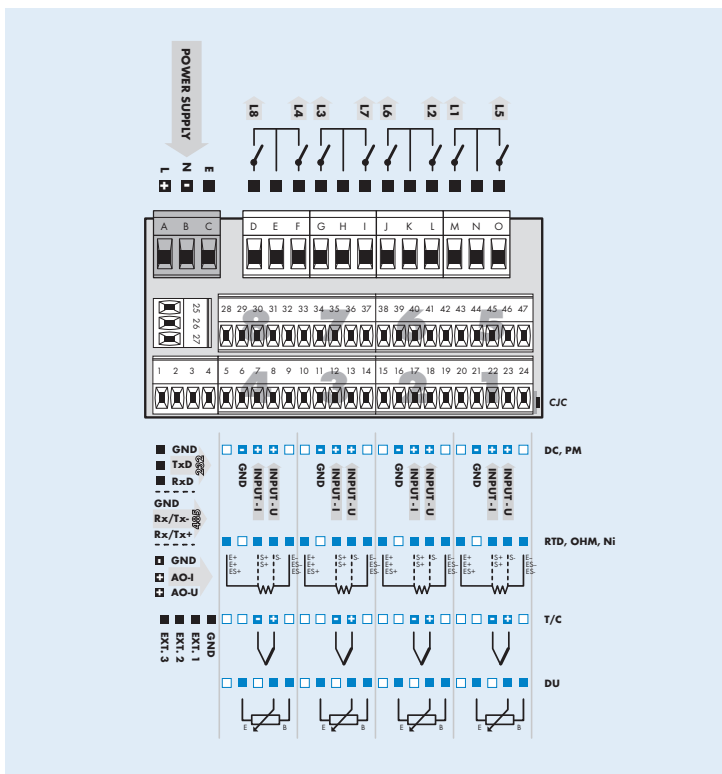

ORDER CODE

OMU 408UNI		-													
Power supply	10...30 V AC/DC 80...250 V AC/DC	0													
Number of inputs	4 inputs 8 inputs	0	1												
Comparators	none 4 relays 8 relays			0	1	2									
Output	none Analog RS 232 RS 485 PROFIBUS						0	1	2	3	4				
Data record	no RTC FAST*						0	1	2						
Display color**	red green									1	2				
Other	customer version, do not fill in SW validation - IEC 62138, IEC 61226													00	VS

*Recording measured values in the FAST mode is feasible from odd channels 1, 3, 5 and 7 only
 **Identification of channel and measuring units have second color

Default execution is shown in bold



- HORIZONTAL BARGRAPH - 30 LED WITH DISPLAY
- MULTIFUNCTION INPUT (DC, PM, RTD, T/C, DU)
- DIGITAL FILTERS, TARE, LINEARIZATION
- SIZE OF DIN 96 x 48 MM
- POWER SUPPLY 80...250 V AC/DC
- Option
 - Comparators • Data output • Analog output • Data record
 - Power supply 10...30 V AC/DC

OPERATION

The instrument is set and controlled by five control keys located on the front panel. All programmable settings of the instrument may be performed in three adjusting modes:

LIGHT MENU is protected by optional number code and contains solely items necessary for instrument setting

PROFI MENU is protected by optional number code and contains complete instrument setting

USER MENU may contain arbitrary items from the programming menu (LIGHT/PROFI), which determine the right (see, change). Access w/o password.

Standard equipment is the OM Link interface, which together with operation program enables modification and filing of all instrument settings as well as perform firmware updates (with OML cable). The program is also designed for visualization and filing of measured values from more instruments.

All settings are stored in the EEPROM memory (they hold even after the instrument is switched off).

OPTION

COMPARATORS are assigned to monitor one, two, three or four limit values with relay output. The user may select limits regime: LIMIT/DOSING/FROM-TO. The limits have adjustable hysteresis within the full range of the display as well as selectable delay of the switch-on in the range of 0...99,9 s. Reaching the preset limits is signalled by LED and simultaneously by the switch-on of the relevant relay.

DATA OUTPUTS are for their rate and accuracy suitable for transmission of the measured data for further projection or directly into the control systems. We offer an isolated RS232 and RS485 with the ASCII/MESSBUS/MODBUS/PROFIBUS protocol.

ANALOG OUTPUTS will find their place in applications where further evaluating or processing of measured data is required in external devices. We offer universal analog output with the option of selection of the type of output - voltage/current. The value of analog output corresponds with the displayed data and its type and range are selectable in menu.

MEASURED DATA RECORD is an internal time control of data collection. It is suitable where it is necessary to register measured values. Two modes may be used. FAST is designed for fast storage (40 records/s) of all measured values up to 8 000 records. Second mode is RTC, where data record is governed by Real Time with data storage in a selected time segment and cycle. Up to 266 000 values may be stored in the instrument memory. Data transmission into PC via serial interface RS232/485 and OM Link.

OMB 402

OMLINK

The OMB 402 model series are panel programmable three-color bar graphs with auxiliary display designed for maximum efficiency and user comfort while maintaining its favourable price.

The OMB 402UNI is a multifunction instrument with the option of configuration for 8 various input options, easily configurable in the instrument menu.

The instrument is based on an 8-bit microcontroller with a multichannel 24-bit sigma-delta converter, which secures high accuracy, stability and easy operation of the instrument.

OMB 402UNI

DC VOLTMETER AND AMMETER

PROCESS MONITOR

OHMMETER

THERMOMETER FOR PT/CU/NI/THERMOCOUPLES

DISPLAY UNIT FOR LINEAR POTENTIOMETERS

STANDARD FUNCTIONS

PROGRAMMABLE PROJECTION

Selection: of input type and measuring range

Measuring range: adjustable as fixed or with automatic change (OHM)

Setting: manual, in menu optional projection on the display may be set for both limit values of the input signal

Projection: 30 LED + 6-digit auxiliary display

COMPENSATION

Of conduct (RTD, OHM): automatic (3- and 4-wire) or manual in menu (2-wire)

Of conduct in probe (RTD): internal connection (conduct resistance in measuring head)

of CJC (T/C): manual or automatic, in menu it is possible to perform selection of the type of thermocouple and compensation of cold junctions, which is adjustable or automatic

LINEARIZATION

Linearization (DC, PM, DU): through linear interpolation in 50 points (solely via OM Link)

DIGITAL FILTERS

Floating/Exp./Arithmetic average: from 2...30/100/100 measurements

Rounding: setting the projection step for display

EXCITATION

Range: 5...24 VDC, for feeding of sensors and transmitters

MATHEMATIC FUNCTIONS

Min/max. value: registration of min/max. value reached during measurement

Tare: designed to reset display upon non-zero input signal

Peak value: the display shows only max. or min. value

Mat. operations: polynome, 1/x, logarithm, exponential, power, root, sin x and at the same time between inputs - sum, difference, product, quotient

EXTERNAL CONTROL

Lock: control keys blocking

Hold: display/instrument blocking

Tare: tare activation

Resetting MM: resetting min/max value

TECHNICAL DATA

PROJECTION

Display: 30 three-color LED with 6 digit aux.display (-99999...99999), digit height 9,1mm
Decimal point: setting - in menu
Brightness: setting - in menu

INSTRUMENT ACCURACY

TK: 60 ppm/°C
Accuracy: ±0,1% of range + 1 digit (for projection 9999 and 5 meas./s) ±0,16% of range + 1 digit **RTD, T/C**
Accuracy of cold junction measurement: ±1,5°C
Rate: 0,1...40 meas./s
Overload capacity: 2x; 10x (t < 30 ms) - not for > 250 V and 5 A
Linearization: by linear interpolation in 50 points
Digital filters: Exp./Floating/Arithmetic average, Rounding
Functions: Min/max. value, Tare, Peak value, Mat. operations
Ext. control: HOLD, LOCK, Tare, Reset
Data record: measured data record into instrument memory
RTC: - 16 ppm/°C, time-date-display value, < 266k data
FAST (UNI) - display value, < 8k data
Watch-dog: reset after 0,4 s
OM Link: Company communication interface for operation, setting and update of instruments
Calibration: at 25°C and 40% r.h.

COMPARATOR

Type: digital, setting in menu, contact switch < 30 ms
Limits: -99999...99999
Hysteresis: 0...999999
Delay: 0...99,9 s
Output: 2x relays Form A (250 VAC/30 VDC, 3 A) and 2x Form C relays (250 VAC/50 VDC, 3 A), 2x/4x open collectors, 2x SSR, 2x bistable relays

DATA OUTPUT

Protocol: ASCII, MESSBUS, MODBUS - RTU, PROFIBUS
Data format: 8 bit + no parity + 1 stop bit (ASCII)
 7 bit + even parity + 1 stop bit (Messbus)
Rate: 600...230 400 Baud
 9 600 Baud...12 Mbaud (PROFIBUS)
RS 232: Isolated
RS 485: Isolated, addressing (max. 31 instruments)

ANALOG OUTPUT

Type: Isolated, programmable with 16-bit D/A converter, type and range are selectable in programming mode
Non-linearity: 0,1% of range
TK: 15 ppm/°C
Rate: response to change of value < 1 ms
Ranges: 0...2/5/10 V, ±10 V, 0...5 mA, 0/4...20 mA (comp. < 600 Q/12 V or 1 000 Q/24 V)

EXCITATION

Adjustable: 5...24 VDC/max. 1,2 W

POWER SUPPLY

10...30 V AC/DC, ±10%, max. 13,5 VA, PF≥0,4, I_{STP}< 40 A/1 ms
 80...250 V AC/DC, ±10%, max. 13,5 VA, PF≥0,4, I_{STP}< 40 A/1 ms
 Power supply is protected by a fuse inside the instrument

MECHANIC PROPERTIES

Material: Noryl GFN2 SE1, incombustible UL 94 V-1
Dimensions: 96 x 48 x 120 mm
Panel cutout: 90,5 x 45 mm

OPERATING CONDITIONS

Connection: connector terminal board, section < 1,5/2,5 mm²
Stabilization period: within 15 minutes after switch-on
Working temperature: -20°...60°C
Storage temperature: -20°...80°C
Cover: IP64 (front panel only)
El. safety: EN 61010-1, A2
Dielectric strength: 4 kVAC after 1 min between supply and input
 4 kVAC after 1 min between supply and data/analog output
 4 kVAC after 1 min between supply and relay output
 2,5 kVAC after 1 min between input and data/analog output
Insulation resistance: for pollution degree II, measuring cat. III.
 Power supply > 670 V (Z1), 300 V (D1)
 Input, output, Exc. > 300 V (Z1), 160 V (D1)
EMC: EN 61326-1
Seismic capacity: IEC 980: 1993, par. 6
SW validation: Class B, C in compliance with IEC 62138, 61226

PI - Primary insulation, DI - Double insulation

MEASURING RANGES

OMB 402 is a multifunction instrument available in following types and ranges

type UNI, standard [code „0“]

DC: ±60/±160/±300/±1 200 mV
PM: 0...5/20 mA/4...20 mA; ±2/±5/±10/±40 V
OHM: 0...100 Q/0...1/10/100 kQ/Auto
RTD: Pt 50/100/500/1 000
Cu: Cu 50/100
Ni: Ni 1 000/10 000
T/C: J/K/T/E/B/S/R/N/L
DU: Linear potentiometer (min. 500 Q)

type UNI, Option A

DC: ±0,1/±0,25/±0,5/±2/±5 A; ±100/±250/±500 V

CONNECTING INDIVIDUAL INPUTS

	INPUT „I“	INPUT „U“
DC		±60/±160/±300/±1200 mV
PM	0...5/0...20 mA/4...20 mA	±2/±5/±10/40 V

ORDER CODE SPECIFICATION

	UNI	
W/D	standard	
A	±0,1/±0,25/±0,5/±2/±5 A ±100/±250/±500 V	
B	Expansion about three inputs (PM)	
C		
K		
P		
S		
U		
Z	on request	

CONNECTION

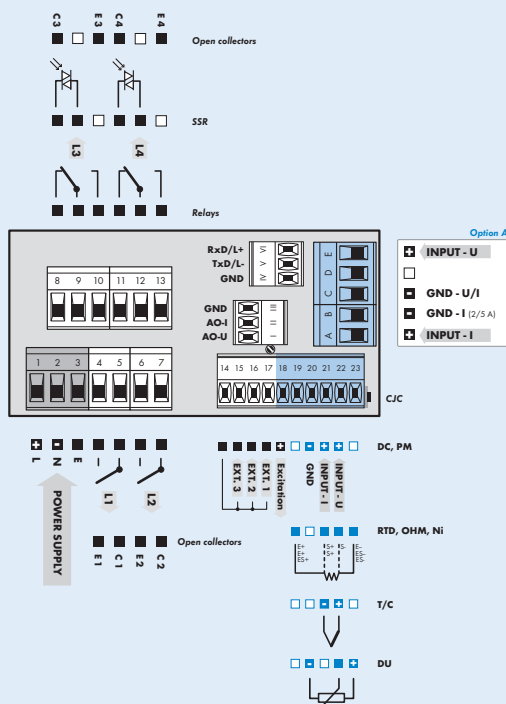

*GND (input + Option A) is galvanically connected with inputs EXT. and the OM Link connector
 *In case of Option B we recommend to connect terminals GND (main board/additional board) by external connection

ORDER CODE

OMB 402UNI - **1** -

Power supply	10...30 V AC/DC 80...250 V AC/DC	0 1					
Option, see table „Order code specification“		?					
Comparators	none 1x relay (Form A) 2x relays (Form A) 3x relays [2x Form A + 1x Form C] 4x relays [2x Form A + 2x Form C] 2x open collectors 4x open collectors 2x open collectors + 2x relays (Form C) 2x relays (Form C) 2x SSR 2x bistable relays 1x relay (Form C)	0 1 2 3 4 5 6 7 8 9 A B					
Analog output	no yes [Compensation < 600 Q/12 V] yes [Compensation < 1 000 Q/24 V]	0 1 2					
Data output	none RS 232 RS 485 MODBUS PROFIBUS	0 1 2 3 4					
Excitation	yes	1					
Data record	no RTC FAST (only for UNI)	0 1 2					
Colour of digital display	red green	1 2					
Other	customer version, do not fill in SW validation - IEC 62138, IEC 61226					00 VS	

Default execution is shown in bold

* Launch for sale has not been set



- BARGRAPH - 50 LED WITH DISPLAY AND LCD SCALE
- MULTIFUNCTION INPUT (DC, PM, RTD, T/C, DU)
- DIGITAL FILTERS, TARE, LINEARIZATION
- SIZE OF DIN 160 x 60 MM
- POWER SUPPLY 80...250 V AC/DC
- Option
Comparators • Data output • Analog output • Data record
Power supply 10...30 V AC/DC

OPERATION

The instrument is set and controlled by two control keys and a turn knob located on the front panel. All programmable settings of the instrument are implemented in three setting modes.

LIGHT MENU is protected by optional number code and contains solely items necessary for instrument setting

PROFI MENU is protected by optional number code and contains complete instrument setting

USER MENU may contain arbitrary items from the programming menu (LIGHT/PROFI), which determine the right (see, change). Access w/o password.

Standard equipment is the OM Link interface, which together with operation program enables modification and filing of all instrument settings as well as perform firmware updates (with OML cable). The program is also designed for visualization and filing of measured values from more instruments.

All settings are stored in the EEPROM memory (they hold even after the instrument is switched off).

OPTION

COMPARATORS are assigned to monitor one, two, three or four limit values with relay output. The user may select limits regime: LIMIT/DOSING/FROM-TO. The limits have adjustable hysteresis within the full range of the display as well as selectable delay of the switch-on in the range of 0...99,9 s. Reaching the preset limits is signalled by LED and simultaneously by the switch-on of the relevant relay.

DATA OUTPUTS are for their rate and accuracy suitable for transmission of the measured data for further projection or directly into the control systems. We offer an isolated RS232 and RS485 with the ASCII/MESSBUS/MODBUS/PROFIBUS protocol.

ANALOG OUTPUTS will find their place in applications where further evaluating or processing of measured data is required in external devices. We offer universal analog output with the option of selection of the type of output - voltage/current. The value of analog output corresponds with the displayed data and its type and range are selectable in menu.

MEASURED DATA RECORD is an internal time control of data collection. It is suitable where it is necessary to register measured values. Two modes may be used. FAST is designed for fast storage (40 records/s) of all measured values up to 8 000 records. Second mode is RTC, where data record is governed by Real Time with data storage in a selected time segment and cycle. Up to 266 000 values may be stored in the instrument memory. Data transmission into PC via serial interface RS232/485 and OM Link.

OMB 451

OMLINK

The OMB 451 model series are programmable, three-color panel bargraphs with auxiliary display and adjustable LCD scale. The instruments are designed as dimensional replacement of the ZEPAKOMP instruments.

Type OMB 451UNI is a multifunction instrument with the option of configuration for 8 different types of input, easily configurable in the instrument menu.

The instrument is based on an 8-bit microcontroller with multi-channel 24-bit sigma-delta converter, which secures high accuracy, stability and easy operation of the instrument.

OMB 451UNI

DC VOLTMETER AND AMMETER

PROCESS MONITOR

OHMMETER

THERMOMETER FOR PT/CU/NI/THERMOCOUPLES

DISPLAY UNIT FOR LINEAR POTENTIOMETERS

STANDARD FUNCTIONS

PROGRAMMABLE PROJECTION

Selection: of input type and measuring range

Measuring range: adjustable as fixed or with automatic change (OHM)

Scale: LCD, freely programmable

Setting: manual, in menu optional projection on the display may be set for both limit values of the input signal

Projection: 50 LED + 6-digit auxiliary display

COMPENSATION

Of conduct (RTD, OHM): automatic (3- and 4-wire) or manual in menu (2-wire)

of conduct in probe (RTD): internal connection (conduct resistance in measuring head)

of CJC (T/C): manual or automatic, in menu it is possible to perform selection of the type of thermocouple and compensation of cold junctions, which is adjustable or automatic

LINEARIZATION

Linearization (DC, PM, DU): through linear interpolation in 50 points (solely via OM Link)

DIGITAL FILTERS

Floating/Exp./Arithmetic average: from 2...30/100/100 measurements

Rounding: setting the projection step for display

EXCITATION

Range: 5...24 VDC, for feeding of sensors and transmitters

MATHEMATIC FUNCTIONS

Min/max. value: registration of min/max. value reached during measurement

Tare: designed to reset display upon non-zero input signal

Peak value: the display shows only max. or min. value

Mat. operations: polynome, 1/x, logarithm, exponential, power, root, sin x and at the same time between inputs - sum, difference, product, quotient

EXTERNAL CONTROL

Lock: control keys blocking

Hold: display/instrument blocking

Tare: tare activation

Resetting MM: resetting min/max value

TECHNICAL DATA

PROJECTION

Display: 50 three-color LED + three-color LED for indication of the limits, 6-digit auxiliary display [-99999...999999], digit height 9,1mm illuminated and freely programmable LCD scale
Decimal point: setting - in menu
Brightness: setting - in menu

INSTRUMENT ACCURACY

TK: 50 ppm/°C
Accuracy: ±0,1% of range + 1 digit [for projection 9999 and 5 meas./s] ±0,15% of range + 1 digit **RTD, T/C**
Accuracy of cold junction measurement: ±1,5°C
Rate: 0,1...40 meas./s
Overload capacity: 2x; 10x (t < 30 ms) - not for > 250 V and 5 A
Linearization: by linear interpolation in 50 points
Digital filters: Exp./Floating/Arithmetic average, Rounding
Functions: Min/max. value., Tare, Peak value, Mat. operations
Ext. control: HOLD, LOCK, Tare, Reset
Data record: measured data record into instrument memory
RTC: 15 ppm/°C, time-date-display value, < 265k data
FAST [UNI] - display value, < 8k data
Watch-dog: reset after 0,4 s
OM Link: Company communication interface for operation, setting and update of instruments
Calibration: at 25°C and 40% r.h.

COMPARATOR

Type: digital, setting in menu, contact switch < 30 ms
Limits: - 99999...999999
Hysteresis: 0...999999
Delay: 0...99,9 s
Output: 1...4x relays Form A (250 VAC/50 VDC, 3 A), 2x/4x open collector

DATA OUTPUT

Protocol: ASCII, MESSBUS, MODBUS - RTU, PROFIBUS
Data format: 8 bit + no parity + 1 stop bit (ASCII)
 7 bit + even parity + 1 stop bit (Messbus)
Rate: 600...230 400 Baud
 9 600 Baud...12 Mbaud (PROFIBUS)
RS 232: isolated
RS 485: isolated, addressing (max. 31 instruments)

ANALOG OUTPUT

Type: isolated, programmable with 16-bit D/A converter, type and range are selectable in programming mode
Non-linearity: 0,1% of range
TK: 15 ppm/°C
Rate: response to change of value < 1 ms
Ranges: 0...2/5/10 V, ±10 V, 0...5 mA, 0/4...20 mA [comp. < 600 Ω/12 V or 1 000 Ω/24 V]

EXCITATION

Adjustable: 5...24 VDC/max. 12 W

POWER SUPPLY

10...30 V AC/DC, ±10%, max. 13,5 VA, PF≥0,4, I_{STB}< 40 A/1 ms
 80...250 V AC/DC, ±10%, max. 13,5 VA, PF≥0,4, I_{STB}< 40 A/1 ms
 Power supply is protected by a fuse inside the instrument

MECHANIC PROPERTIES

Material: Noryl GFN2 SE1, incombustible UL 94 V-1
Dimensions: 160 x 60 x 80 mm
Panel cutout: 150 x 50 mm

OPERATING CONDITIONS

Connection: connector terminal board, section < 1,5/2,5 mm²
Stabilization period: within 15 minutes after switch-on
Working temperature: -20°...60°C
Storage temperature: -20°...80°C
Cover: IP64 (front panel only)
El. safety: EN 61010-1, A2
Dielectric strength: 4 kVAC after 1 min between supply and input
 4 kVAC after 1 min between supply and data/analog output
 4 kVAC after 1 min between supply and relay output
 2,5 kVAC after 1 min between input and data/analog output
Insulation resistance: for pollution degree II, measuring cat. III.
 Power supply > 670 V (Z1), 300 V (D1)
 input, output, Exc. > 300 V (Z1), 150 V (D1)
EMC: EN 61326-1
Seismic capacity: IEC 980: 1993, par. 6
SW validation: Class B, C in compliance with IEC 62138, 61226

PI - Primary insulation, DI - Double insulation

MEASURING RANGES

OMB 451 is a multifunction instrument available in following types and ranges

type UNI, standard [code „0”]

DC: ±60/±150/±300/±1 200 mV
PM: 0...5/20 mA/4...20 mA; ±2/±5/±10/±40 V
OHM: 0...100 Ω/...1/10/100 kΩ/Auto
RTD: Pt 50/100/500/1 000
Cu: Cu 50/100
Ni: Ni 1 000/10 000
T/C: J/K/T/E/B/S/R/N/L
DU: Linear potentiometer (min. 500 Ω)

type UNI, Option A

DC: ±0,1/±0,25/±0,5/±2/±5 A; ±100/±250/±500 V

CONNECTING INDIVIDUAL INPUTS

	INPUT „I”	INPUT „U”
DC		±60/±150/±300/±1200 mV
PM	0...5/0...20 mA/4...20 mA	±2/±5/±10/40 V

ORDER CODE SPECIFICATION

	UNI
W/D	standard
A	±0,1/±0,25/±0,5/±2/±5 A ±100/±250/±500 V
B	Expansion about three inputs (PM)
C	
K	
P	
S	
U	
Z	on request

CONNECTION

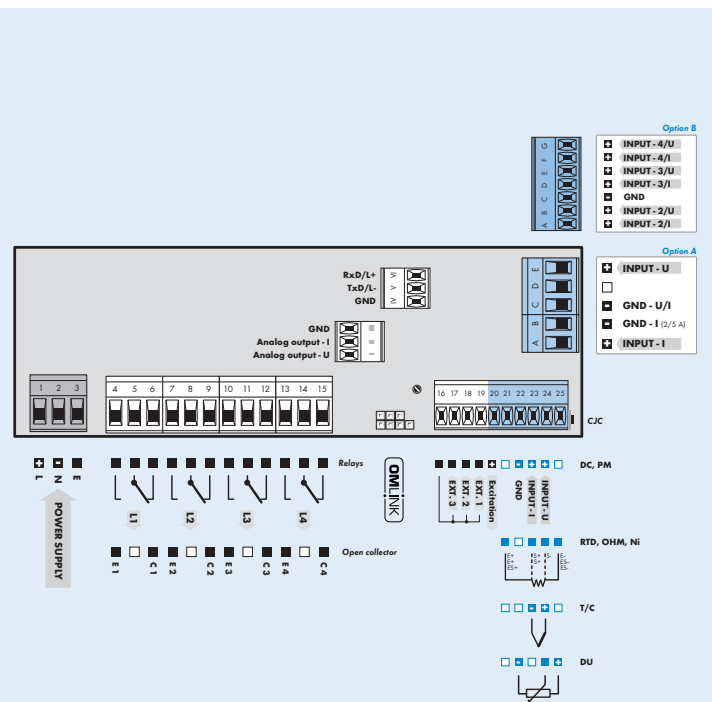

ORDER CODE

OMB 451UNI

□□□□ - □□□□□□ **1** □□□□ - □□

Power supply	10...30 V AC/DC 80...250 V AC/DC	0 1							
Option, see table „Order code specification”		?							
Comparators	none 1x relay (Form C) 2x relays (Form C) 3x relays (Form C) 4x relays (Form C) 2x open collectors 4x open collectors 2x open collectors + 2x relays (Form C)	0 1 2 3 4 5 6 7							
Analog output	no yes [Compensation < 600 Ω/12 V] yes [Compensation < 1 000 Ω/24 V]	0 1 2							
Data output	none RS 232 RS 485 MODBUS PROFIBUS	0 1 2 3 4							
Excitation	yes		1						
Data record	no RTC FAST (only for UNI)	0 1 2							
Colour of digital display	red green						1 2		
Other	customer version, do not fill in SW validation - IEC 62138, IEC 61226							00 VS	

Default execution is shown in bold

* Launch for sale has not been set

*GND (input + Option A) is galvanically connected with inputs EXT. and the OM Link connector
 *In case of Option B we recommend to connect terminals GND (main board/additional board) by external connection



OMB 452

The OMB 452 model series are programmable, three-color panel bargraphs with auxiliary display and adjustable LCD scale. The instruments are designed as dimensional replacement of the ZEPAKOMP instruments.

Type OMB 452LUNI is a multifunction instrument with the option of configuration for 8 different types of input, easily configurable in the instrument menu.

The instrument is based on an 8-bit microcontroller with multi-channel 24-bit sigma-delta converter, which secures high accuracy, stability and easy operation of the instrument.



- BARGRAPH - 50 LED WITH DISPLAY AND LCD SCALE
- MULTIFUNCTION INPUT (DC, PM, RTD, T/C, DU)
- DIGITAL FILTERS, TARE, LINEARIZATION
- SIZE OF DIN 160 x 80 MM
- POWER SUPPLY 80...250 V AC/DC
- Option
Comparators • Data output • Analog output • Data record
Power supply 10...30 V AC/DC

OMB 452LUNI

DC VOLTMETER AND AMMETER
PROCESS MONITOR
OHMMETER
THERMOMETER FOR PT/CU/NI/THERMOCOUPLES
DISPLAY UNIT FOR LINEAR POTENTIOMETERS

OPERATION

The instrument is set and controlled by two control keys and a turn knob located on the front panel. All programmable settings of the instrument are implemented in three setting modes.

LIGHT MENU is protected by optional number code and contains solely items necessary for instrument setting

PROFI MENU is protected by optional number code and contains complete instrument setting

USER MENU may contain arbitrary items from the programming menu (LIGHT/PROFI), which determine the right (see, change). Access w/o password.

Standard equipment is the OM Link interface, which together with operation program enables modification and filing of all instrument settings as well as perform firmware updates (with OML cable). The program is also designed for visualization and filing of measured values from more instruments.

All settings are stored in the EEPROM memory (they hold even after the instrument is switched off).

OPTION

COMPARATORS are assigned to monitor one, two, three or four limit values with relay output. The user may select limits regime: LIMIT/DOSING/FROM-TO. The limits have adjustable hysteresis within the full range of the display as well as selectable delay of the switch-on in the range of 0...99,9 s. Reaching the preset limits is signalled by LED and simultaneously by the switch-on of the relevant relay.

DATA OUTPUTS are for their rate and accuracy suitable for transmission of the measured data for further projection or directly into the control systems. We offer an isolated RS232 and RS485 with the ASCII/MESSBUS/MODBUS/PROFIBUS protocol.

ANALOG OUTPUTS will find their place in applications where further evaluating or processing of measured data is required in external devices. We offer universal analog output with the option of selection of the type of output - voltage/current. The value of analog output corresponds with the displayed data and its type and range are selectable in menu.

MEASURED DATA RECORD is an internal time control of data collection. It is suitable where it is necessary to register measured values. Two modes may be used. FAST is designed for fast storage (40 records/s) of all measured values up to 8 000 records. Second mode is RTC, where data record is governed by Real Time with data storage in a selected time segment and cycle. Up to 266 000 values may be stored in the instrument memory. Data transmission into PC via serial interface RS232/485 and OM Link.

STANDARD FUNCTIONS

PROGRAMMABLE PROJECTION

Selection: of input type and measuring range

Measuring range: adjustable as fixed or with automatic change (OHM)

Scale: LCD, freely programmable

Setting: manual, in menu optional projection on the display may be set for both limit values of the input signal

Projection: 50 LED + 6-digit auxiliary display

COMPENSATION

Of conduct (RTD, OHM): automatic (3- and 4-wire) or manual in menu (2-wire)

of conduct in probe (RTD): internal connection (conduct resistance in measuring head)

of CJC (T/C): manual or automatic, in menu it is possible to perform selection of the type of thermocouple and compensation of cold junctions, which is adjustable or automatic

LINEARIZATION

Linearization (DC, PM, DU): through linear interpolation in 50 points (solely via OM Link)

DIGITAL FILTERS

Floating/Exp./Arithmetic average: from 2...30/100/100 measurements

Rounding: setting the projection step for display

EXCITATION

Range: 5...24 VDC, for feeding of sensors and transmitters

MATHEMATIC FUNCTIONS

Min/max. value: registration of min/max. value reached during measurement

Tare: designed to reset display upon non-zero input signal

Peak value: the display shows only max. or min. value

Mat. operations: polynome, 1/x, logarithm, exponential, power, root, sin x and at the same time between inputs - sum, difference, product, quotient

EXTERNAL CONTROL

Lock: control keys blocking

Hold: display/instrument blocking

Tare: tare activation

Resetting MM: resetting min/max value

TECHNICAL DATA

PROJECTION

Display: 60 three-color LED + three-color LED for indication of the limits, 6-digit display [-999...9999+2 char.], 4x digit height 14 mm, 2x digit height 10 mm, illuminated and freely programmable LCD scale
Decimal point: setting - in menu
Brightness: setting - in menu

INSTRUMENT ACCURACY

TK: 50 ppm/°C
Accuracy: ±0,1% of range + 1 digit [for projection 9999 and 5 meas./s] ±0,15% of range + 1 digit **RTD, T/C**
Accuracy of cold junction measurement: ±1,5°C
Rate: 0,1..40 meas./s
Linearization: by linear interpolation in 50 points
Digital filters: Exp./Floating/Arithmetic average, Rounding
Functions: Offset, Min/max. value, Tare, Peak value, Mat. operations
Ext. control: HOLD, LOCK, Tare, Reset
Data record: measured data record into instrument memory
RTC: - 15 ppm/°C, time-date-display value, < 266k data
FAST [UNI] - display value, < 8k data
Watch-dog: reset after 0,4 s
OM Link: Company communication interface for operation, setting and update of instruments
Calibration: at 25°C and 40% r.h.

COMPARATOR

Type: digital, setting in menu, contact switch < 30 ms
Limits: -99999...999999
Hysteresis: 0...999999
Delay: 0...99,9 s
Output: 1..4x relays Form A [250 VDC/60 VDC, 3 A], 2x/4x open collector, 1..4x bistabil relays

DATA OUTPUT

Protocol: ASCII, MESSBUS, MODBUS - RTU, PROFIBUS
Data format: 8 bit + no parity + 1 stop bit [ASCII]
 7 bit + even parity + 1 stop bit [Messbus]
Rate: 600...230 400 Baud
 9 600 Baud...12 Mbaud [PROFIBUS]
RS 232: isolated
RS 485: isolated, addressing (max. 31 instruments)

ANALOG OUTPUT

Type: isolated, programmable with 16-bit D/A converter, type and range are selectable in programming mode
Non-linearity: 0.1% of range
TK: 15 ppm/°C
Rate: response to change of value < 1 ms
Ranges: 0...2/5/10 V, ±10 V, 0...5 mA, 0/4...20 mA [comp. < 600 Ω/12 V or 1 000 Ω/24 V]

EXCITATION

Adjustable: 5...24 VDC/max. 12 W

POWER SUPPLY

10...30 V AC/DC, ±10%, max. 13,5 VA, PF≥0,4, I_{STB} < 40 A/1 ms
 80...250 V AC/DC, ±10%, max. 13,5 VA, PF≥0,4, I_{STB} < 40 A/1 ms
 Power supply is protected by a fuse inside the instrument

MECHANIC PROPERTIES

Material: Noryl GFN2 SE1, incombustible UL 94 V-1
Dimensions: 160 x 80 x 80 mm
Panel cutout: 150 x 70 mm

OPERATING CONDITIONS

Connection: connector terminal board, section < 1,5/2,5 mm²
Stabilization period: within 15 minutes after switch-on
Working temperature: -20°...60°C
Storage temperature: -20°...80°C
Cover: IP64 (front panel only)
El. safety: EN 61010-1, A2
Dielectric strength: 4 kVAC after 1 min between supply and input
 4 kVAC after 1 min between supply and data/analog output
 4 kVAC after 1 min between supply and relay output
 2,5 kVAC after 1 min between input and data/analog output
Insulation resistance: for pollution degree II, measuring cat. III.
 Power supply > 670 V [Z], 300 V [D]
 input, output, Exc. > 300 V [Z], 150 V [D]
EMC: EN 61326-1
Seismic capacity: IEC 980: 1993, par. 6
SW validation: class B, C in compliance with IEC 62139, 61226

PI - Primary insulation, DI - Double insulation

MEASURING RANGES

OMB 452 is a multifunction instrument available in following types and ranges

type UNI, standard [code „0"]

DC: ±60/±150/±300/±1 200 mV
PM: 0...5/20 mA/4...20 mA; ±2/±5/±10/±40 V
DHM: 0...100 Ω/0...1/10/100 kΩ/Auto
RTD: Pt 50/100/500/1 000
Cu: Cu 50/100
Ni: Ni 1 000/10 000
T/C: J/K/T/E/B/S/R/N/L
DU: Linear potentiometer (min. 500 Ω)

type UNI, Option A

DC: ±0,1/±0,25/±0,5/±2/±5 A; ±100/±250/±500 V

CONNECTING INDIVIDUAL INPUTS

	INPUT „I“	INPUT „U“
DC		±60/±150/±300/±1200 mV
PM	0...5/0...20 mA/4...20 mA	±2/±5/±10/40 V

ORDER CODE SPECIFICATION

	UNI
W/D	standard
A	±0,1/±0,25/±0,5/±2/±5 A ±100/±250/±500 V
B	Expansion about three inputs (PM)
C	
K	
P	
S	
U	
Z	on request

CONNECTION

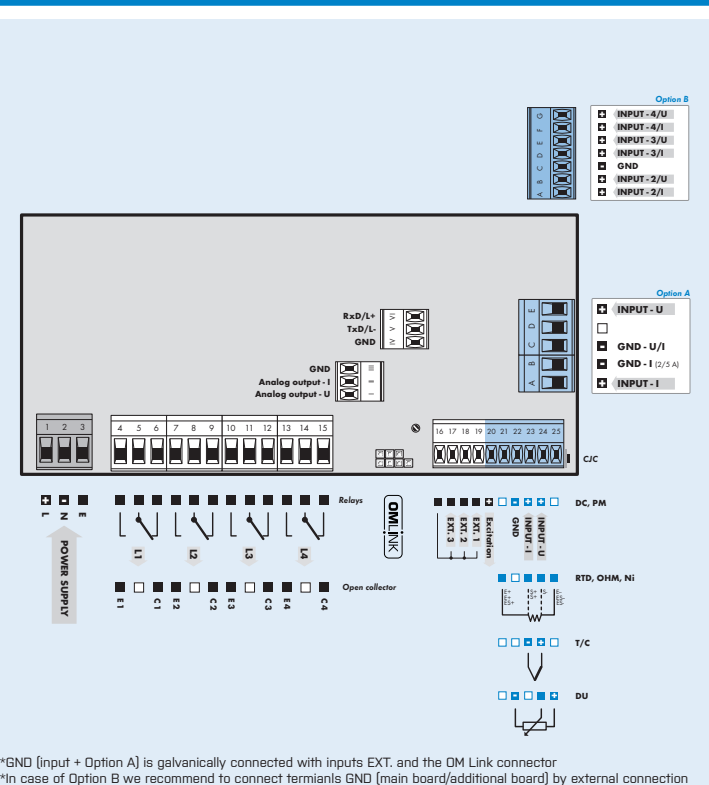

ORDER CODE

OMB 452																				
Power supply	10...30 V AC/DC	0																		
	80...250 V AC/DC	1																		
Option, see table „Order code specification“			?																	
Comparators	none				0															
	1x relay [Form C]				1															
	2x relays [Form C]				2															
	3x relays [Form C]				3															
	4x relays [Form C]				4															
	2x open collectors				5															
	4x open collectors				6															
	2x open collectors + 2x relays [Form C]				7															
Analog output	no				0															
	yes [Compensation < 600 Ω/12 V]				1															
	yes [Compensation < 1 000 Ω/24 V]				2															
Data output	none				0															
	RS 232				1															
	RS 485				2															
	MODBUS				3															
	PROFIBUS				4															
Excitation	yes								1											
Data record	no																		0	
	RTC																			1
	FAST [only for UNI]																			2
Colour of digital display	red																			1
	green																			2
Other	customer version, do not fill in																			00
	SW validation - IEC 62138, IEC 61226																			VS

Default execution is shown in bold

* Launch for sale has not been set

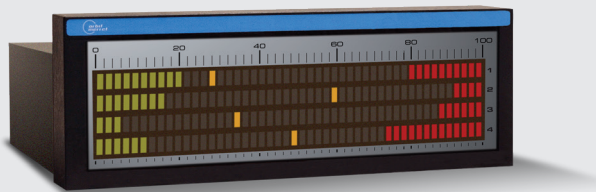

OMB 481/483/484

OMLINK

The OMB 480 model series are panel programmable 3-color bargraphs.

The instruments are designed as 100% substitutes for (the trace of EDU light or EDU light trace), devices of Russian production M1730, M1731 > OMB 481, M1741 > OMB 483 and M1743 > OMB 484.

The light trace consists of 48 tri-color LEDs. One yellow LED signalizes the measured value and the measuring range is delimited by a slightly illuminated band (border limits), where lower limit is green and upper limit red. Upon exceeding the set range (within the border limits) the yellow LED changes to green or red according to its value.

Green arrow signalizes input range underflow; red arrow signalizes its overflow. The arrows are located outside the light trace. Upon underflow the light trace switches off. Both arrows being switched on simultaneously indicate circuit opening.

The instrument is based on an 8-bit microcontroller with A/D converter, which secures high accuracy, stability and easy operation of the instrument.

- THREE-COLOR BARGRAPH 48 LED
- MULTIFUNCTION INPUT (DC, PM, T/C)
- DIGITAL FILTERS, TARE, LINEARIZATION
- SIZE OF DIN 160 X 30/60 MM
- POWER SUPPLY 10...30 V AC/DC
- Option
Comparators

OMB 481/483/484

DC VOLTMETER AND AMMETER
PROCESS MONITOR
THERMOMETER FOR THERMOCOUPLES

OPERATION

The instrument is designed for simple measurement without further evaluation.

Standard equipment is the OM Link interface, which along with the operating program allows for editing and archiving all of the instrument settings as well as to perform firmware update (with OML cable). Upon compliance with technical requirements instrument calibration is also feasible through the OM Link program.

All settings are stored in the EEPROM memory (they hold even after the instrument is switched off).

OPTION

COMPARATORS are assigned to monitor two limit values with relay output. The limits have adjustable hysteresis within the full range of the display as well as selectable delay of the switch-on in the range of 0...99,9 s. Reaching the preset limits is signalled by LED and simultaneously by the switch-on of the relevant relay.

STANDARD FUNCTIONS

PROGRAMMABLE PROJECTION

Selection: of input type and measuring range

Setting: manual, in menu optional projection on the display may be set for both limit values of the input signal

Projection: 48 LED

LINEARIZATION

Linearization: through linear interpolation in 25 points (solely via OM Link)

DIGITAL FILTERS

Exponential average: from 2...100 measurements

Rounding: setting the projection step for display

Insensitivity zone: it is entered directly in measuring units and is symmetrical on both sides

EXTERNAL CONTROL

Hold: display/instrument blocking

TECHNICAL DATA

PROJECTION

Display: three-color LED (red/green/orange)
OMB 481 - 1x 48 tri-color LEDs
OMB 483 - 3x 48 tri-color LEDs
OMB 484 - 4x 48 tri-color LEDs
Colors: red/green/orange
Brightness: setting - in menu

INSTRUMENT ACCURACY

TK: 50 ppm/°C
Accuracy: ±1% of range + 1 digit
Rate: 0,5/5/50/max. meas./s
Overload capacity: 2x; 10x (t < 30 ms)
Linearization: by linear interpolation in 25 points (solely via OM Link)
Digital filters: exponential average, rounding, insensitivity zone
Watch/dog: reset after 20ms
Measuring test: control of measuring range from external calibrator
OM Link: Company communication interface for instrument operation, configuration and update
Calibration: at 25°C and 40% relative humidity

COMPARATOR

Type: digital, setting in menu, contact switch-on < 30 ms
Limits: within full range
Hysteresis: positive values
Delay: 0...99,9 s
Output: 2x relay with switching contact [250 VAC/30VDC, 3A]

EXCITATION

Fixed: 24 VDC/max. 1,2 W

POWER SUPPLY

10...30 V DC/24 VAC, ±10%, 10 VA, PF ≥ 0,4, I_{STP} < 45 A/1,1 ms
Power supply is protected by a fuse inside the instrument

MECHANIC PROPERTIES

Material: Fe/ABS, incombustible UL 94 V-1, black
Dimensions:
 OMB 481 164 x 30 x 65 mm
 OMB 483 164 x 60 x 65 mm
 OMB 484 164 x 60 x 65 mm
Panel cutout:
 OMB 481 157 x 30 mm
 OMB 483 157 x 49 mm
 OMB 484 157 x 49 mm

OPERATING CONDITIONS

Connection: connector terminal board, section < 2,5 mm²
Stabilization period: within 15 minutes after switch-on
Working temperature: -20°...60°C
Storage temperature: -20°...85°C
Cover: IP42 (front panel only)
Electrical safety: EN 61010-1, A2
Insulation resistance: for pollution degree II, measuring category III, power supply > 670 V [Z1] 300 V [D], input, output > 300 V [Z1], 250 V [D]
EMC: EN 61326-1
EN 550222, A1, A2
Seismic capacity: IEC 980: 1993, par. 6
Software validation: rated class B, C in compliance with IEC 62138

PI - Primary insulation, DI - Double insulation

MEASURING RANGES

OMB 481/483/484 is a multifunction instrument available in following types and ranges

DC: 0...60 mV
PM: 0...5/20 mA, 4...20 mA; 0...10 V
T/C: E/J/K/N + GOST-R

CONNECTING INDIVIDUAL INPUTS

	INPUT 0-20 MA	INPUT 0-60 MV	INPUT 0-10 V
DC		0...60 mV	
PM	0...20/0...20 mA, 4...20 mA		0...10 V
T/C		E/J/K/N + GOST-R	

CONNECTION

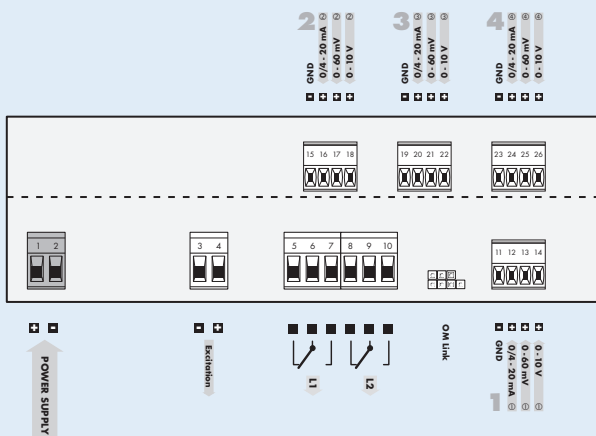

ORDER CODE

OMB	<input type="text"/>	-	<input type="text"/>	-	<input type="text"/>
Type	4 8 1	•	<input type="text"/>		
	4 8 2	•	<input type="text"/>		
	4 8 3	•	<input type="text"/>		
Comparators	no	0	<input type="text"/>		
	yes	1	<input type="text"/>		
Other	customer version, do not fill in				00
	SW validation - IEC 62138, IEC 61226				VS

Default execution is shown in bold



OM 402JEDU

OM 402JEDU is a 4-digit panel programmable instrument with 3-color column display panel.

The instruments are designed as 100% substitutes for devices of Russian production: KPD1 – 503/504/517/518, KPM1 – 503/504/546, KPP1 – 512 and KPU1 – 503/504/562/576.

The OM 402JEDU version is a multifunction instrument with configuration options for 7 different types of input, easily configurable in the instrument's menu.

Using tri-color displays with adjustable border of color-change positively affects both lucidity and simplicity of operation, as well as prompt and error-free resolution of contingent critical statuses in measuring processes.

The instrument consists of a tri-color column with signalization of relay outputs' status and a master (20 mm) display that both, based on set parameters, in addition also change color and thus provide the operating staff an immediate report on the measuring status.

Complementary information is provided on displays (green) with measuring units and adjustable limits of individual active relay outputs.

The instrument is based on a microcontroller with multi-channel 24-bit sigma-delta converter, which secures high accuracy and easy operation of the instrument.

OM 402JEDU

DC VOLTMETER AND AMMETER

PROCESS MONITOR

OHMMETER

THERMOMETER FOR PT/CU/Ni/TERMOCOUPLES

DISPLAY UNIT FOR LINEAR POTENTIOMETERS



- 4-DIGIT PROGRAMMABLE PROJECTION
- MULTIFUNCTION INPUT (DC, PM, RTD, T/C, DU)
- DIGITAL FILTERS, TARE, LINEARIZATION
- COMPARATORS, MEASURED DATA RECORD
- ANALOG OUTPUT, EXCITATION
- POWER SUPPLY 80...250 V AC/DC
- Option
Data output • Power supply 10...30 V AC/DC

OPERATION

The instrument is set and controlled by five control keys located on the front panel. All programmable settings of the instrument may be performed in three adjusting modes:

LIGHT MENU is protected by optional number code and contains solely items necessary for instrument setting

PROFI MENU is protected by optional number code and contains complete instrument setting

USER MENU may contain arbitrary items from the programming menu (LIGHT/PROFI), which determine the right (see, change). Access w/o password.

Standard equipment is the OM Link interface, which together with operation program enables modification and filing of all instrument settings as well as perform firmware updates (with OML cable). The program is also designed for visualization and filing of measured values from more instruments.

All settings are stored in the EEPROM memory (they hold even after the instrument is switched off).

OPTION

DATA OUTPUTS are for their rate and accuracy suitable for transmission of the measured data for further projection or directly into the control systems. We offer an isolated RS485 with the ASCII protocol.

STANDARD FUNCTIONS

PROGRAMMABLE PROJECTION

Selection: of input type and measuring range

Measuring range: adjustable as fixed or with automatic change (OHM)

Setting: manual, in menu optional projection on the display may be set for both limit

values of the input signal, e.g. input 0...39,99 V > 0...850.0

Projection: -999...9999

COMPENSATION

Of conduct (RTD, OHM): automatic (3- and 4-wire) or manual in menu (2-wire)

of conduct in probe (RTD): internal connection (conduct resistance in measuring head)

of CJC (T/C): manual or automatic, in menu it is possible to perform selection of the type of thermocouple and compensation of cold junctions, which is adjustable or automatic

LINEARIZATION

Linearization (DC, PM, DU): through linear interpolation in 50 points (solely via OM Link)

COMPARATORS

Output: 4x bi-stable relay with switching contact

ANALOG OUTPUT

Type: isolated, programmable with 16-bit D/A converter, type and range are selectable in programming mode 0...2/5/10 V, ±10 V, 0...5 mA, 0/4...20 mA

MEASURED DATA RECORD

RTC: 15 ppm/°C, time-date-display value, < 266k data

DIGITAL FILTERS

Floating/Exp./Arithmetic average: from 2...30/100/100 measurements

Rounding: setting the projection step for display

MATHEMATIC FUNCTIONS

Min/max. value: registration of min/max. value reached during measurement

Tare: designed to reset display upon non-zero input signal

Peak value: the display shows only max. or min. value

Mat. operations: polynome, 1/x, logarithm, exponential, power, root, sin x

EXTERNAL CONTROL

Lock: control keys blocking

Hold: display/instrument blocking

Tare: tare activation

Resetting MM: resetting min/max value

TECHNICAL DATA

PROJECTION

Display: 32 color LEDs with limits signalization, tri-color LED display, height 20mm, auxiliary green display for measuring units, auxiliary displays for limits projection, height 10mm
Colors: red/green/orange
Decimal point: setting - in menu
Brightness: setting - in menu

INSTRUMENT ACCURACY

TK: 50 ppm/°C
Accuracy: ±0,1% of range + 1 digit [for projection 9999 and 5 meas./s] ±0,15% of range + 1 digit **RTD, T/C**
Accuracy of cold junction measurement: ±1,5°C
Rate: 0,1...40 meas./s
Overload capacity: 2x; 10x (t < 30 ms)
Linearization: by linear interpolation in 50 points
Digital filters: Exp./Floating/Arithmetic average, Rounding
Functions: offset, Min/max value, Tare, Peak value, Mat. operations
Ext. control: HOLD, LOCK, Tare, Min/Max
Data record: measured data record into instrument memory
RTC - 15 ppm/°C, time-date display value, < 266k data
Resolution [RTD, T/C]: 1/0,1/0,01°C
Watch-dog: reset after 0,4 s
OM Link: Company communication interface for operation, setting and update of instruments
Calibration: at 25°C and 40% r.h.

COMPARATOR

Type: digital, setting in menu, contact switch < 30 ms
Limits: -9999...99999
Hysteresis: 0...999999
Delay: 0...99,9 s
Output: 4x bi-stable relay with switching contact, Form C (250 VAC/30 VDC, 3 A)

DATA OUTPUT

Protocol: ASCII
Data format: 8 bit + no parity + 1 stop bit [ASCII]
Rate: 600...230 400 Baud
RS 232: isolated
RS 485: isolated, addressing (max. 31 instruments)

ANALOG OUTPUT

Type: isolated, programmable with 16-bit D/A converter, type and range are selectable in programming mode
Non-linearity: 0,1% of range
TK: 15 ppm/°C
Rate: response to change of value < 1 ms
Ranges: 0...2/5/10 V, ±10 V, 0...5 mA, 0/4...20 mA (comp. < 1 000 Q/24 V)

EXCITATION

Adjustable: 5...24 VDC/max. 1,2 W

POWER SUPPLY

10...30 V AC/DC, ±10%, max. 13,5 VA, PF≥0,4, I_{STB}< 40 A/1 ms
 80...250 V AC/DC, ±10%, max. 13,5 VA, PF≥0,4, I_{STB}< 40 A/1 ms
 Power supply is protected by a fuse inside the instrument

MECHANIC PROPERTIES

Material: aluminum, gray RAL 9018
Dimensions: 153 x 193 x 88 mm
Panel cutout: 145 x 185 mm

OPERATING CONDITIONS

Connection: connector terminal board, section < 1,5/2,5 mm²
Working temperature: -20°...60°C
Storage temperature: -20°...80°C
Cover: IP64 [front panel only]
El. safety: EN 61010-1, A2
Dielectric strength: 4 kVAC after 1 min between supply and input
 4 kVAC after 1 min between supply and data/analog output
 4 kVAC after 1 min between supply and relay output
 2,5 kVAC after 1 min between input and data/analog output
Insulation resistance: for pollution degree II, measuring cat. III.
 Power supply > 670 V [Z], 300 V [D]
 input, output, Exc. > 300 V [Z], 150 V [D]
EMC: EN 61326-1
Seismic capacity: IEC 980: 1993, par. 6
SW validation: Class B, C in compliance with IEC 62138, 61226

PI - Primary insulation, DI - Double insulation

MEASURING RANGES

OMD 402JEDU is a multifunction instrument available in following types and ranges

DC: ±60/±150/±300/±1 200 mV
PM: 0...5/20 mA/4...20 mA; ±2/±5/±10/±40 V
OHM: 0...100 Q/0...1/10/100 kQ/Auto
RTD: Pt 50/100/500/1 000
Cu: Cu 50/100
Ni: Ni 1 000/10 000
T/C: J/K/T/E/B/S/R/N/L
DU: Linear potentiometer (min. 500 Q)

CONNECTING INDIVIDUAL INPUTS

	INPUT „I“	INPUT „U“
DC		±60/±150/±300/±1200 mV
PM	0...5/0...20 mA/4...20 mA	±2/±5/±10/40 V

CONNECTION

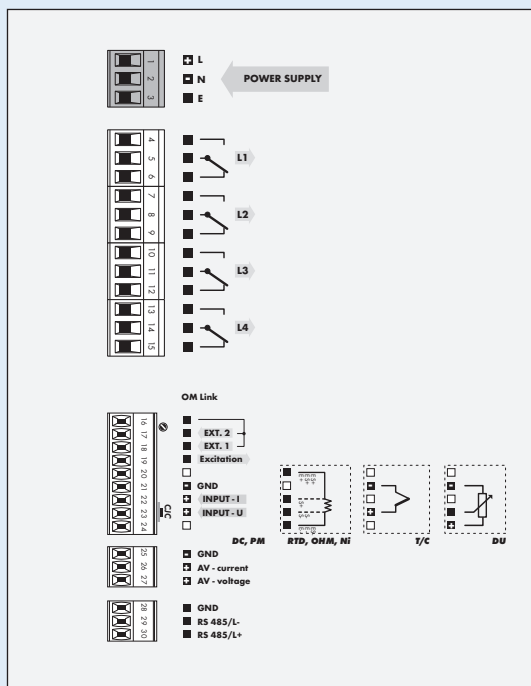

ORDER CODE

OM 402JEDU

Power supply 10...30 V AC/DC **0**
 80...250 V AC/DC **1**
Data output none **0**
 RS 485 **1**
Other customer version, do not fill in **00**
 SW validation - IEC 62138, IEC 61226 **VS**

Default execution is shown in bold



- PROGRAMMABLE ISOLATED TRANSMITTERS
- 2x MULTIFUNCTION INPUT (DC, PM, RTD, T/C, DU)
- LCD DISPLAY, DIGITAL FILTER, TARE
- 2x OUTPUT
0/4...20 mA/0...5 mA/0,2...2,2 kHz, 0...2/5/10 V/±10 V
- POWER SUPPLY 80...250 V AC/DC
- Option
Excitation • Comparators • Data output • Data record
Power supply 10...30 V AC/DC

OMX 102

OMLINK

The OMX 102 model range are DIN rail mountable programmable transmitters designed with the utmost versatility and user comfort in mind whilst keeping the cost at a favourable level. The OMX 102 various executions are UNI, DC, PWR, UQC and T. As a standard the instrument is fitted with a backlit LCD display which projects measured values and configuration settings.

OMX 102UNI is a multifunctional instrument with 8 possible input configurations easily adjustable in the instrument's menu.

OMX 102DC and OMX 102PWR are designed to measure extended AC and DC voltage and current.

The instrument is based on an 32-bit microcontroller with A/D converter, which ensures good accuracy, stability and easy operation of the instrument.

The OMX 102UQC type is a universal low-cost counter/frequencymeter/ stopwatch/timer.

OMX 102DC
DC VOLTMETER AND AMMETER

OMX 102PWR
AC VOLTMETER AND AMMETER
AC NETWORK ANALYSER

OMX 102UNI
DC VOLTMETER AND AMMETER
PROCESS MONITOR
OHMMETER
THERMOMETER FOR PT/CU/NI/TC
FOR LINEAR POTENTIOMETERS

OMX 102UQC
UNIVERSAL COUNTER

OMX 102T
TRANSMITTER FOR STRAIN GAUGE

OPERATION

The instrument is set and controlled by two control keys located on the front panel. All programmable settings of the instrument may be performed in three adjusting modes:

LIGHT MENU is protected by optional number code and contains solely items necessary for instrument setting

PROFI MENU is protected by optional number code and contains complete instrument setting

USER MENU may contain arbitrary items from the programming menu (LIGHT/PROFI), which determine the right (see, change). Access w/o password.

Standard equipment is the OM Link and USB interface, which together with operation program enables modification and filing of all instrument settings as well as perform firmware updates (with OML cable). The program is also designed for visualization and filing of measured values from more instruments

All settings are stored in the EEPROM memory (they hold even after the instrument is switched off).

The measured units may be projected on the display.

OPTION

EXCITATION is suitable for feeding of sensors and transmitters. It is isolated, with adjustable value in the range of 5/12/17/24 VDC.

COMPARATORS are assigned to monitor two limit values with relay output. The limits have adjustable hysteresis within the full range of the display as well as selectable delay of the switch-on in the range of 0...99,9 s. Reaching the preset limits is signalled by LED and simultaneously by the switch-on of the relevant relay.

DATA OUTPUTS are for their rate and accuracy suitable for transmission of the measured data for further projection or directly into the control systems. We offer an isolated RS232 and RS485 with the ASCII/PROFIBUS protocols, CAN and LAN.

STANDARD FUNCTIONS

PROGRAMMABLE INPUT

Selection: of input type and measuring range

Setting: manual, in menu it is possible to set for both limit values of the input signal arbitrary type (V, mA, Hz) and range of the analog output as well as projection on the LCD display

Weighing function (T): manual or automatic calibration, signalization of stabilized equilibrium, zero stabilization, aut. zero monitoring, defined number of segm. on the scale

Setting (UQC): measuring mode counter/frequency/timer/ counter for IRC/clock with adjustable calibration coefficient, time base and projection

ANALOG OUTPUT

Type: isolated, programmable with resolution of max. 16 bit, rate < 1 ms

Rozsah: 0...2/5/10 V, ±10 V, 0...5 mA, 0/4...20 mA, 0,2...2 200 Hz

COMPENSATION

Of conduct (RTD, OHM): automatic (3- and 4-wire) or manual in menu (2-wire)

of conduct in probe (RTD): internal connection (conduct resistance in measuring head) of CJC (T/C): manual or automatic, in menu it is possible to perform selection of the type of thermocouple and compensation of cold junctions, which is adjustable or automatic

LINEARIZATION

Linearization: through linear interpolation in 50 points (solely via OM Link)

DIGITAL FILTERS

Exponential average: from 2...100 measurements

Rounding: setting the projection step for display

Filtration constant (UQC): transmits input signal up to 10...1 000 Hz

FUNCTIONS

Preset (UQC): initial non-zero value, which is always read after resetting the instrument to zero

Setting current value (UQC): initial value, e.g. amount passed-through

Tare: designed to reset display upon non-zero input signal

EXTERNAL CONTROL

Hold: display/instrument blocking

Lock: control keys blocking

Resetting (UQC): counter resetting

Start/Stop (UQC): stopwatch/timer control

TECHNICAL DATA

PROJECTION

Display: LCD with backlighting, 2x 3 characters + 2x description (3 characters)

Description: second and fourth line of LCD display may be used for description of measured quantity, resp. output quantity v menu)

Decimal point: setting - in menu

INSTRUMENT ACCURACY

TK: 50 ppm/°C

Accuracy: ±0,15% of range + 1 digit (for 20 meas./s)

±0,3/±0,6/±0,9% of range + 1 digit

±0,05% of value + 1 digit

±0,01% of value ±2ms (UQC - stopwatch)

±0,01% of value ±130ms (UQC - RTC)

Accuracy of cold junction measurement: ±1,5°C

Rate: 0,5...160 meas./s, 0,6...5 meas./s for PWR

Overload capacity: 2x; 10x (t < 30 ms) - not for > 200 V and 5 A

Resolution: 0,1°C (RTD), 1°C (T/C), for display

Watch-dog: reset after 20 ms

Functions: HOLD, LOCK, Digital filters, Tare

Linearization (DC, PM, DU): by linear interpolation in 50 points

Functions (UQC): Data backup, Time backup, Present

Input filters (UQC): Filtration constant, Rounding

Time base (UQC): 0,5/1/5/10/50 s

Calibration constant (UQC): 0,01m...999M

Filtration constant (UQC): 0/5/40/100/1000 Hz

PRESET (UQC): 0,01m...999M

Measuring modes (PWR): voltage (V_{RMSE}), current (A_{RMSE}), real power (W),

frequency (Hz) and with calculation of Q, S, cos φ

Data record: measured data record into instrument memory

RTC - 15 ppm/°C, time-date-display value, < 266k data

PWR, T/C

UQC

UQC

UQC

FAST (UNI) - display value, < 8k data

OM Link: Company communication interface for operation, setting and update of instruments

Calibration: at 25°C and 40% rh.

COMPARATOR

Type: digital, setting in menu, contact switch-on < 50 ms

Limits: 999, resp. -99M...999M

Hysteresis: 0...999, resp. 999 k

Delay: 0...99,9 s

Output: 2x Form A relays (250 VAC/30 VDC, 3 A)

DATA OUTPUT

Protocol: ASCII, MESSBUS, MODBUS - RTU, PROFIBUS

Data format: 8 bit + no parity + 1 stop bit (ASCII)

7 bit + even parity + 1 stop bit (Messbus)

Rate: 600...230 400 Baud

9 600 Baud...12 Mbaud (PROFIBUS), 1 Mbaud (CAN)

RS 232/RS 485: isolated, addressable (max. 31 instruments/RS485)

Ethernet: 10/100BaseT, Security Protocols, POP3, ftp, http

ANALOG OUTPUT

Type: isolated, dual programmable with 16-bit D/A converter, type and range are selectable in programming mode

Non-linearity: 0,1% of range

TK: 15 ppm/°C

Rate: response to change of value < 1 ms

Ranges: 0...2/5/10 V, ±10 V, 0...5 mA, 0/4...20 mA

[comp. < 600 Q/12 V]

Frequency: isolated, programmable, open collector with inside power resistor, 0,2...2 200 Hz

EXCITATION

Adjustable: 5/12/17/24 VDC/max. 2,5 W, isolated

POWER SUPPLY

10...30 V AC/DC, ±10%, max. 13,5 VA, PF ≥ 0,4, I_{grm} < 40 A/1 ms

80...250 V AC/DC, ±10%, max. 13,5 VA, PF ≥ 0,4, I_{grm} < 40 A/1 ms

Power supply is protected by a fuse inside the instrument

MECHANIC PROPERTIES

Material: PA 66, incombustible UL 94 V-1, blue

Dimensions: 113 x 98 x 35 mm

Installation: to DIN rail 35 mm wide

OPERATING CONDITIONS

Connection: connector terminal board, section < 1,5/2,5 mm²

Stabilization period: within 15 minutes after switch-on

Working temperature: -20°...60°C

Storage temperature: -20°...80°C

Cover: IP20

Construction: safety class I

El. safety: EN 61010-1, A2

Dielectric strength: 4 kVAC after 1 min between supply and inputs

4 kVAC after 1 min between supply and data/anal. outputs

4 kVAC after 1 min between input and relays

3,75 kVAC after 1 min between input and data/anal. outputs

3,75 kVAC after 1 min between inputs

Insulation resistance: for pollution degree II, measuring cat. III.

Power supply, input, output, Exc. > 600 V (Z), 300 V (D)

EMC: EN 61326-1

Seismic capacity: IEC 950:1993, par. 6

SW validation (UNI): class B, C in compliance with IEC 62138, 61226

PI - Primary insulation, DI - Double insulation

MEASURING RANGES

OMX 102 is a multifunction instrument available in following types and ranges

type UNI (Channel 1 and 2)

DC: ±30/±60/1000 mV; ±20/±40/±80 V; ±90/±180 mA

PM: ±5/±20 mA/4...20 mA; ±2/±5/±10 V

OHM: 0...100/300 Q/0...1,5/3/24/30 kQ

RTD: Pt 50/100/500/1 000

Cu: Cu 50/100

Ni: Ni 1 000/10 000

T/C: J/K/T/E/B/S/R/N/L

DU: Linear potentiometer (min. 500 Q)

Type DC - Hi: ±1/±5 A; ±25/±50/±100/±200/±400 V (Channel 1)

Type PWR: 0...1/5 A,

0...60/300 mV; 0...10/120/250/450 V (Channel 1)

Type T: 1...4/2...8/4...16 mV/V (Channel 1)

Type UQC: 0...30/300 V, (Channel 1/12/17/274)

comparison levels are adjustable in the menu,

input frequency 0,1 Hz...500 kHz

CONNECTION

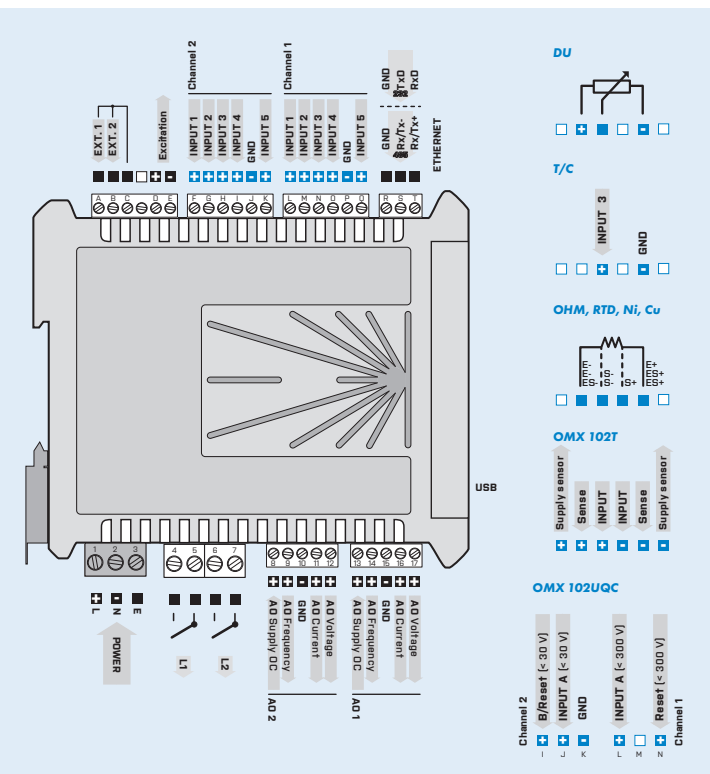

CONNECTING INDIVIDUAL INPUTS

	INPUT 1	INPUT 2	INPUT 3	INPUT 4	INPUT 5
DC	±20/±40/±80 V		±30/60 mV/±1 V		±90/180 mA
PM	±2/±5/±10 V				±5/20 mA, 4...20 mA
T/C			J/K/T/E/B/S/R/N/L		
DC/Hi	±25/±50/±100 V ±200/±400 V Channel 1				±1/±5 A Channel 2
PWR-I				0...60/300 mV Channel 2	0...1/5 A Channel 2
PWR-U	0...450 V Channel 1	0...250 V Channel 1	0...120 V Channel 1	0...10 V Channel 1	

ORDER CODE SPECIFICATION

UNI	
A	channel 1
B	channel 1 and 2

ORDER CODE

OMX 102	UNI	Channel 1	Channel 2	Channel 1	Channel 2
Type	U N I	•	•	•	•
	D C*	•	•	•	•
	P W R*	•	•	•	•
	U Q C*	•	•	•	•
	T*	•	•	•	•
Power supply	10...30 V AC/DC	0			
	80...250 V AC/DC	1			
Measuring range, see table „Order code specification“		?			
Comparators	no	0			
	1x relay [Form A]	1			
	2x relays [Form A]	2			
	1x open collector	3			
	2x open collectors	4			
Analog output	none	0			
	1x	1			
	2x	2			
	HART (not with data output)*	3			
Output	none	0			
	RS 232	1			
	RS 485 (ASCII, MESSBUS, MODBUS)	2			
	CAN*	3			
	PROFIBUS	4			
	10/100BaseT Ethernet*	7			
Excitation	no	0			
	Type OMX 102T always comes with excitation in standard	1			
Data record	no	0			
	RTC	1			
	FAST (only for UNI)	2			
Other	customer version, do not fill in				
	SW validation - IEC 62138, IEC 61226				00 VS

Default execution is shown in bold

* Launch for sale has not been set

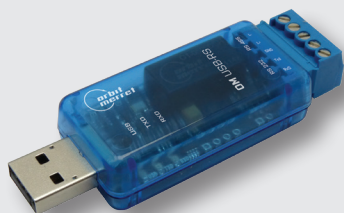

OM USB-RS II

Isolated transmitter USB > RS 232/RS 485

FUNCTIONS

Description: The transmitter provides galvanic separation of USB bus and RS output. Output lines RS 232 and RS 485 have galvanic connection and via exciters connected to one UART. Therefore it is possible to use always one output only.

DATA OUTPUT

Rate: RS 232: 600...460 800 baud

Rate: RS 485: 600...921 600 baud

POWER SUPPLY

5 V/100 mA from USB

OPERATING CONDITIONS

Connector terminal board: conductor section < 1,5 mm²

Working temperature: 0°...60 °C

Storage temperature: -10°...85 °C

Insulation capability: for pollution degree II, measuring category III

Input/output > 300 V(PI), 150 V(DI)



OM USB CABLE II

Galvanic isolated USB transducer for configuration of Orbit Merret instruments

FUNCTIONS

Description: Transducer provides galvanic separation between USB bus and an instrument. It is used for customised configuration of Orbit Merret instruments before initial installation. For transfer of measured data use please use dedicated data outputs (where available).

DATA OUTPUT

Rate: 600...230 400 baud

POWER SUPPLY

5 V/100 mA from USB

OPERATING CONDITIONS

Working temperature: 0°...60 °C

Storage temperature: -10°...85 °C

Insulation capability: for pollution degree II, measuring category III

Input/output > 300 V(PI), 150 V(DI)

ACCESSORY

OML cable for connecting to ORBIT MERRET instruments



OM USB ISO

USB isolator

FUNCTIONS

Description: Transducer provides galvanic separation from Full Speed USB bus with baud rate of 12 MBaud

POWER SUPPLY

5 V/250 mA from USB

OPERATING CONDITIONS

Output current: max. 200 mA

Working temperature: 0°...60 °C

Storage temperature: -10°...85 °C

Insulation capability: for pollution degree II, measuring category III

Input/output > 300 V(PI), 150 V(DI)

PI - Primary insulation, DI - Double insulation

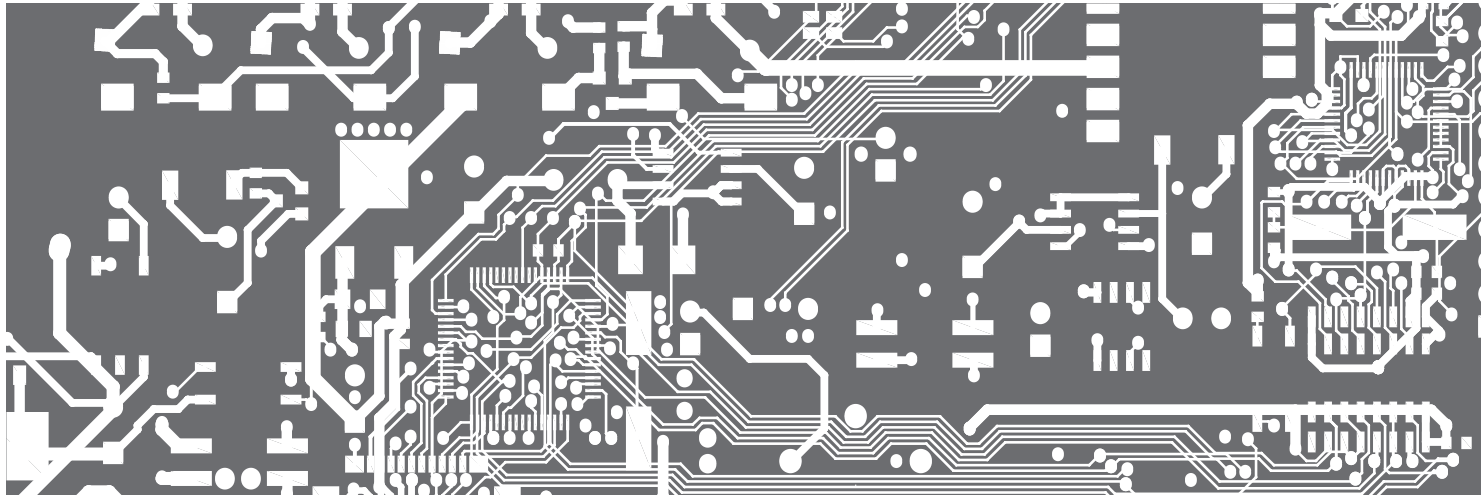
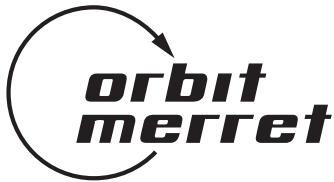

ORBIT MERRET, spol. s r. o.

Vodňanská 675/30
198 00 Prague 9
Czech Republic

phone: +420 281 040 200
fax: +420 281 040 299
e-mail: orbit@merret.eu

www.orbit.merret.eu

REPRESENTATIVE OFFICES:

Australia
Autech Control Group Pty Ltd
www.autechcontrol.com.au

Austria
GRUBER ELECTRIC GmbH
www.gruber-electric.at

Belgium
INELMATEC
www.inelmatec.be

Bosnia and Hercegovina
Instruments Ltd.
www.instruments.ba

Canada
A-Tech Instruments Ltd.
www.a-tech.ca

China
Shanghai Sibo M&E Co., Ltd.
www.sentop.com

Egypt
El-Gammal Industrial Systems Co.

Estonia
MTR Automation DU
www.mtr.ee

France
ADEL Instrumentation
www.adel-instrumentation.fr

Italy
ELAP spa
www.elap.it

Korea
Neuron Tech

Kuwait
KCC Engineering & Contracting Co.
www.kccecc.com.kw

Lithuania
AXIS Industries
www.axis.lt

Hungary
Q-TECH Engineering Ltd and Co.
www.q-tech.hu

Germany
VARIOHM- EUROSENSORS Ltd.
www.variohm.com

Netherlands
AE Sensors B.V.
www.aesensors.nl

Poland
TR Automatyka Sp.z o.o.
www.trautomatyka.pl

Portugal
Zeben – Sistemas Electrónicos Lda.
www.zeben.pt

Romania
Synchro Comp s.r.l.
www.synchro.ro

Romania
Synchro Comp s.r.l.
www.synchro.ro

Russia
OOO „ORBIT MERRET“
www.orbit.merret.ru

Slovakia
TECHREG, spol. s r. o.
www.techreg.sk

Slovenia
ADEPT PLUS d.o.o.
www.adeptplus.si

Sweden
Thermokon - Danelko
www.danelko.se

Switzerland
ORBIT CONTROLS AG
www.orbitcontrols.ch

Thailand
Lamax and Partners Co.,Ltd.
www.lamax.co.th

Tunisia
Compagnie Générale Du Matériel - CGM

Ukraine
PROMVITECH, SPF, LLC
www.promvitech.com.ua

USA
Metrix Instrument Co.& PMC/Beta
www.metrix.com

Great Britain
VARIOHM- EUROSENSORS Ltd.
www.variohm.com



ORBIT MERRET, spol. s r. o.
holds the following certificates:



ORBIT MERRET® represents in the Czech Republic and Slovakia the following companies:

