

# OMX 390T

## Digital DIN rail mounted signal conditioner

INPUT FOR STRAIN GAUGES

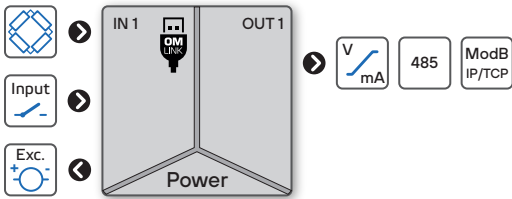

- Input 1...2/2...4/4...8/8...16 mV/V
- Analog output
- Up to 7 200 measurements/s
- Quick configuration by DIP switch
- PC configurable via USB port
- Galvanic isolation 2.5 kVAC
- Simple installation to DIN rail

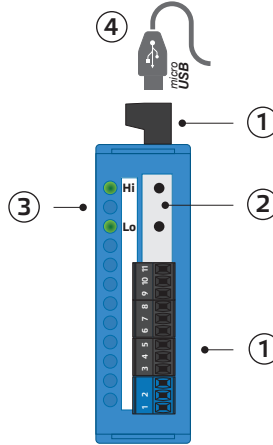

### LED Indication

Hi	Lo	Status
●		Device is running
✱		Device functionality is limited, powered via USB
✱		This device has a Delayed Start option
●		Error: device is out of order
●	○	Tare function is activated
●	●	Error: of input (> ±110% of range) or of sensor [ERR.1- 2]
●	●	Error: AO loop open [ERR.10]
●	●	Error: setting/ calibration [ERR.34-36]
✱	✱	Serious error (Safe mode) [ERR.50]
✱	✱	Button function is blocked
●	●	Simulation mode is activated

### Legend

- ① Connectors
- ② Control button
- ③ RGB Status LED
- ④ microUSB port for PC connection

<b>⚠ DANGER ⚠</b>	<b>⚠ WARNING ⚠</b>
<p><b>HAZARD OF ELECTRICAL SHOCK</b></p> <ul style="list-style-type: none"> <li>- Disconnect all power and other supply lines before servicing equipment</li> </ul> <p>Failure to follow this instruction may result in death or serious injury.</p>	<p><b>EQUIPMENT OPERATION HAZARD</b></p> <ul style="list-style-type: none"> <li>- Do not use this product in safety critical system</li> <li>- Do not disassemble, repair or modify this product</li> <li>- Do not operate beyond the recommended operating environment</li> </ul> <p>Failure to follow these instructions may result in death, serious injury, or equipment damage.</p>

Electrical equipment should be installed, operated, serviced, and maintained only by qualified personnel. No responsibility is assumed by ORBIT MERRET for any consequences arising out of the use of this device.

## 2 Connection

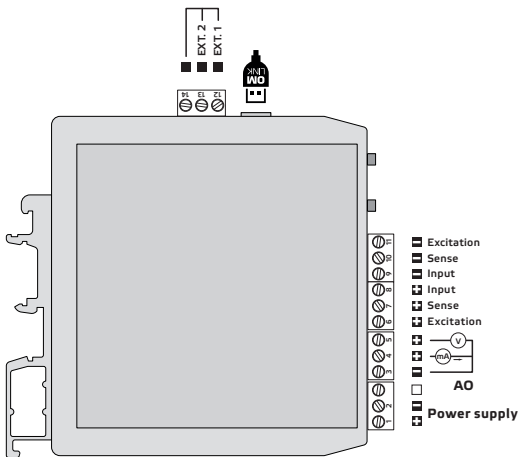

### Note

Contactors, high power electric motors, frequency drives and other power devices should not be in a close proximity of the meter. Input signal leads (measured value) should be separated from all power lines and power devices. Even though the device has been designed and tested according to standards for industrial environment, we strongly advise to adhere to the above presented rules.

	0,05...2,5mm <sup>2</sup> 30...12 AWG		8 0.32
	Ø 3,5 mm Ø 0.14 in		1,5 Nm 13.2 lb-in

## Input wiring diagram

Input - Strain gauges [4-wire]

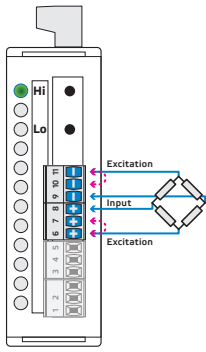

Input - Strain gauges [6-wire]

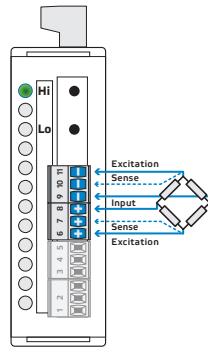

Input - External inputs

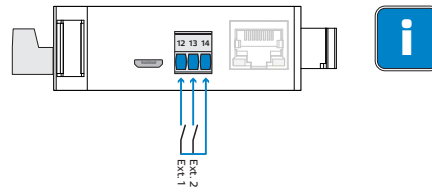

Control of external inputs is via contact (voltage-free)

## Output wiring diagram

Analog current output [mA]

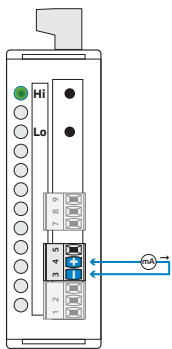

Analog Voltage Output [V]

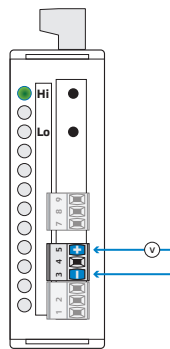

## Cumulative measurement

Example

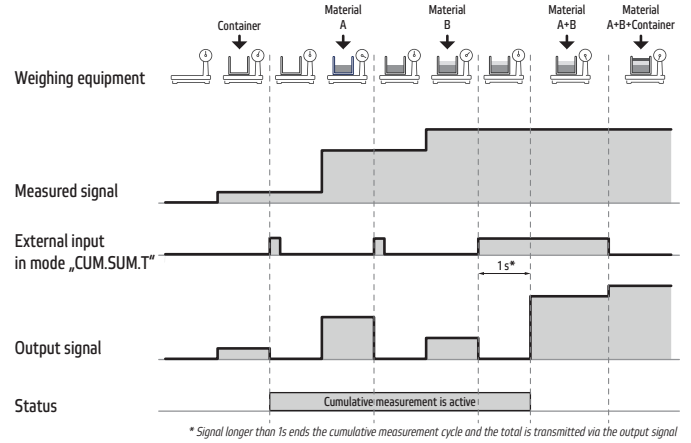

\* Signal longer than 1s ends the cumulative measurement cycle and the total is transmitted via the output signal

### Analog output

0...5/20 mA	3 - 4
4...20 mA	
0...2/5/10 V	3 - 5
±10 V	

## 3

## Device setting

### DIP switch

For a quick set up you can use the DIP switch. Changing a configuration only takes effect after power off/on.

1 2	Input
	Working Mode includ. Teach-IN, Tara (default)
●	1...2 mV/V
●	2...4 mV/V
●	4...8 mV/V
	range 8...16 mV/V is only selectable via the OM Link SW

3 4 5	Rate [measurements/s]
	50
●	300
●	400
●	400 - FFT
●	1200
●	2400
●	4800
●	7200 (default)

6 7 8	Output - range
	0...2 V
●	0...5 V
●	0...10 V
●	±10 V
●	0...5 mA
●	0...20 mA
●	4...20 mA (default)
●	20...4 mA



Minimum range of **Analog output** for U/I inputs signals is pre-set as unipolar, i.e. "0 V/mA" or "4 mA". If required, it is also possible to enter a negative value of the maximum in the minimum, i.e. zero will be in the middle of the selected range.

### Analog input range setting, TEACH-IN

1. Enter the teach-IN mode by a short press of the **Lo** button - LED **Hi** ✨ yellow and LED **Lo** ● turquoise
2. Put the connected sensor in the position that shall have minimum output **RNG.MIN** (for example 0.02 mV)
3. Set the minimum output value by a long press (>2 s) of the **Lo** button - LED **Hi** ✨ yellow, LED **Lo** ● purple
4. Put the connected sensor in the position that shall have maximum output **RNG.MAX**. (for example 20.01 mV)
5. Set the maximum output value by a long press (>2 s) of the **Lo** button - LED **Hi** ✨ yellow, LED **Lo** ● green
6. Leave teach-IN mode by a short press of the **Lo** button and return to the standard working mode - LED **Hi** ● green

The teached measuring range is non volatile and retained even after power off/on



Setting of **Analog input TEACH-IN** is active only when DIP switches No. 1-2 are in the "0" position, i.o. **Setting via OM Link**



In order to avoid possible unintended changes to settings by accidentally pressing the **Hi** and **Lo** buttons, these buttons can be **disabled** by connecting **terminals No. 12 and 14** of external inputs EXT.1 (wire jumper).

### Zero settings (Tare)

1. Enter the tare mode by a short press of the **Hi** button - LED **Hi** ✨ white and LED **Lo** ● turquoise
2. Put the connected sensor in the position where the tare function shall be executed
3. Set the tare by a long press (>2s) of the **Hi** button - LED **Hi** ✨ white, LED **Lo** ● green
4. Leave tare mode by a short press of the **Hi** button - LED **Hi** ● green, LED **Lo** ○ white

The tare is always reset automatically when the device is switched off.

### Offset settings, Teach-In

1. Enter the Teach-in for Offset mode by a long press of the **Hi** button - LED **Hi** ✨ white and LED **Lo** ✨ turquoise
2. Put the connected sensor in the position where the Offset function shall be executed
3. Set the Offset by a long press (>2s) of the **Hi** button - LED **Hi** ✨ white, LED **Lo** ● green
4. Leave Offset mode by a short press of the **Hi** button - LED **Hi** ● green, LED **Lo** ○ white



A short press at any time during the calibration will end the calibration without saving. After one minute of inactivity, the calibration is terminated without saving and both LEDs return to the basic state.

## Inputs

Reset of Tare	CLEAR	>	<input type="button" value="CL.TAR."/>	Tare resetting
Sampling rate	READ. S.	>	<input type="button" value="50"/> <input type="button" value="100"/> <input type="button" value="400"/> <input type="button" value="1200"/> <input type="button" value="2400"/> <input type="button" value="4800"/> <input type="button" value="7200"/>	Measuring rate selection
Measuring range	M.RANGE	>	<input type="button" value="2 mV/V"/> <input type="button" value="4 mV/V"/> <input type="button" value="8 mV/V"/> <input type="button" value="16 mV/V"/>	Measuring range selection
Offset, Teach-in	T-IN.OF.	>	<input type="button" value="YES"/>	Offset setting (shift "0") in learning mode
Offset	OFFSET	>	<input type="text" value="0...9999"/>	Setting the offset value ("0")
Setting of converted value	RNG.MIN.	>	<input type="text" value="-99999...0...999999"/>	For the minimum of the selected input range
	RNG.MAX.	>	<input type="text" value="-99999...20...999999"/>	For the maximum of the selected input range*
Input setting Expert	TEACH-IN	>	<input type="button" value="T-IN.LO"/> <input type="button" value="T-IN.HI"/>	Setting the input range in the Teach-in mode
	MANUAL	>	<input type="button" value="MAN.LO"/> <input type="button" value="MAN.HI"/>	Setting the input range in the Manual mode
Digital filters	F.MODE	>	<input type="button" value="OFF"/> <input type="button" value="AVERAG."/> <input type="button" value="FL.AVG."/> <input type="button" value="EXPON."/> <input type="button" value="ROUND."/>	Filters for math. adjust. of the input signal
Filter constant	F.CONST.	>	<input type="text" value="0...9999"/>	Setting the constant for the filter
Measuring mode	MODE	>	<input type="button" value="STAND."/> <input type="button" value="WEIGHT."/>	Selection of measuring mode (standard/weighting)
Zero tracking	TRACK.0	>	<input type="button" value="NO"/> <input type="button" value="YES"/>	Selection of zero tracking
Automatic Tare	A.TARE	>	<input type="button" value="NO"/> <input type="button" value="YES"/>	Selection of automatic tare
Scale division	SC. DIV.	>	<input type="button" value="0.001"/> <input type="button" value="0.002"/> <input type="button" value="0.005"/> <input type="button" value="0.01"/> <input type="button" value="0.02"/> <input type="button" value="0.05"/> <input type="button" value="0.1"/> <input type="button" value="0.2"/> <input type="button" value="0.5"/> <input type="button" value="1"/> <input type="button" value="2"/> <input type="button" value="5"/> <input type="button" value="10"/> <input type="button" value="20"/> <input type="button" value="50"/> <input type="button" value="100"/>	Selection of scale division
External input	EXT.IN.1	>	<input type="button" value="OFF"/> <input type="button" value="TARE"/> <input type="button" value="CL.TAR."/> <input type="button" value="TAR.-CL."/> <input type="button" value="CUM.SUM."/> <input type="button" value="T-IN.OF."/> <input type="button" value="HOLD"/> <input type="button" value="SAMPLE"/> <input type="button" value="HLD.MIN"/> <input type="button" value="HLD.MAX"/> <input type="button" value="HLD.M-M"/> <input type="button" value="HLD.PRM."/> <input type="button" value="KEY.LCK."/>	Fce selection EXT. 1
	EXT.IN.2	>	<input type="button" value="OFF"/> <input type="button" value="TARE"/> <input type="button" value="CL.TAR."/> <input type="button" value="TAR.-CL."/> <input type="button" value="CUM.SUM."/> <input type="button" value="T-IN.OF."/> <input type="button" value="HOLD"/> <input type="button" value="SAMPLE"/> <input type="button" value="HLD.MIN"/> <input type="button" value="HLD.MAX"/> <input type="button" value="HLD.M-M"/> <input type="button" value="HLD.PRM."/> <input type="button" value="KEY.LCK."/>	Fce selection EXT. 2

\*In case you know the exact sensitivity of the load cell, input it into this menu item (RNG.MAX)

## Function

Mathematical function	INP. M.F.	>	<input type="button" value="OFF"/> <input type="button" value="INPUT"/> <input type="button" value="INP.FIL."/> <input type="button" value="INP.ABS."/>	Input selection for the math function
	TYPE.M.F.	>	<input type="button" value="POLYN."/> <input type="button" value="IN.POL."/> <input type="button" value="LOGAR."/> <input type="button" value="EXPON."/> <input type="button" value="POWER"/> <input type="button" value="SQ.ROOT"/>	
	CONST. A ... F	>	<input type="text" value="0...99"/>	Setting constants for mathematical functions
Linearization table	INP. L.T.	>	<input type="button" value="OFF"/> <input type="button" value="INPUT"/> <input type="button" value="FILTER."/>	Input selection for the linearization table
	N.OF.PTS.	>	<input type="text" value="5...100"/>	Number of points in the table
	VALUES	>	<input type="text" value="-9999...99999"/>	Values of X/Y

## Output

Analog output	INP. A.O.	>	<input type="button" value="INPUT"/> <input type="button" value="INP.FIL."/> <input type="button" value="INP.ABS."/> <input type="button" value="MAT.FNC."/> <input type="button" value="LIN.TAB."/>	Selection of input for analogue output
	A.O.TYPE	>	<input type="button" value="0-2 V"/> <input type="button" value="0-5 V"/> <input type="button" value="0-10 V"/> <input type="button" value="±10 V"/> <input type="button" value="0-5 mA"/> <input type="button" value="0-20 mA"/> <input type="button" value="4-20 mA"/>	Selection of range for analogue output
	A.O. MIN.	>	<input type="text" value="-99999...0...99999"/>	Assigning the value of the input to the lower end of the range of AO
	A.O. MAX.	>	<input type="text" value="-99999...100...99999"/>	Assigning the value of the input to the upper end of the range of AO

## Service

Setting of password	PASSW.	>	<input type="text" value="0...9999"/>	Password to connect the device to PC. If it is set to "0", access is not blocked
Delayed Start	DLY.STR.	>	<input type="text" value="0...99"/>	Setting the time [sec.] - when the measurement is not performed after powering the device on
Save user settings	SAV.SET.	>	<input type="button" value="YES"/>	Saves the current device settings
Load user settings	LOA.SET.	>	<input type="button" value="YES"/>	Loads the user settings into the device
Factory reset	FACT.ST.	>	<input type="button" value="YES"/>	Loads the original factory settings, restores the initial settings (BLUE TEXTS)
Erase user calibration	CLR.CAL.	>	<input type="button" value="YES"/>	Clears user calibration, restores factory calibrations (after user calibration by script via OM Link SW had been performed)
Key lock	KEY.LCK.	>	<input type="button" value="ON"/> <input type="button" value="OFF"/>	Disables the push button(s) on the front panel of the device
Error selection for signalling	SIG.ERR.	>	<input type="button" value="ERR 1"/> <input type="button" value="ERR 2"/> <input type="button" value="ERR 10"/> <input type="button" value="ERR 20"/> <input type="text" value="..."/>	Errors that will be signalled on the selected output
Simulation of input signal	SIM.MIN.	>	<input type="button" value="MIN"/> <input type="text" value="-99999...0...99999"/>	Setting of the start of the range for simulation
	SIM.MAX.	>	<input type="button" value="MAX"/> <input type="text" value="-99999...100...99999"/>	Setting of the end of the range for simulation
	STEP	>	<input type="text" value="-99999...1...999999"/>	Setting of increment/step value
	TIME	>	<input type="text" value="0...100...999.9"/>	Setting the increment/step duration time [sec.]
	START	>	<input type="button" value="STOP"/> <input type="button" value="YES"/>	Start of simulation
	STOP	>	<input type="button" value="START"/> <input type="button" value="YES"/>	Stop of simulation

## Error messages

Error	Error description	Solution
ERR 1	Input range exceeded by ±10% or more.	Change input signal value or input setting (range).
ERR 2	AD converter overflow / underflow.	Change input signal value or input setting (range).
ERR 10	Output current loop broken.	Check cable and current loop connection.
ERR 20	Math function error.	Change math function settings.
ERR 21	Linearization table error.	Change/complete the settings of the linearization table.
ERR 30	Powered only by USB, analog circuits inactive.	Connect power supply to the device (clamp 1,2).
ERR 34	User configuration could not be loaded from EEPROM. Default configuration automatically applied.	Repeat device configuration. If message is shown repeatedly, send the device for repair.
ERR 35	Factory calibration has been lost. Converter's accuracy is compromised up to ±5%	When this error occurs, send the device for re-calibration or upload factory calibration data.
ERR 36	User calibration could not be loaded from EEPROM. Factory calibration automatically applied.	Repeat the user calibration. If message is shown repeatedly, send the device for repair.
ERR 50	Serious device error - damaged EEPROM. The device operates in an emergency mode, i.e. settings cannot be changed. Measurement error can be up to 5%	Send the device for repair.

Errors ERR 34-50 are displayed permanently, until they are corrected.



The USB connector is galvanically connected to the input! USB-to-USB Isolator must be used when input signal is connected to the device.  
**DANGER OF COMPUTER DAMAGE**

# 5 Instrument dimensions and installation

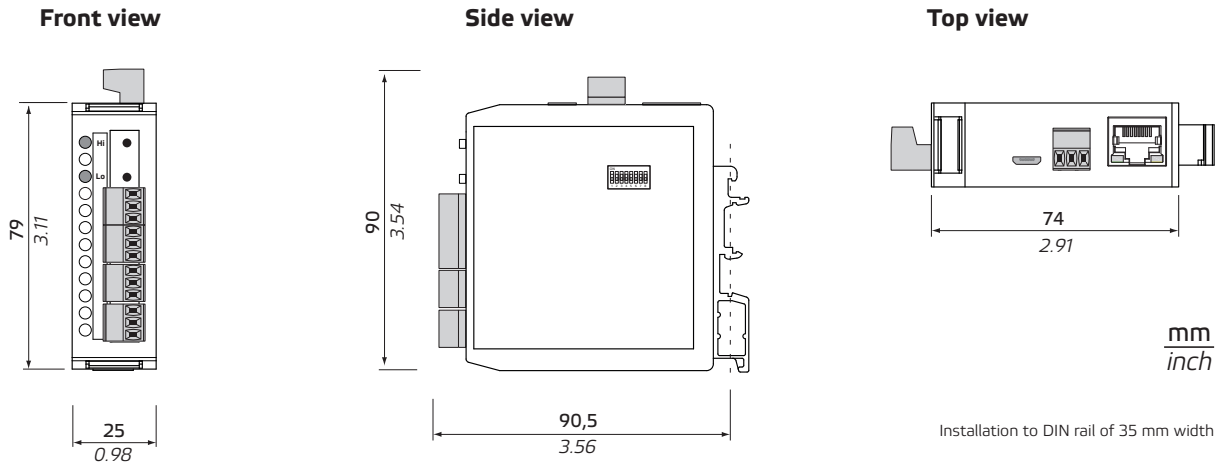

# 6 Technical data

## INPUT

No. of inputs	1
Setting	24-bit $\Delta\Sigma$ ADC with PGA The range is selectable either by DIP switch or by OM Link free SW from PC
Range	1..2 mV/V 2..4 mV/V 4..8 mV/V 8..16 mV/V
Sensor power supply	10 VDC, load $\geq$ 80 $\Omega$ on request 5 V
Connection	6-wire

## EXTERNAL INPUT

No. of inputs	2, on contact
Function	OFF No function assigned TARE Activation of Tare CL.TAR. Clear Taree TAR.-CL. Activat. of Tare (<1 s) + clear Tare (>1 s) T-IN.OF. Activation of Tech-In for Offset CUM.SUM. Control of Cumulative measurement HOLD Measurement paused SAMPLE Initiates a one-off measurement HLD.MIN Hold - Value of Minimum* HLD.MAX Hold - Value of Maximum* HLD.M-M Hold - Value of MAX-MIN* HLD.AVG Hold - Average value* KEY.LCK. Device buttons blocked

\*The value is calculated from the period starting with the previous external input activation.

## INSTRUMENT SPECIFICATION

TC	15 ppm/ $^{\circ}$ C
Accuracy	$\pm$ 0.02% of FS
Rate	100...7 200 measurements/s speed of 400 meas./s is with FFT signal filtering
Latency	< 580 $\mu$ s
Overload	10x (t < 30 ms), 2x
Functions	Teach-in, tare, offset, min/max value, math. functions, delayed start, simulation
Weighing functions	automatic zero tracking, automatic tare, setting of scale division (0.001...100)
Digital filters	exponential / floating / arithmetic average, ouding
Math functions	polynomial / inverse polynomial / logarithm / exponential / power / root
Linearization	linear interpolation in 100 points only via OM Link
OM Link	company communication interface for operation, setting and update of instruments. (microUSB)
Watch-dog	reset after 500 ms
Calibration	at 25 $^{\circ}$ C and 40% r.h.

## ANALOG OUTPUT

No. of outputs	1																								
Type	isolated, adjustable with 16-bit DAC, output type and range is selectable																								
TC	15 ppm/ $^{\circ}$ C																								
Accuracy	$\pm$ 0.02% of FS $\pm$ 0.03% of FS $\pm$ 0.05% of FS																								
Rate	response to change of value < 160 $\mu$ s																								
Output signals	<table border="0"> <tr> <td>Range</td> <td>Error indication</td> <td></td> </tr> <tr> <td>0..2 V</td> <td>-2.2 V</td> <td>resistive load <math>\geq</math> 1 k<math>\Omega</math></td> </tr> <tr> <td>0..5 V</td> <td>-5.5 V</td> <td>resistive load <math>\geq</math> 1 k<math>\Omega</math></td> </tr> <tr> <td>0..10 V</td> <td>-11.0 V</td> <td>resistive load <math>\geq</math> 1 k<math>\Omega</math></td> </tr> <tr> <td><math>\pm</math>10 V</td> <td>-11.0 V</td> <td>resistive load <math>\geq</math> 1 k<math>\Omega</math></td> </tr> <tr> <td>0..5 mA</td> <td>-5.5 mA</td> <td>compensation &lt; 600 <math>\Omega</math>/12 V</td> </tr> <tr> <td>0..20 mA</td> <td>-22.0 mA</td> <td>compensation &lt; 600 <math>\Omega</math>/12 V</td> </tr> <tr> <td>4..20 mA</td> <td>-3.2 mA</td> <td>compensation &lt; 600 <math>\Omega</math>/12 V</td> </tr> </table> Indication of broken current loop	Range	Error indication		0..2 V	-2.2 V	resistive load $\geq$ 1 k $\Omega$	0..5 V	-5.5 V	resistive load $\geq$ 1 k $\Omega$	0..10 V	-11.0 V	resistive load $\geq$ 1 k $\Omega$	$\pm$ 10 V	-11.0 V	resistive load $\geq$ 1 k $\Omega$	0..5 mA	-5.5 mA	compensation < 600 $\Omega$ /12 V	0..20 mA	-22.0 mA	compensation < 600 $\Omega$ /12 V	4..20 mA	-3.2 mA	compensation < 600 $\Omega$ /12 V
Range	Error indication																								
0..2 V	-2.2 V	resistive load $\geq$ 1 k $\Omega$																							
0..5 V	-5.5 V	resistive load $\geq$ 1 k $\Omega$																							
0..10 V	-11.0 V	resistive load $\geq$ 1 k $\Omega$																							
$\pm$ 10 V	-11.0 V	resistive load $\geq$ 1 k $\Omega$																							
0..5 mA	-5.5 mA	compensation < 600 $\Omega$ /12 V																							
0..20 mA	-22.0 mA	compensation < 600 $\Omega$ /12 V																							
4..20 mA	-3.2 mA	compensation < 600 $\Omega$ /12 V																							

## POWER SUPPLY

Power	10...30 VDC/24 VAC, $\pm$ 10%, PF $\geq$ 0.4, $I_{typ}$ < 40 A/1 ms, isolated Fuse inside (1500mA)
Consumption	< 3.4 W / 3.3 VA < 5.0 W / 4.9 VA (at 80 $\Omega$ load)

## MECHANIC PROPERTIES

Material	PA66, incombustible UL 94 V-0, green
Dimensions	25 x 79 x 90.5 mm (w x h x d)
Installation	to DIN rail 35 mm wide

## OPERATING CONDITIONS

Connection	connector terminal blocks, section < 1.5 mm <sup>2</sup>
Stabilization period	within 5 minutes after switch-on
Working temp.	-20...60 $^{\circ}$ C
Storage temp.	-20...85 $^{\circ}$ C
Working humidity	< 95% r.h., non condensing
Protection	IP20
Construction	safety class I
EL safety	EN 61010-1, A2
Dielectric strength	2.5 kVAC for 1 min. between power supply and signal input 2.5 kVAC for 1 min. between signal input and outputs
Insulation resistance*	for pollution degree II, measurement cat. III power supply > 300 V (PI), 255 V (DI) Input/outputs > 300 V (PI)
EMC	EN 61326-1 (Industrial area)
RoHS	EN IEC 63000:2018
Seismic qualification	IEC/IEEE 60980-344 ed. 1.0:2020, par. 6, 9
Mechanical resistance	EN 60068-2-6 ed. 2:2008

\* PI - Primary insulation, DI - Double insulation



On our website [www.orbitmerret.eu](http://www.orbitmerret.eu) there are Application sheets available for the products under the "Download Support" tab, which provide a detailed description of the properties, functions and use of the device.



ORBIT MERRET, spol. s r.o.

Vodňanská 675/30  
198 00 Praha 9  
Czech Republic

+420 - 281 040 200 info@orbitmerret.eu

Measuring instruments of the OMX 390T series conform to the European regulation 2014/30/EU, 2014/35/EU and 2011/65/EU, 2015/863/EU.

This product must be installed, connected and used in compliance with prevailing standards and/or installation regulations. As standards, specifications and designs develop from time to time, always ask for confirmation of the information given in this publication.