

- Input for potentiometers
- Data output Modbus TCP/IP
- Up to 7 200 measurements/s
- Quick configuration by DIP switch
- PC configurable via USB port
- Galvanic isolation 2.5 kVAC
- Simple Installation to DIN rail

OMX 390DU

Digital DIN rail mounted signal conditioner

INPUT FOR POTENTIOMETERS

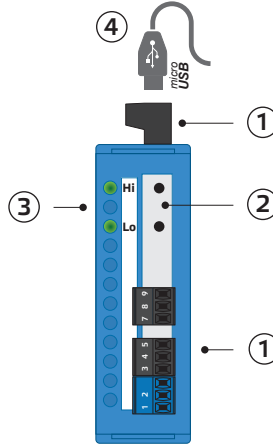
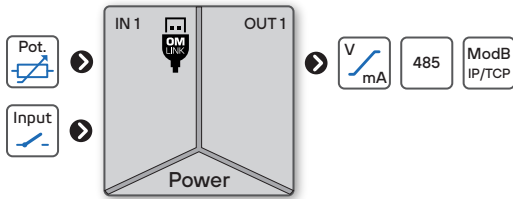

LED Indication

Hi	Lo	Status
●		Device is running
✱		Device functionality is limited, powered via USB
✱		This device has a Delayed Start option
●		Error: device is out of order
●	○	Tare function is activated
●	●	Error: of input (> ±110% of range) or of sensor [ERR.1, 3]
●	●	Error: AO loop open [ERR.10]
✱	✱	Error: setting/ calibration [ERR.34-36]
✱	✱	Serious error (Safe mode) [ERR.50]
✱	✱	Button function is blocked (LED flashes 2x)
●	●	Simulation mode is activated

Legend

- ① Connectors
- ② Control button
- ③ RGB Status LED
- ④ microUSB port for PC connection

⚠ DANGER ⚠	⚠ WARNING ⚠
<p>HAZARD OF ELECTRICAL SHOCK</p> <ul style="list-style-type: none"> - Disconnect all power and other supply lines before servicing equipment <p>Failure to follow this instruction may result in death or serious injury.</p>	<p>EQUIPMENT OPERATION HAZARD</p> <ul style="list-style-type: none"> - Do not use this product in safety critical system - Do not disassemble, repair or modify this product - Do not operate beyond the recommended operating environment <p>Failure to follow these instructions may result in death, serious injury, or equipment damage.</p>

Electrical equipment should be installed, operated, serviced, and maintained only by qualified personnel. No responsibility is assumed by ORBIT MERRET for any consequences arising out of the use of this device.

2 Connection

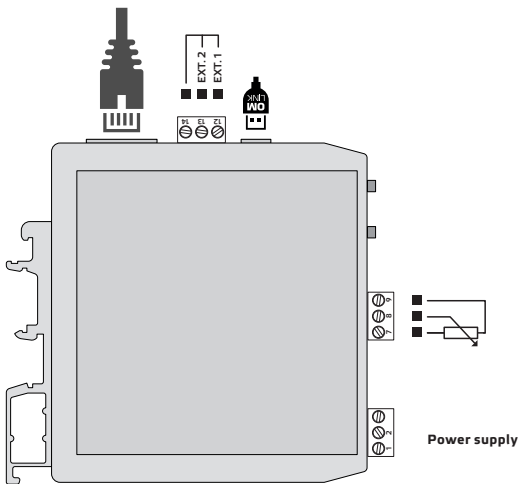

Note

Contactors, high power electric motors, frequency drives and other power devices should not be in a close proximity of the meter. Input signal leads (measured value) should be separated from all power lines and power devices. Even though the device has been designed and tested according to standards for industrial environment, we strongly advise to adhere to the above presented rules.

	0,05...1,5 mm ² 30...16 AWG	
	Ø 3,5 mm Ø 0.14 in	

Wiring diagram

Input - Potentiometers

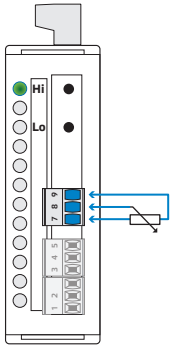

Input - External inputs

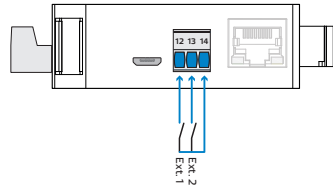

Data output RS485

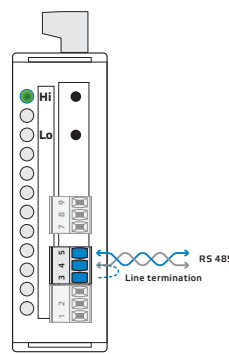

Control of external inputs is via contact (voltage-free)



The RS 485 line needs to have a proper linear structure - wires (ideally shielded and twisted) should lead from one node to another.

Terminate the RS 485 data line (on the last device) with a jumper between connectors No. 3 and 4. The internal terminating resistor has the value of 120 Ω.

3 Device setting

DIP switch

For a quick set up you can use the DIP switch. Changing a configuration only takes effect after power off/on.

1	2	Input
		Working Mode includ. Teach-IN, Tara (default)
●		Potentiometer (default)

3	4	5	Rate [measurements/s]
			50
●			300
●		●	400
●	●		400 - FFT
●		●	1200
●	●	●	2400
●	●	●	4800
●	●	●	7200 (default)

6	7	8	Data output
			Modbus TCP/IP (default)

Analog input range setting, TEACH-IN

1. Enter the teach-IN mode by a short press of the **Lo** button - LED **Hi** ✨ yellow and LED **Lo** ● turquoise
 2. Put the connected sensor in the position that shall have minimum output **RNG.MIN** (for example 4.02 Ω)
 3. Set the minimum output value by a long press (>2 s) of the **Lo** button - LED **Hi** ✨ yellow, LED **Lo** ● purple
 4. Put the connected sensor in the position that shall have maximum output **RNG.MAX**. (for example 997.2 Ω)
 5. Set the maximum output value by a long press (>2 s) of the **Lo** button - LED **Hi** ✨ yellow, LED **Lo** ● green
 6. Leave teach-IN mode by a short press of the **Lo** button and return to the standard working mode - LED **Hi** ● green
- The teached measuring range is non volatile and retained even after power off/on



Setting of **Analog input TEACH-IN** is active only when DIP switches No. 1-2 are in the "0" position, i.o. **Setting via OM Link**



In order to avoid possible unintended changes to settings by accidentally pressing the **Hi** and **Lo** buttons, these buttons can be **disabled** by connecting **terminals No. 12 and 14** of external inputs EXT.1 (wire jumper).

Zero settings (Tare)

1. Enter the tare mode by a short press of the **Hi** button - LED **Hi** ✨ white and LED **Lo** ● turquoise
 2. Put the connected sensor in the position where the tare function shall be executed
 3. Set the tare by a long press (>2s) of the **Hi** button - LED **Hi** ✨ white, LED **Lo** ● green
 4. Leave tare mode by a short press of the **Hi** button - LED **Hi** ● green, LED **Lo** ○ white
- The tare is always reset automatically when the device is switched off.

Offset settings, Teach-In

1. Enter the Teach-in for Offset mode by a long press of the **Hi** button - LED **Hi** ✨ white and LED **Lo** ✨ turquoise
2. Put the connected sensor in the position where the Offset function shall be executed
3. Set the Offset by a long press (>2s) of the **Hi** button - LED **Hi** ✨ white, LED **Lo** ● green
4. Leave Offset mode by a short press of the **Hi** button - LED **Hi** ● green



A short press at any time during the calibration will end the calibration without saving. After one minute of inactivity, the calibration is terminated without saving and both LEDs return to the basic state.

Description of Modbus registers

The new device protocol supports reading and writing multiple registers at the same time. Each register is 2 bytes in size. Values of type float32 are stored in two registers (4 bytes).

You can find a detailed description of the protocol on our website

Modbus Protocol Registry Application Sheet
https://www.orbitmerret.eu/cs/document-download?document_id=13642

4 Configuration from PC using OM Link SW

Inputs

Reset of Tare	CLEAR	>	<input type="button" value="CL.TAR."/>	Tare resetting	
Sampling rate	READ. S.	>	<input type="button" value="50"/> <input type="button" value="100"/> <input type="button" value="400"/> <input type="button" value="1200"/> <input type="button" value="2400"/> <input type="button" value="4800"/> <input type="button" value="7200"/>	Measuring rate selection	
Measuring range	M.RANGE	>	<input type="button" value="0-100%"/>	Measuring range selection	
Offset, Teach-in	T-IN.OF	>	<input type="button" value="YES"/>	Offset setting (shift "0") in learning mode	
Offset	OFFSET	>	<input type="text" value="0...9999"/>	Setting the offset value ("0")	
Setting of converted value	RNG.MIN.	>	<input type="text" value="-99999...0...999999"/>	For the minimum of the selected input range	
	RNG.MAX.	>	<input type="text" value="-99999...100...999999"/>	For the maximum of the selected input range	
Input setting Expert	TEACH-IN	>	<input type="button" value="T-IN.LO"/> <input type="button" value="T-IN.HI"/>	Setting the input range in the Teach-in mode	
	MANUAL	>	<input type="button" value="MAN.LO"/> <input type="button" value="MAN.HI"/>	Setting the input range in the Manual mode	
Digital filters	F.MODE	>	<input type="button" value="OFF"/> <input type="button" value="AVERAG."/> <input type="button" value="FL.AVG."/> <input type="button" value="EXPON."/> <input type="button" value="ROUND."/>	Filters for math adjust of the input signal	
Filter constant	F.CONST.	>	<input type="text" value="0...9999"/>	Setting the constant for the filter	
External input	EXT.IN.1	>	<input type="button" value="OFF"/> <input type="button" value="TARE"/> <input type="button" value="CL.TAR."/> <input type="button" value="TAR.-CL."/> <input type="button" value="CUM.SUM."/> <input type="button" value="T-IN.OF"/> <input type="button" value="HOLD"/> <input type="button" value="SAMPLE"/> <input type="button" value="HLD.MIN"/> <input type="button" value="HLD.MAX"/> <input type="button" value="HLD.M-M"/> <input type="button" value="HLD.PRM."/> <input type="button" value="KEY.LCK"/>	Fce selection EXT. 1	
	EXT.IN.2	>	<input type="button" value="OFF"/> <input type="button" value="TARE"/> <input type="button" value="CL.TAR."/> <input type="button" value="TAR.-CL."/> <input type="button" value="CUM.SUM."/> <input type="button" value="T-IN.OF"/> <input type="button" value="HOLD"/> <input type="button" value="SAMPLE"/> <input type="button" value="HLD.MIN"/> <input type="button" value="HLD.MAX"/> <input type="button" value="HLD.M-M"/> <input type="button" value="HLD.PRM."/> <input type="button" value="KEY.LCK"/>	Fce selection EXT. 2	

<input type="button" value="T-IN.LO"/>	Device measures the value of the Lo signal
<input type="button" value="YES"/>	Lo signal connection confirmed
<input type="button" value="T-IN.HI"/>	Device measures the value of the Hi signal
<input type="button" value="YES"/>	Hi signal connection confirmed
<input type="button" value="MAN.LO"/>	Manual entry of Lo input signal for MIN
<input type="text" value="4.02"/>	Entry of signal value (example: 4.02 Ω)
<input type="button" value="MAN.HI"/>	Manual entry of Hi input signal for MAX
<input type="text" value="997.2"/>	Entry of signal value (example: 997.2 Ω)

Function

Mathematical function	INP. M.F.	>	<input type="button" value="OFF"/> <input type="button" value="INPUT"/> <input type="button" value="INP.FIL."/> <input type="button" value="INP.ABS."/>	Input selection for the math function	
	TYPE.M.F.	>	<input type="button" value="POLYN."/> <input type="button" value="IN.POL."/> <input type="button" value="LOGAR."/> <input type="button" value="EXPON."/> <input type="button" value="POWER"/> <input type="button" value="SQ.ROOT"/>		
	CONST. A ... F	>	<input type="text" value="0...99"/>	Setting constants for mathematical functions	
Linearization table	INP. L.T.	>	<input type="button" value="OFF"/> <input type="button" value="INPUT"/> <input type="button" value="INP.FIL."/> <input type="button" value="INP.ABS."/>	Input selection for the linearization table	
	N.OF.PTS.	>	<input type="text" value="5...100"/>	Number of points in the table	
	VALUES	>	<input type="text" value="-9999...99999"/>	Values of X/Y	

<input type="button" value="POLYN."/>	Polynomial	$Ax^2 + Bx^3 + Cx^3 + Dx^2 + Ex + F$
<input type="button" value="IN.POL."/>	Inv. polynomial	$\frac{A}{x^2} + \frac{B}{x^3} + \frac{C}{x^2} + \frac{D}{x^2} + \frac{E}{x} + F$
<input type="button" value="LOGAR."/>	Logarithmic	$A \times \ln\left(\frac{Bx+C}{Dx+E}\right) + F$
<input type="button" value="EXPON."/>	Exponential	$A \times e^{\left(\frac{Bx+C}{Dx+E}\right)} + F$
<input type="button" value="POWER."/>	Power	$A \times (Bx+C)^{(Dx+E)} + F$
<input type="button" value="SQ.ROOT."/>	Square root	$A \times \sqrt{\frac{Bx+C}{Dx+E}}$

Output

Modbus TCP/IP	DHCP	>	<input type="button" value="YES"/> <input type="button" value="NO"/>	Selection of assigning IP addresses
	IPADR.	>	<input type="text" value="192.168.88.40"/>	IP Address setting (IPv4)
	MASK	>	<input type="text" value="255.255.255.0"/>	Subnet Mask setting
	GATE	>	<input type="text" value="192.168.88.1"/>	Default Gateway setting
	PORT	>	<input type="text" value="1...502...65535"/>	Port setting

Service

Setting of password	PASSW.	>	<input type="text" value="0...9999"/>	Password to connect the device to PC. If it is set to "0", access is not blocked
Delayed Start	DLY.STR.	>	<input type="text" value="0...99"/>	Setting the time [sec.] - when the measurement is not performed after powering the device on
Save user settings	SAV.SET.	>	<input type="button" value="YES"/>	Saves the current device settings
Load user settings	LOA.SET.	>	<input type="button" value="YES"/>	Loads the user settings into the device
Factory reset	FACT.ST.	>	<input type="button" value="YES"/>	Loads the original factory settings, restores the initial settings (BLUE TEXTS)
Erase user calibration	CLR.CAL.	>	<input type="button" value="YES"/>	Clears user calibration, restores factory calibrations (after user calibration by script via OM Link SW had been performed)
Key lock	KEY.LCK.	>	<input type="button" value="ON"/> <input type="button" value="OFF"/>	Disables the push button(s) on the front panel of the device
Error selection for signalling	SIG.ERR.	>	<input type="button" value="ERR 1"/> <input type="button" value="ERR 3"/> <input type="button" value="ERR 20"/> <input type="button" value="ERR 21"/> ...	Errors that will be signalled on the selected output
Simulation of input signal	SIM.MIN.	>	<input type="text" value="MIN"/> <input type="text" value="-99999...0...99999"/>	Setting of the start of the range for simulation
	SIM.MAX.	>	<input type="text" value="MAX"/> <input type="text" value="-99999...100...99999"/>	Setting of the end of the range for simulation
	STEP	>	<input type="text" value="-99999...1...999999"/>	Setting of increment/step value
	TIME	>	<input type="text" value="0...100...999.9"/>	Setting the increment/step duration time [sec]
	START	>	<input type="button" value="STOP"/> <input type="button" value="YES"/>	Start of simulation
	STOP	>	<input type="button" value="START"/> <input type="button" value="YES"/>	Stop of simulation

Error messages

Error	Error description	Solution
ERR 1	Input range exceeded by +10% or more.	Change input signal value or input setting (range).
ERR 3	Potentiometer wire broken.	Check sensor cable and connection.
ERR 20	Math function error.	Change math function settings.
ERR 21	Linearization table error.	Change/complete the settings of the linearization table.
ERR 30	Powered only by USB, analog circuits inactive.	Connect power supply to the device (clamp 1,2).
ERR 34	User configuration could not be loaded from EEPROM. Default configuration automatically applied.	Repeat device configuration. If message is shown repeatedly, send the device for repair.
ERR 35	Factory calibration has been lost. Converter's accuracy is compromised up to ±5%	When this error occurs, send the device for re-calibration or upload factory calibration data.
ERR 36	User calibration could not be loaded from EEPROM. Factory calibration automatically applied.	Repeat the user calibration. If message is shown repeatedly, send the device for repair.
ERR 50	Serious device error - damaged EEPROM. The device operates in an emergency mode, i.e. settings cannot be changed. Measurement error can be up to 5%	Send the device for repair.

Errors ERR 34-50 are displayed permanently, until they are corrected.



The USB connector is galvanically connected to the input! USB-to-USB Isolator must be used when input signal is connected to the device.
DANGER OF COMPUTER DAMAGE

5 Instrument dimensions and installation

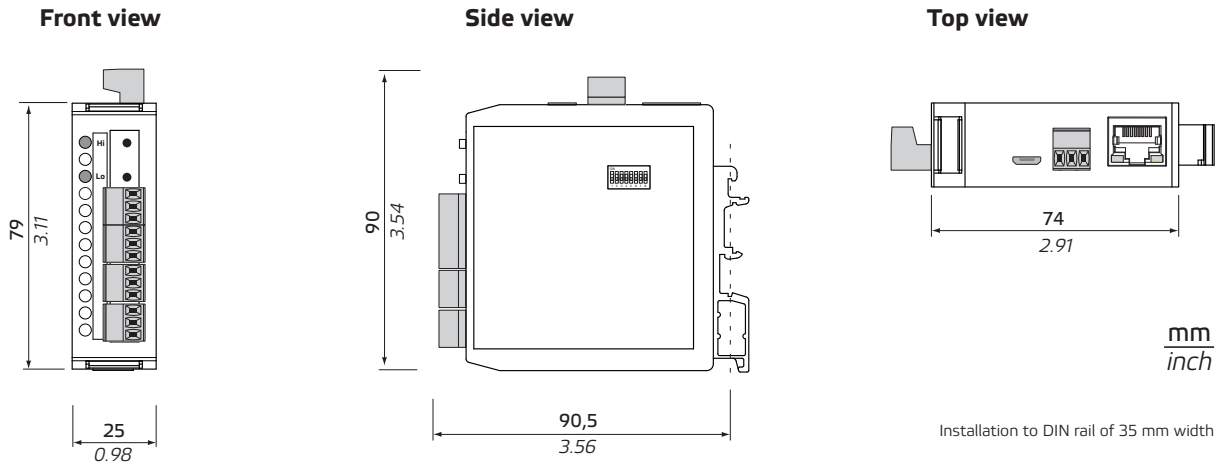

6 Technical data

INPUT

No. of inputs	1
Setting	24-bit $\Delta\Sigma$ ADC with PGA The range is selectable either by DIP switch or by OM Link free SW from PC
DU Power	2.5 VDC/5 mA, potentiometer resistance > 500 Ω

EXTERNAL INPUT

No. of inputs	2, on contact																										
Function	<table border="0"> <tr> <td>OFF</td> <td>No function assigned</td> </tr> <tr> <td>TARE</td> <td>Activation of Tare</td> </tr> <tr> <td>CL.TAR.</td> <td>Clear Tare</td> </tr> <tr> <td>TAR.-CL.</td> <td>Activat. of Tare (<1 s) + clear Tare (>1 s)</td> </tr> <tr> <td>T-IN.OF.</td> <td>Activation of Tech-In for Offset</td> </tr> <tr> <td>CUM.SUM.</td> <td>Control of Cumulative measurement</td> </tr> <tr> <td>HOLD</td> <td>Measurement paused</td> </tr> <tr> <td>SAMPLE</td> <td>Initiates a one-off measurement</td> </tr> <tr> <td>HLD.MIN</td> <td>Hold - Value of Minimum*</td> </tr> <tr> <td>HLD.MAX</td> <td>Hold - Value of Maximum*</td> </tr> <tr> <td>HLD.M-M</td> <td>Hold - Value of MAX-MIN*</td> </tr> <tr> <td>HLD.AVG</td> <td>Hold - Average value*</td> </tr> <tr> <td>KEY.LCK.</td> <td>Device buttons blocked</td> </tr> </table>	OFF	No function assigned	TARE	Activation of Tare	CL.TAR.	Clear Tare	TAR.-CL.	Activat. of Tare (<1 s) + clear Tare (>1 s)	T-IN.OF.	Activation of Tech-In for Offset	CUM.SUM.	Control of Cumulative measurement	HOLD	Measurement paused	SAMPLE	Initiates a one-off measurement	HLD.MIN	Hold - Value of Minimum*	HLD.MAX	Hold - Value of Maximum*	HLD.M-M	Hold - Value of MAX-MIN*	HLD.AVG	Hold - Average value*	KEY.LCK.	Device buttons blocked
OFF	No function assigned																										
TARE	Activation of Tare																										
CL.TAR.	Clear Tare																										
TAR.-CL.	Activat. of Tare (<1 s) + clear Tare (>1 s)																										
T-IN.OF.	Activation of Tech-In for Offset																										
CUM.SUM.	Control of Cumulative measurement																										
HOLD	Measurement paused																										
SAMPLE	Initiates a one-off measurement																										
HLD.MIN	Hold - Value of Minimum*																										
HLD.MAX	Hold - Value of Maximum*																										
HLD.M-M	Hold - Value of MAX-MIN*																										
HLD.AVG	Hold - Average value*																										
KEY.LCK.	Device buttons blocked																										

*The value is calculated from the period starting with the previous external input activation.

INSTRUMENT SPECIFICATION

TC	15 ppm/ $^{\circ}$ C
Accuracy	$\pm 0.01\%$ of FS
Rate	100...7 200 measurements/s speed of 400 meas./s is with FFT signal filtering
Latency	< 580 μ s
Overload	10x (t < 30 ms), 2x
Functions	Teach-in, offset, tare, min/max value, math. functions, delayed start, simulation
Digital filters	exponential / floating / arithmetic average, rounding
Math functions	polynomial / inverse polynomial / logarithm / exponential / power / root
Linearization	linear interpolation in 100 points
OM Link	company communication interface for operation, setting and update of instruments. (microUSB)
Watch-dog	reset after 500 ms
Calibration	at 25 $^{\circ}$ C and 40 % r.h.

DATA OUTPUT

o. of outputs	1
Type	10/100BaseT
Protocol	Modbus TCP/IP (Slave)
Rate	100 Mbit/s.
Setting	DHCP IPv4 Address Subnet Mask Default Gateway Port

POWER SUPPLY

Power	10...30 VDC/24 VAC, $\pm 10\%$, 2.5 VA, PF ≥ 0.4 , $I_{\text{trip}} < 40$ A/1 ms, isolated Fuse inside (1500mA)
Consumption	< 1.4 W / 1.3 VA

MECHANIC PROPERTIES

Material	PA66, incombustible UL 94 V-0, blue
Dimensions	25 x 79 x 90.5 mm (w x h x d)
Installation	to DIN rail 35 mm wide

OPERATING CONDITIONS

Connection	connector terminal blocks, section < 1.5 mm ²
Stabilization period	within 5 minutes after switch-on
Working temp.	-20...60 $^{\circ}$ C
Storage temp.	-20...85 $^{\circ}$ C
Working humidity	< 95 % r.h., non condensing
Protection	IP20
Construction	safety class I
El. safety	EN 61010-1, A2
Dielectric strength	2.5 kVAC for 1 min. between power supply and signal input 2.5 kVAC for 1 min. between signal input and outputs
Insulation resistance*	for pollution degree II, measurement cat. III power supply > 300 V (PI), 255 V (DI) Input/outputs > 300 V (PI)
EMC	EN 61326-1 (Industrial area)
RoHS	EN IEC 63000:2018
Seismic qualification	IEC/IEEE 60980-344 ed. 1.0:2020, par. 6, 9
Mechanical resistance	EN 60068-2-6 ed. 2:2008

* PI - Primary insulation, DI - Double insulation



On our website www.orbitmerret.eu
Application sheets are available for the products under the "Download support" tab, which provide detailed descriptions of the features, functions or use of the device.



ORBIT MERRET, spol. s r.o.

Vodňanská 675/30
198 00 Praha 9
Czech Republic

+420 - 281 040 200 info@orbitmerret.eu