



# OM 402UNI

---

## 4 DIGIT PROGRAMMABLE UNIVERSAL INSTRUMENT

DC VOLTMETER/AMMETER

PROCESS MONITOR

OHMMETER

THERMOMETER FOR PT 100/500/1 000

THERMOMETER FOR NI 1 000

THERMOMETER FOR THERMOCOUPLES

DISPLAYS FOR LIN. POTENTIOMETERS





## SAFETY INSTRUCTIONS

Please, read the enclosed safety instructions carefully and observe them!  
These instruments should be safeguarded by isolated or common fuses (breakers)  
For safety information the EN 61 010-1 + A2 standard must be observed.  
This instrument is not explosion-safe!

## TECHNICAL DATA

Measuring instruments of the DM 402 series conform to the European regulation 89/336/EWG.

The instruments are up to the following European standards:

EN 61010-1 Electrical safety

EN 61326-1 Electronic measuring, control and laboratory devices – Requirements for EMC "Industrial use"

Seismic capacity:

IEC 980: 1993, čl. 6

The instruments are applicable for unlimited use in agricultural and industrial areas.

## CONNECTION

Supply of energy from the main line has to be isolated from the measuring leads.



## ORBIT MERRET, spol. s r.o.

Vodnanská 675/30  
198 00 Prague 9  
Czech Republic

Tel: +420 - 281 040 200  
Fax: +420 - 281 040 299  
e-mail: orbit@merret.eu  
www.orbit.merret.eu



<b>1. CONTENTS</b> .....	<b>3</b>
<b>2. INSTRUMENT DESCRIPTION</b> .....	<b>4</b>
<b>3. INSTRUMENT CONNECTION</b> .....	<b>6</b>
Measuring ranges .....	6
Termination of RS 485 communication line .....	6
Instrument connection .....	7
Recommended connection of sensors .....	8
<b>4. INSTRUMENT SETTING</b> .....	<b>10</b>
Symbols used in the instructions .....	12
Setting the DP and the {} sign .....	12
Control keys function .....	13
Setting/permitting items into 'USER' menu .....	13
<b>5. SETTING "LIGHT" MENU</b> .....	<b>14</b>
5.0 Description "LIGHT" menu .....	14
Setting input - Type "DC" .....	18
Setting input - Type "PM" .....	20
Setting input - Type "OHM" .....	22
Setting input - Type "RTD - Pt" .....	24
Setting input - Type "RTD - Ni" .....	26
Setting input - Type "T/C" .....	28
Setting input - Type "DU" .....	30
Setting input - Type "RTD - Cu" .....	32
Setting Limits .....	34
Setting analog output .....	36
Selection of programming menu „LIGHT"/„PROFI" .....	38
Restoration of manufacture setting .....	38
Calibration - input range [DU] .....	39
Selection of instrument menu language version .....	40
Setting new access password .....	40
Instrument identification .....	41
<b>6. SETTING "PROFI" MENU</b> .....	<b>42</b>
6.0 Description of "PROFI" menu .....	42
6.1 "PROFI" menu - INPUT .....	
6.1.1 Resetting internal values .....	46
6.1.2 Setting measuring type, range, mode, rate .....	47
6.1.3 Setting the Real Time .....	51
6.1.4 External input function selection .....	51
6.1.5 Optional accessory functions of the keys .....	52
6.2 "PROFI" menu - CHANNEL .....	
6.2.1 Setting measuring parameters (projection, filters, decimal point, description) .....	56
6.2.2 Setting mathematic functions .....	60
6.2.3 Selection of evaluation of min/max. value .....	62
6.3 "PROFI" menu - OUTPUT .....	
6.3.1 Setting data logging .....	64
6.3.2 Setting Limits .....	66
6.3.3 Setting data output .....	69
6.3.4 Setting analog output .....	70
6.3.5 Selection of display projection .....	72
6.4 "PROFI" menu - SERVICE .....	
6.4.1 Selection of programming menu „LIGHT"/„PROFI" .....	74
6.4.2 Restoration manufacture setting .....	75
6.4.3 Calibration - input range [DU] .....	75
6.4.4 Selection of instrument menu language version .....	76
6.4.5 Setting new access password .....	76
6.4.6 Instrument identification .....	77
<b>7. SETTING ITEMS INTO "USER" MENU</b> .....	<b>78</b>
7.0 Configuration "USER" menu .....	78
<b>8. METHOD OF MEASURING OF THE COLD JUNCTION</b> .....	<b>80</b>
<b>9. DATA PROTOCOL</b> .....	<b>81</b>
<b>10. ERROR STATEMENTS</b> .....	<b>82</b>
<b>12. TABLE OF SYMBOLS</b> .....	<b>83</b>
<b>12. TECHNICAL DATA</b> .....	<b>84</b>
<b>13. INSTRUMENT DIMENSIONS AND INSTALATION</b> .....	<b>86</b>
<b>14. CERTIFICATE OF GUARANTEE</b> .....	<b>87</b>
<b>DECLARATION OF CONFORMITY</b> .....	<b>88</b>

## 2. INSTRUMENT DESCRIPTION



### 2.1 DESCRIPTION

The OM 402 model series are 4 digit panel programmable instruments designed for maximum efficiency and user comfort while maintaining their favourable price. Two models are available: UNI and PWR.

Type OM 402UNI is a multifunction instrument with the option of configuration for 8 various input options, easily configurable in the instrument menu. By further options of input modules it is feasible to measure larger ranges of DC voltage and current or increase the number of inputs up to 4 (applies for PM).

The instrument is based on an 8-bit microcontroller with a multichannel 24-bit sigma-delta converter, which secures high accuracy, stability and easy operation of the instrument.

#### TYPES AND RANGES

<b>UNI</b>	DC: 0...60/150/300/1200 mV
	PM: 0...5 mA/0...20 mA/4...20 mA/±2 V/±5 V/±10 V/±40 V
	OHM: 0...100 Ω/0...1 kΩ/0...10 kΩ/0...100 kΩ/Autorange
	RTD-Pt: Pt 50/100/Pt 500/Pt 1000
	RTD-Cu: Cu 50/Cu 100
	RTD-Ni: Ni 1 000/Ni 10 000
	T/C: J/K/T/E/B/S/R/N/L
	DU: Linear potentiometer (min. 500 Ω)
<b>UNI - A</b>	DC: ±0,1 A/±0,25 A/±0,5 A/±2 A/±5 A/±10 V/±250 V/±500 V
<b>UNI - B</b>	PM: 3x 0...5 mA/0...20 mA/4...20 mA/±2 V/±5 V/±10 V/±40 V

#### PROGRAMMABLE PROJECTION

Selection:	of type of input and measuring range
Measuring range:	adjustable as fixed or with automatic change
Setting:	manual, optional projection on the display may be set in the menu for both limit values of the input signal, e.g. input 0...20 mA > 0...850,0
Projection:	-9999...9999 [-99999...999999]

#### COMPENSATION

of conduct:	in the menu it is possible to perform compensation for 2-wire connection
of conduct in probe:	internal connection (conduct resistance in measuring head)
of CJC (T/C):	manual or automatic, in the menu it is possible to perform selection of the type of thermocouple and compensation of cold junctions, which is adjustable or automatic (temperature at the brackets)

#### LINEARIZATION

Linearization:*	by linear interpolation in 50 points (solely via OM Link)
-----------------	---

#### DIGITAL FILTERS

Floating average:	from 2...30 measurements
Exponen. average:	from 2...100 measurements
Arithmetic average:	from 2...100 measurements
Rounding:	setting the projection step for display

#### MATHEMATIC FUCTIONS

Min/max. value:	registration of min./max. value reached during measurement
Tare:	designed to reset display upon non-zero input signal
Peak value:	the display shows only max. or min. value
Mat. operations:	polynome, 1/x, logarithm, exponential, power, root, sin x

\* only for types DC, PM, DU

**EXTERNAL CONTROL**

Lock:	control keys blocking
Hold:	display/instrument blocking
Tare:	tare activation/resetting tare to zero
Resetting MM:	resetting min/max value
Memory:	data storage into instrument memory

**2.2 OPERATION**

The instrument is set and controlled by five control keys located on the front panel. All programmable settings of the instrument are performed in three adjusting modes:

<b>LIGHT</b>	<b>Simple programming menu</b> - contains solely items necessary for instrument setting and is protected by optional number code
<b>PROFI</b>	<b>Complete programming menu</b> - contains complete instrument menu and is protected by optional number code
<b>USER</b>	<b>User programming menu</b> - may contain arbitrary items selected from the programming menu (LIGHT/PROFI), which determine the right (see or change) - access without password

All programmable parameters are stored in the EEPROM memory (they hold even after the instrument is switched off).



Complete instrument operation and setting may be performed via OM Link communication interface, which is a standard equipment of all instruments.

The operation program is freely accessible [[www.orbit.merret.eu](http://www.orbit.merret.eu)] and the only requirement is the purchase of OML cable to connect the instrument to PC. It is manufactured in version RS 232 and USB and is compatible with all ORBIT MERRRET instruments. Another option for connection is with the aid of data output RS 232 or RS 485 (without the need of the OML cable).

The program OM LINK in „Basic“ version will enable you to connect one instrument with the option of visualization and archiving in PC. The OM Link „Standard“ version has no limitation of the number of instruments connected.

**2.3 OPTIONS**

**Excitation** is suitable for supplying power to sensors and transmitters. It has a galvanic separation.

Comparators are assigned to monitor one, two, three or four limit values with relay output. The user may select limits regime: LIMIT/DDSG/FRDM-TD. The limits have adjustable hysteresis within the full range of the display as well as selectable delay of the switch-on in the range of 0...99,9 s. Reaching the preset limits is signalled by LED and simultaneously by the switch-on of the relevant relay.

Data outputs are for their rate and accuracy suitable for transmission of the measured data for further projection or directly into the control systems. We offer an isolated RS232 and RS485 with the ASCII or DIN MessBus protocol.

Analog outputs will find their place in applications where further evaluating or processing of measured data is required in external devices. We offer universal analog output with the option of selection of the type of output - voltage/current. The value of analog output corresponds with the displayed data and its type and range are selectable in Menu.

Measured data record is an internal time control of data collection. It is suitable where it is necessary to register measured values. Two modes may be used. FAST is designed for fast storage (40 records/s) of all measured values up to 8 000 records. Second mode is RTC, where data record is governed by Real Time with data storage in a selected time segment and cycle. Up to 250 000 values may be stored in the instrument memory. Data transmission into PC via serial interface RS232/485 and OM Link.

### 3. INSTRUMENT CONNECTION



The instrument supply leads should not be in proximity of the incoming low-potential signals.

Contactors, motors with larger input power should not be in proximity of the instrument.

The leads into the instrument input (measured quantity) should be in sufficient distance from all power leads and appliances. Provided this cannot be secured it is necessary to use shielded leads with connection to ground (bracket E).

The instruments are tested in compliance with standards for use in industrial area, yet we recommend to abide by the above mentioned principles.

#### MEASURING RANGES

TYPE	INPUT I	INPUT U
DC		0...60/150/300/1 200 mV
PM	0...5/20 mA/4...20 mA	$\pm 2/\pm 5/\pm 10/\pm 40$ V
DHM	0...100 $\Omega$ /1 k $\Omega$ /10 k $\Omega$ /100 k $\Omega$ /Autorange	
RTD-Pt	Pt 50/100/Pt 500/ Pt 1 000	
RTD-Cu	Cu 50/100	
RTD-Ni	Ni 1 000/10 000	
T/C	J/K/T/E/B/S/R/N/L	
DU	Linear potentiometer (min. 500 $\Omega$ )	

#### OPTION "A"

TYPE	INPUT I	INPUT U
DC	$\pm 0,1$ A/ $\pm 0,25$ A/ $\pm 0,5$ to GND [C] $\pm 2$ A/ $\pm 5$ A to GND [B]	$\pm 100$ V/ $\pm 250$ V/ $\pm 500$ V to GND [C]

#### OPTION "B"

TYPE	INPUT 2, 3, 4/I	INPUT 2, 3, 4/U
PM	0...5/20 mA/4...20 mA	$\pm 2/\pm 5/\pm 10/\pm 40$ V

#### Termination of RS 485 communication line

##### X3 - Termination of communication line RS 485

Full	Significance	Default	Recommendation
1-2	connect L+ to (+) source	terminalconnected	connect at the end of line do not disconnect
3-4	termination of line 120 Ohm	disconnected	
5-6	connect L- to (-) source	terminalconnected	

RS 485 line should have a linear structure - wires (ideally shielded and twisted) should lead from one device to another.

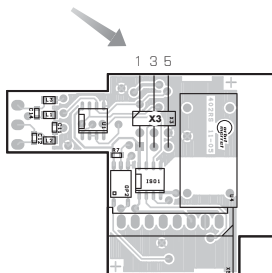

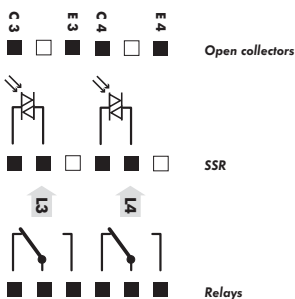

**!**  
Excitation has the minus pole common with the input - the bracket no. 20 - GND and you may set its value by trimmer above the bracket no. 17

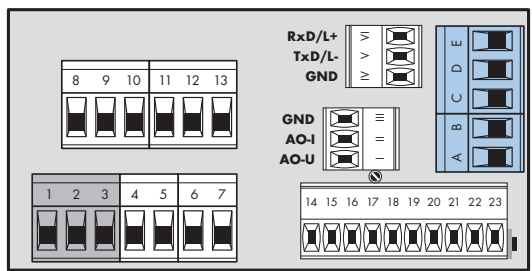

- Option A**
- INPUT - U
  - GND - U/10,5
  - GND - 15
  - INPUT - I

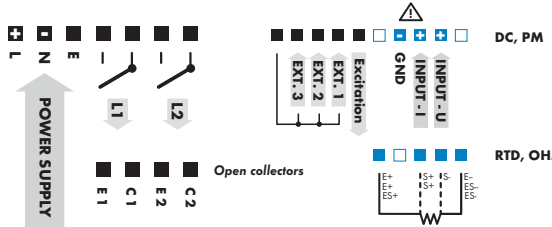

Maximum of 250 mA may be connected to "INPUT - I" (bracket no. 21), i.e. 10-times range overload. Mind the correct connection/mistaking of current - voltage input. Destruction of measuring resistance in current input (15R) may occur.

### 3. INSTRUMENT CONNECTION



Example connection of a 2-wire sensor with current signal output powered by instrument's excitation

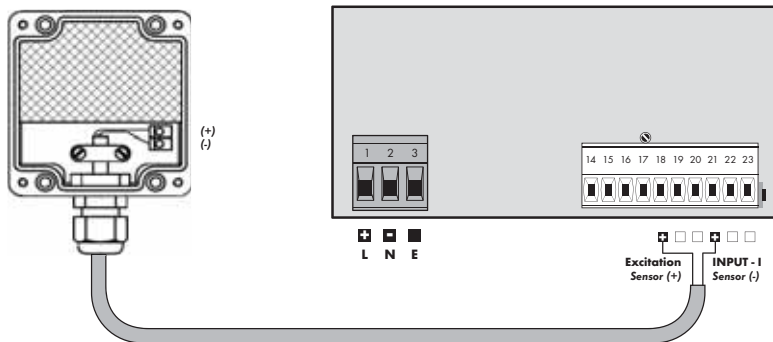

Example connection of a 3-wire sensor with current signal output powered by instrument's excitation

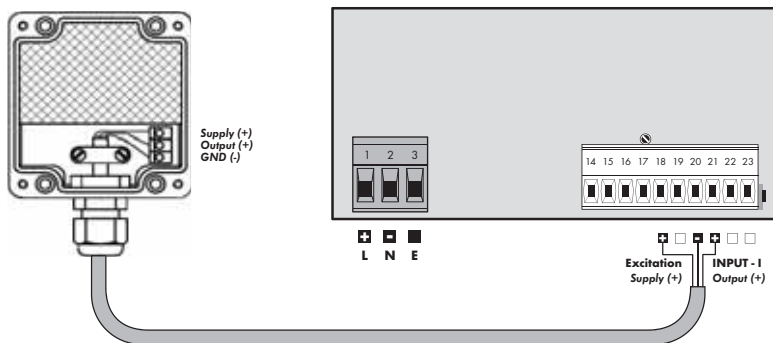



Example connection of 3-wire sensor with voltage signal output powered by instrument's excitation

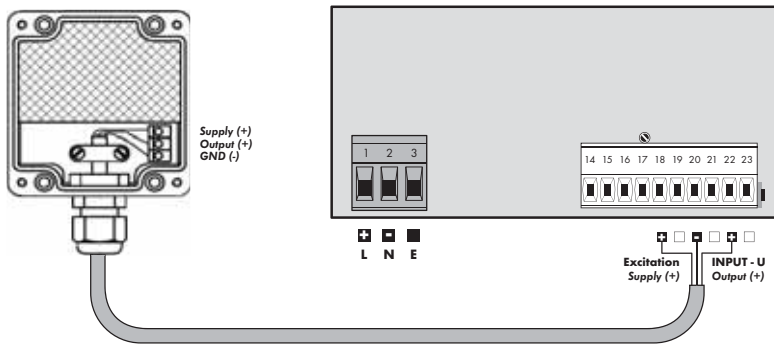

Example connection of resistance measurement using 4 wires

By connecting resistor  $R^*$  we eliminate error message E. I.Ov. (input overflow) when the measured resistance is disconnected

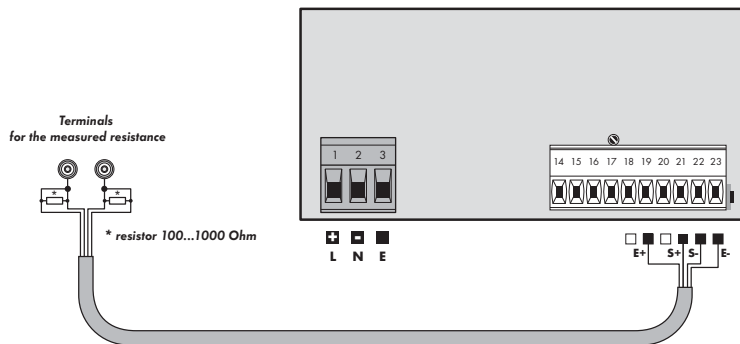



## SETTING **PROFI**

For expert users

Complete instrument menu

Access is password protected

Possibility to arrange items of the **USER MENU**

Tree menu structure

## SETTING **LIGHT**

For trained users

Only items necessary for instrument setting

Access is password protected

Possibility to arrange items of the **USER MENU**

Linear menu structure

## SETTING **USER**

For user operation

Menu items are set by the user (Profi/Light) as per request

Access is not password protected

Optional menu structure either tree (PROFI) or linear (LIGHT)

## 4.1 SETTING

The instrument is set and controlled by five control keys located on the front panel. All programmable settings of the instrument are performed in three adjusting modes:

- LIGHT**      **Simple programming menu**  
- contains solely items necessary for instrument setting and is protected by optional number code
- PROFI**      **Complete programming menu**  
- contains complete instrument menu and is protected by optional number code
- USER**        **User programming menu**  
- may contain arbitrary items selected from the programming menu (LIGHT/PROFI), which determine the right (see or change)  
- acces without password

All programmable parameters are stored in the EEPROM memory (they hold even after the instrument is switched off).

Complete instrument operation and setting may be performed via QM Link communication interface, which is a standard equipment of all instruments.

The operation program is freely accessible ([www.orbit.merret.eu](http://www.orbit.merret.eu)) and the only requirement is the purchase of QML cable to connect the instrument to PC. It is manufactured in version RS 232 and USB and is compatible with all ORBIT MERRET instruments. Another option for connection is with the aid of data output RS 232 or RS 485 (without the need of the QML cable).

## Scheme of processing the measured signal

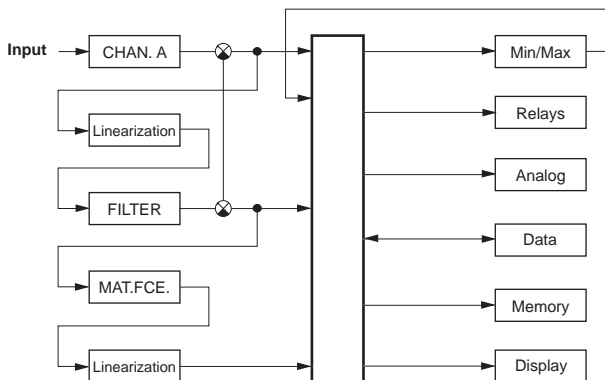

## 4. INSTRUMENT SETTING

Setting and controlling the instrument is performed by means of 5 control keys located on the front panel. With the aid of these keys it is possible to browse through the operation menu and to select and set required values.

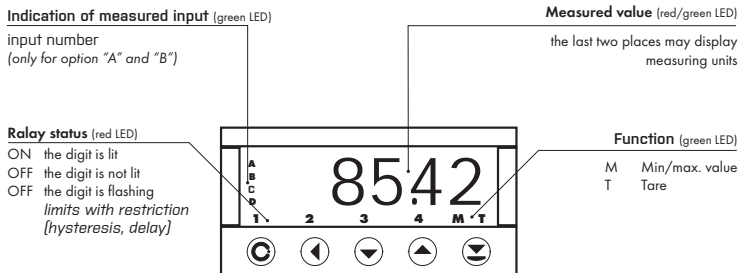

### Symbols used in the instructions

**DC** **PM**  
**DU** **OHM** **RTD** **T/C** Indicates the setting for given type of instrument

**DEF** values preset from manufacture

symbol indicates a flashing light (symbol)

**MIN** inverted triangle indicates the item that can be placed in USER menu

**CONNECT** broken line indicates a dynamic item, i.e. it is displayed only in particular selection/version

after pressing the key the set value will not be stored

after pressing the key the set value will be stored

30 continues on page 30

### Setting the decimal point and the minus sign

#### DECIMAL POINT

Its selection in the menu, upon modification of the number to be adjusted it is performed by the control key with transition beyond the highest decade, when the decimal point starts flashing. Positioning is performed by

#### THE MINUS SIGN

Setting the minus sign is performed by the key on higher decade. When editing the item subtraction must be made from the current number [e.g.: 013 > , on class 100 > -87]

## Control keys functions

KEY	MEASUREMENT	MENU	SETTING NUMBERS/SELECTION
	access into USER menu	exit menu	quit editing
	programmable key function	back to previous level	move to higher decade
	programmable key function	move to previous item	move down
	programmable key function	move to next item	move up
	programmable key function	confirm selection	confirm setting/selection
			numeric value is set to zero
	access into LIGHT/PROFI menu		
	direct access into PROFI menu		
		configuration of an item for "USER" menu	
		determine the sequence of items in "USER - LIGHT" menu	

## Setting items into „USER" menu

- in **LIGHT** or **PROFI** menu
- no items permitted in **USER** menu from manufacture
- on items marked by inverted triangle

## USER

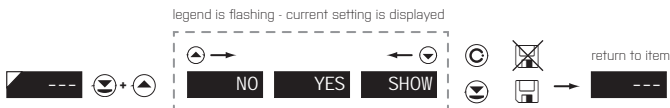

<b>NO</b>	item will not be displayed in USER menu
<b>YES</b>	item will be displayed in USER menu with the option of setting
<b>SHOW</b>	item will be solely displayed in USER menu



## SETTING **LIGHT**

For trained users

Only items necessary for instrument setting

Access is password protected

Possibility to arrange items of the **USER MENU**

Linear menu structure

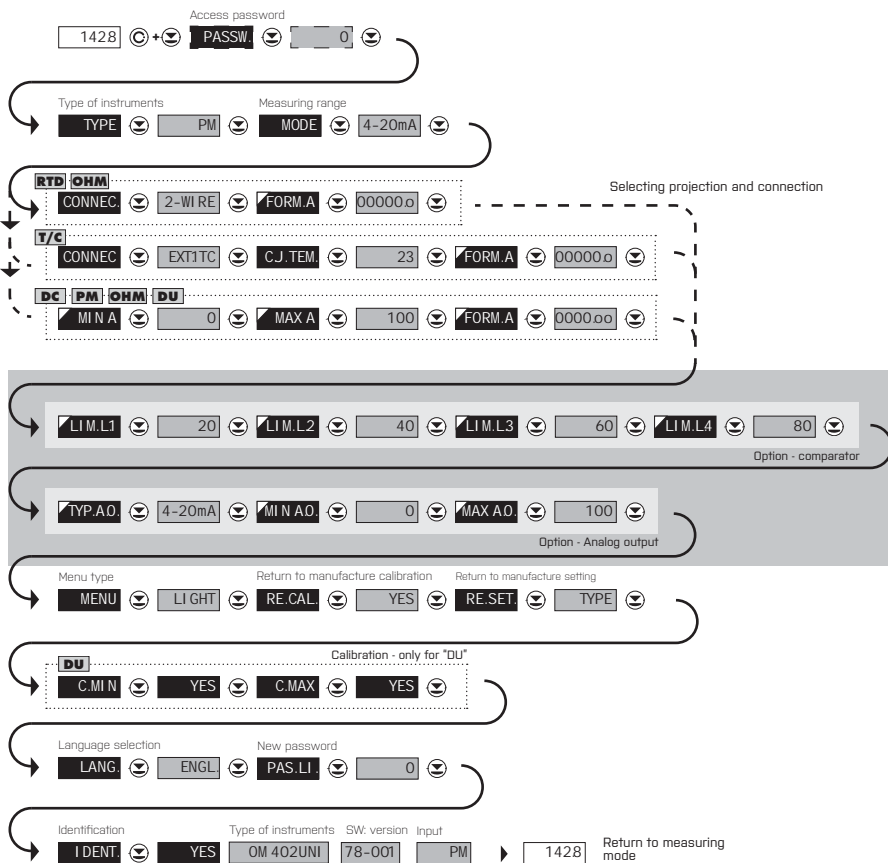

## Preset from manufacture

Password	"0"
Menu	LIGHT
USER menu	off
Setting the items	<b>DEF</b>



Upon delay exceeding 60 s the programming mode is automatically discontinued and the instrument itself restores the measuring mode

## 5. SETTING LIGHT

1428



PASSW

0

Entering access password for access into the menu

**PASSW.** Access into instrument menu

**PAS = 0**

- access into menu is unrestricted, after releasing keys you automatically move to first item of the menu

**PAS > 0**

- access into menu is protected by number code

Set "Password" = 42 Example

0 1 2 02 12 22

32 42 TYPE

TYPE

DC PM OHM RTD- Pt RTD-Ni TC

DU RTD- Cu

**TYPE** Selection of the type of instrument

- primary selection of the type of instrument
- performs default setting **DEF** of values from manufacture, incl. calibration
- **DEF** = „PM“

Menu	Type of instrument
DC	DC voltmeter
PM	Process monitor
OHM	Ohmmeter
RTD-Pt	Thermometer for sensors Pt
RTD-Ni	Thermometer for sensors Ni
TC	Thermometer for thermocouples
DU	Display for lin. potentiometer
RTD-Cu	Thermometer for sensors Cu

Type "PM" Example

DC PM MODE

Type „DC“	18
Type "PM"	20
Type "OHM"	22
Type "RTD-Pt"	24
Type "RTD-Ni"	26
Type "TC"	28
Type "DU"	30
Type "RTD-Cu"	32





## 5. SETTING PROFI

MEASURING MODE > DC

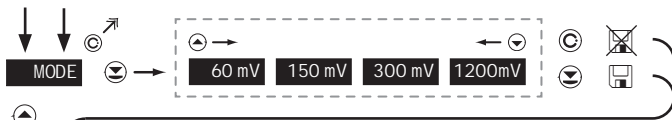

**MODE** Selection of the instrument measuring range

**DEF** = 60 mV

**DEF** = 500 V\*

\* only for option "A"

Menu	Measuring range
60 mV	±60 mV
150 mV	±150 mV
300 mV	±300 mV
1200mV	±12 V
100 V	±100 V
250 V	±250 V
500 V	±500 V
0.10 A	±0.1 A
0.25 A	±0.25 A
0.50 A	±0.5 A
1.00 A	±1 A
5.00 A	±5 A

Range ±150 mV Example

60 mV  150 mV  MIN A



**MIN A** Setting display projection for minimum value of input signal

- range of the setting: -99999..999999
- position of the DP does not affect display projection

- the DP is automatically shifted after the value is confirmed

**DEF** = 0

Projection for 0 mV > MIN A = 0 Example

MAX A



**MAX A** Setting display projection for maximum value of input signal

signal

- range of the setting: .99999...999999
- position of the DP does not affect display projection

- the DP is automatically shifted after the value is confirmed

**DEF** = 100

Projection for 150 mV > MAX A = 3500 Example

100	100	100	200	300	400
500	0500	1500	2500	3500	FORM.A

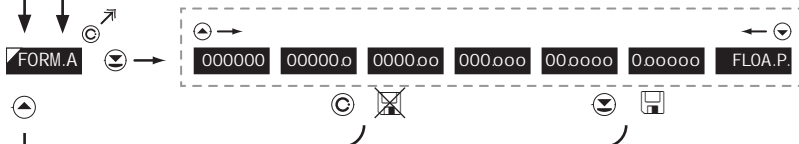

**FORM.A** Setting projection of the decimal point

- positioning of the DP is set here in the measuring mode

**DEF** = 0000.00

Projection of DP on display > 00000.0 Example

0000.00	00000.0	MENU
---------	---------	------

\*subsequent item on the menu depends on instrument equipment

## 5. SETTING LIGHT

MEASURING MODE > PM

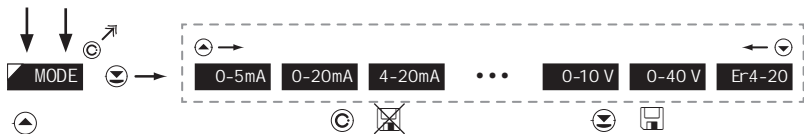

**MODE** Selection of the instrument measuring range

**DEF** = 4 - 20 mA

Menu	Measuring range
0-5mA	0...5 mA
0-20mA	0...20 mA
4-20mA	4...20 mA
0-2 V	±2 V
0-5 V	±5 V
0-10 V	±10 V
0-40 V	±40 V
Er4-20	4...20 mA, with error statement of „underfl ow“ upon signal smaller than 3,36 mA

Range 0...20 mA Example

4-20mA 0-20 mA MIN A



**MIN A** Setting display projection for minimum value of input signal

- range of the setting: -99999...99999
- position of the DP does not affect display projection

- the DP is automatically shifted after the value is confirmed

**DEF** = 0

Projection for 0 mA > MIN A = -25 Example

0 1 2 3 4 5  
 0.5 1.5 2.5 3.5 4.5 5.5  
 MAX A



**MAX A** Setting display projection for maximum value of input signal

- the DP is automatically shifted after the value is confirmed
- range of the setting: -99999...999999
- position of the DP does not affect display projection

**DEF** = 100

Projection for 20 mA > MAX A = 2500 Example

100	100	100	200	300	400
500	0500	1500	2500	FORM.A	

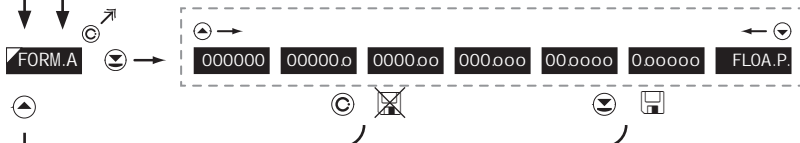

**FORM.A** Setting projection of the decimal point

- positioning of the DP is set here in the measuring mode

**DEF** = 0000.00

Projection of DP on display > 00000.0 Example

0000.00	00000.0	MENU
---------	---------	------

\*subsequent item on the menu depends on instrument equipment

## 5. SETTING LIGHT

MEASURING MODE > OHM

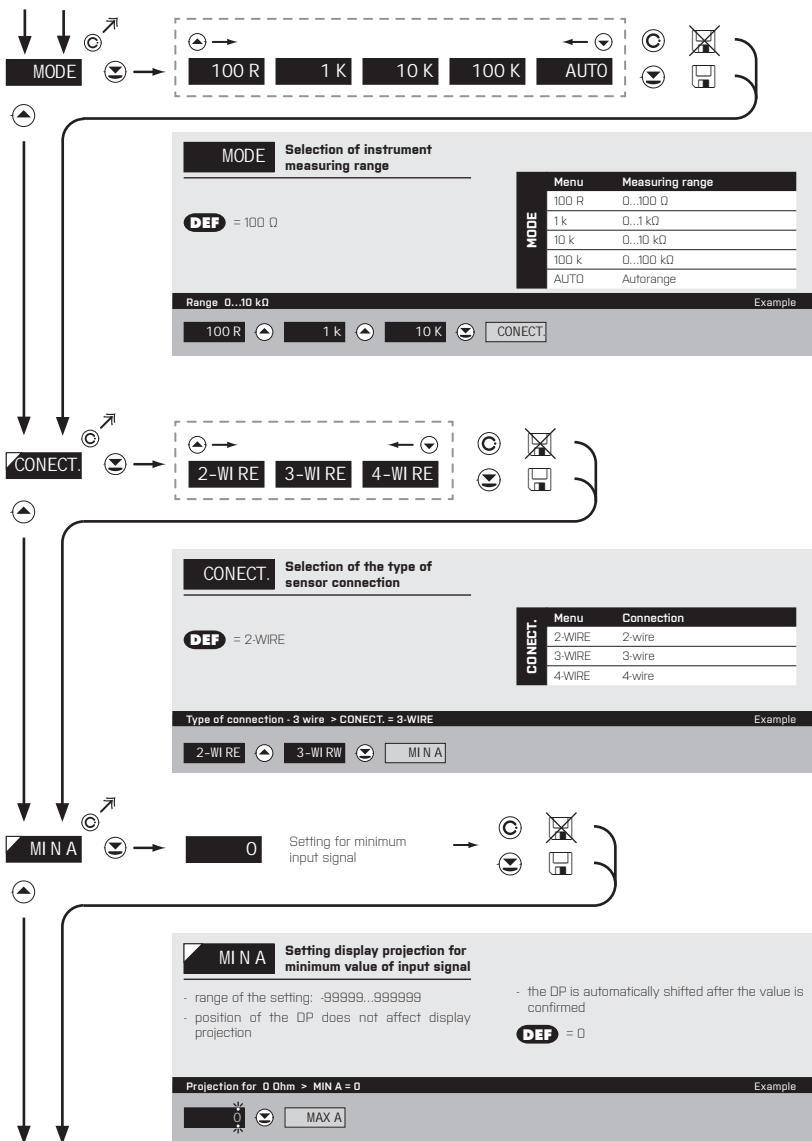



**MAX A** Setting display projection for maximum value of input signal

- range of the setting: -99999...999999
- position of the DP does not affect display projection

- the DP is automatically shifted after the value is confirmed  
**DEF** = 100

Projection for 10 kOhm > MAX A = 10000 Example

100 100 100 000 0000 00000

10000 FORM.A



**FORM.A** Setting projection of the decimal point

- positioning of the DP is set here in the measuring mode

**DEF** = 0000.00

Projection of DP on display > 00000.0 Example

0000.00 00000.0 MENU

\*subsequent item on the menu depends on instrument equipment

## 5. SETTING LIGHT

MEASURING MODE > RTD - Pt

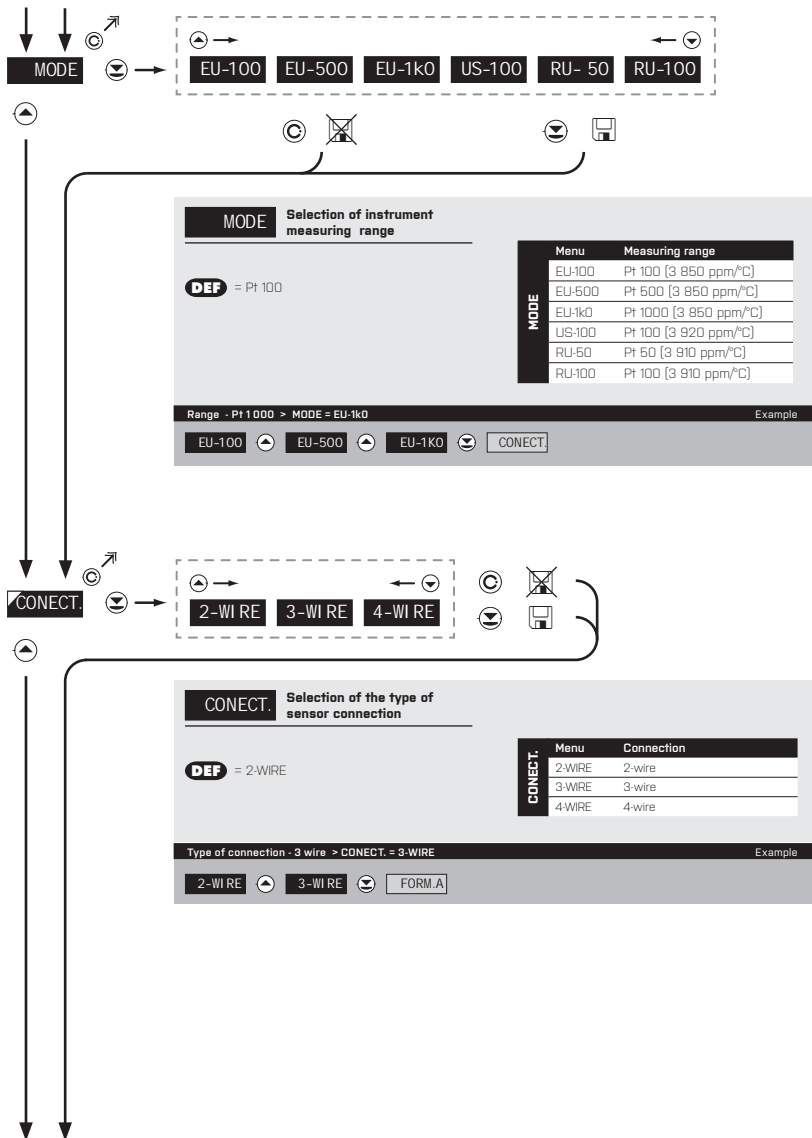



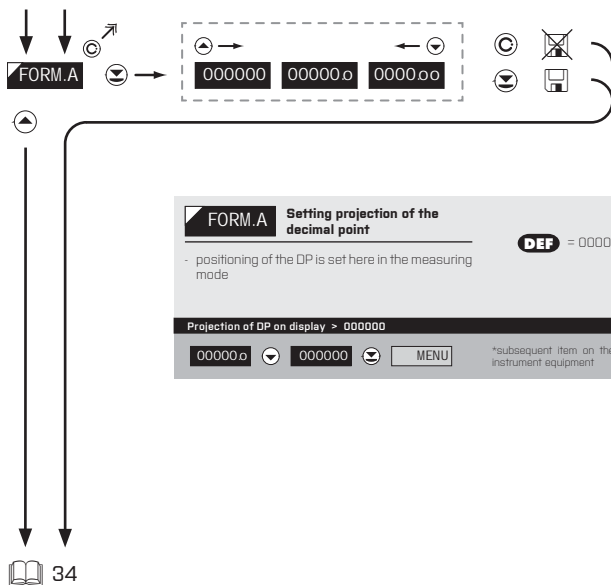

## 5. SETTING LIGHT

MEASURING MODE > RTD - Ni

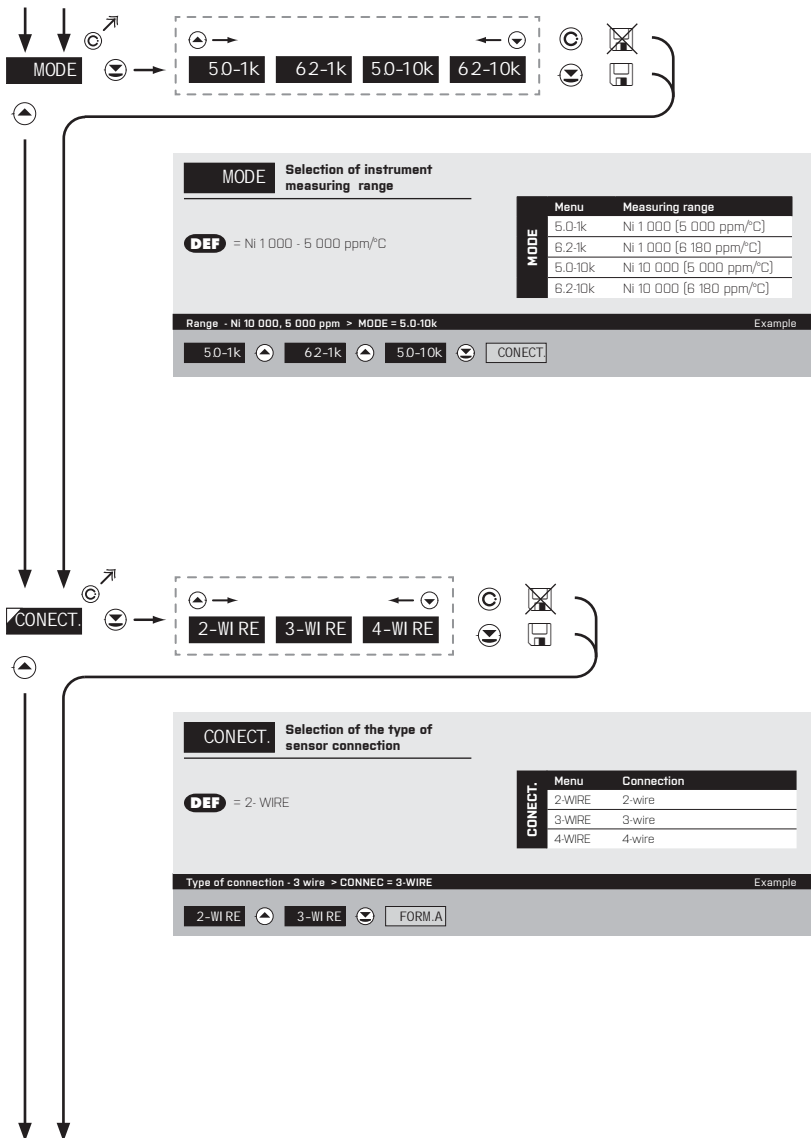

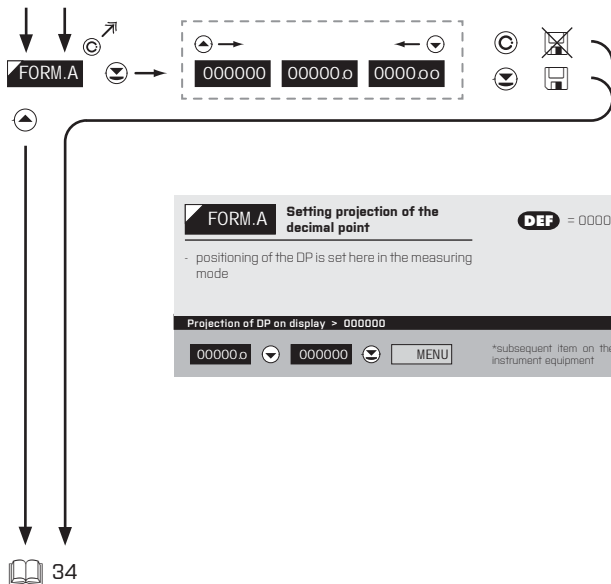

## 6. SETTING PROFI

MEASURING MODE > T/C

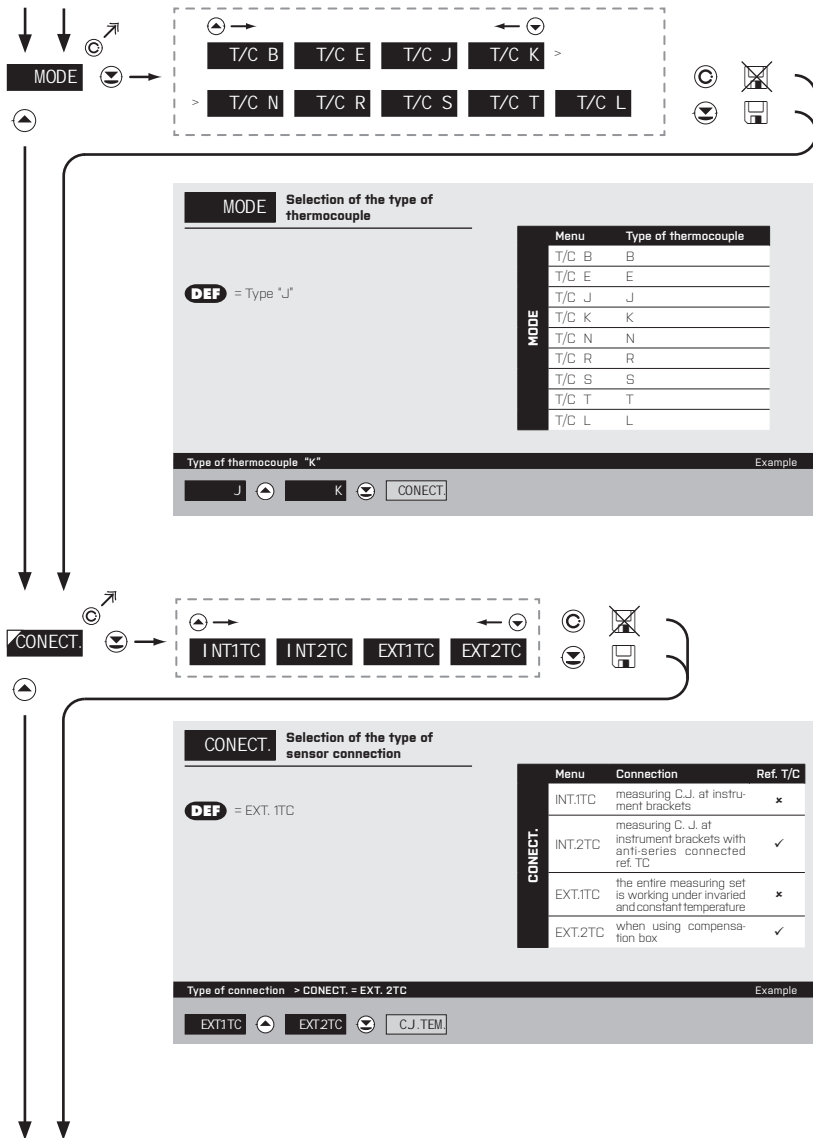

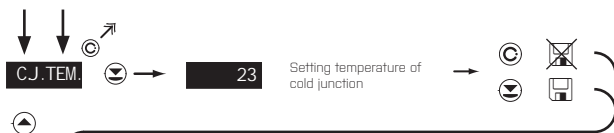

**CJ.TEM.** Setting temperature of cold junction

- range 0...99°C with compensation box

**DEF** = 23

Setting temperature of cold junction > C.J. TEM. = 35 Example

23 24 25 25 35 FORM.A



**FORM.A** Setting projection of the decimal point

- positioning of the DP is set here in the measuring mode

**DEF** = 00000.0

Projection of DP on display > 000000 Example

00000.0 000000 MENU \*subsequent item on the menu depends on instrument equipment

**!** For thermocouple type "B" the items **CONNECT.** and **C.J. TEM.** are not available

**!** Method and procedure of setting the cold junctions is described in separate chapter on page 80

## 5. SETTING LIGHT

MEASURING MODE > DU



**MIN A** **Setting display projection for minimum value of input signal**

- range of the setting: -99999...999999
- position of the DP does not affect display projection

- the DP is automatically shifted after the value is confirmed

**DEF** = 0

Projection for the beginning > MIN A = 0 Example



**MAX A** **Setting display projection for maximum value of input signal**

- range of the setting: -99999...999999
- position of the DP does not affect display projection

- the DP is automatically shifted after the value is confirmed

**DEF** = 100

Projection for the end > MAX A = 5000 Example

FORM.A

000000 00000.0 0000.00 000.000 00.0000 0.00000 FLOA.P.

FORM.A **Setting projection of the decimal point**

DEF = 0000.00

- positioning of the DP is set here in the measuring mode

Projection of DP on display > 0000.00 Example

0000.00 MENU \*subsequent item on the menu depends on instrument equipment

34 Calibration of the beginning and the end of range of linear potentiometer is on page 39

## 5. SETTING LIGHT

MEASURING MODE > RTD - Cu

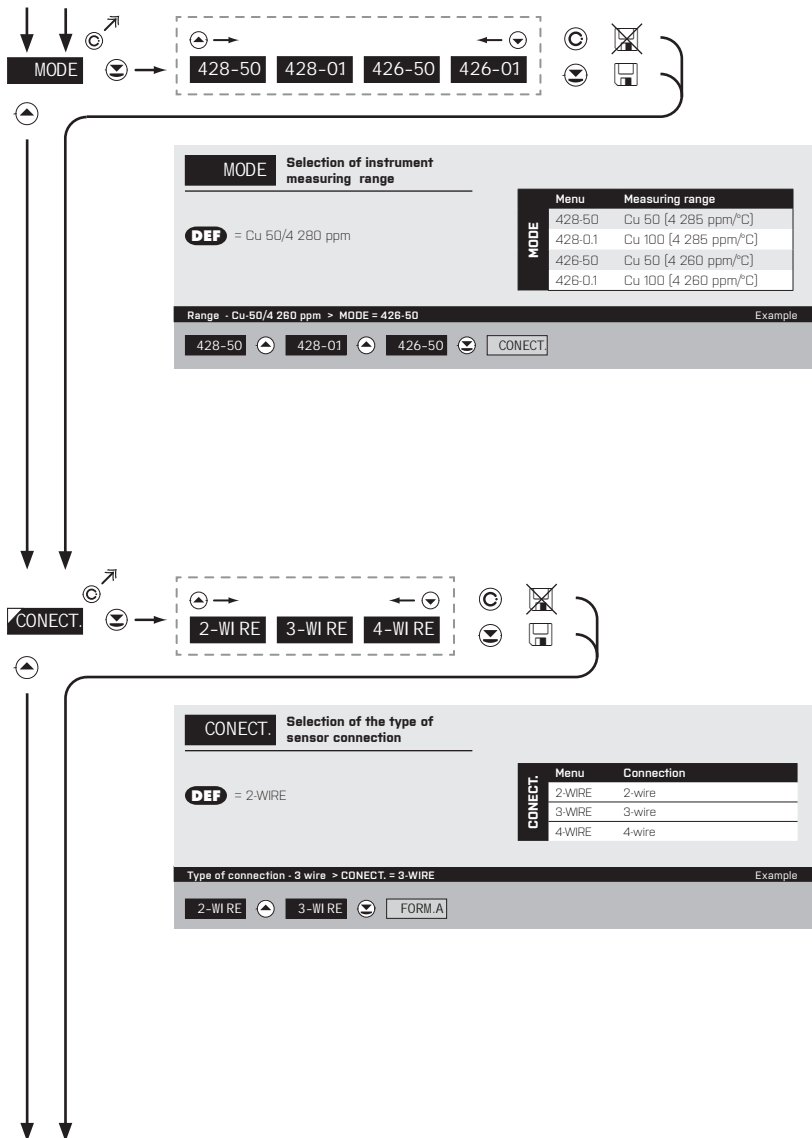



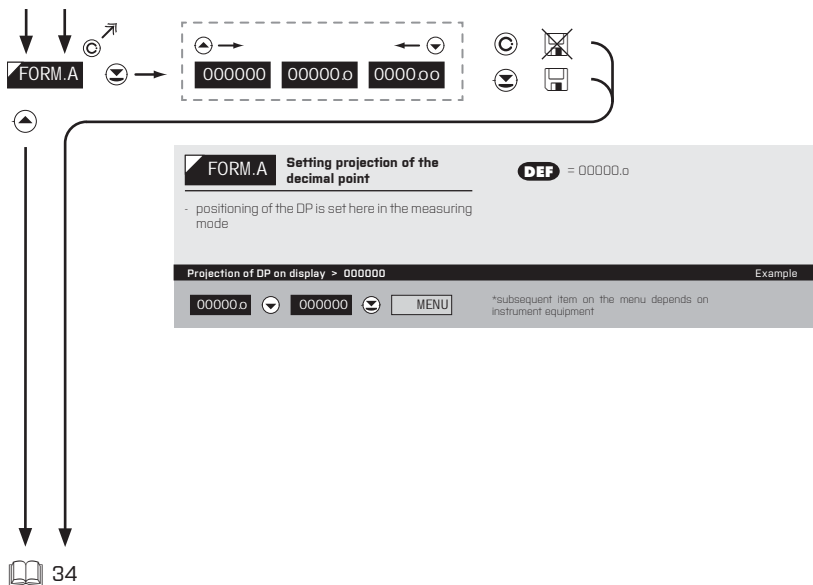

## 5. SETTING LIGHT

DISPLAYED ONLY WITH OPTIONS > COMPARATORS

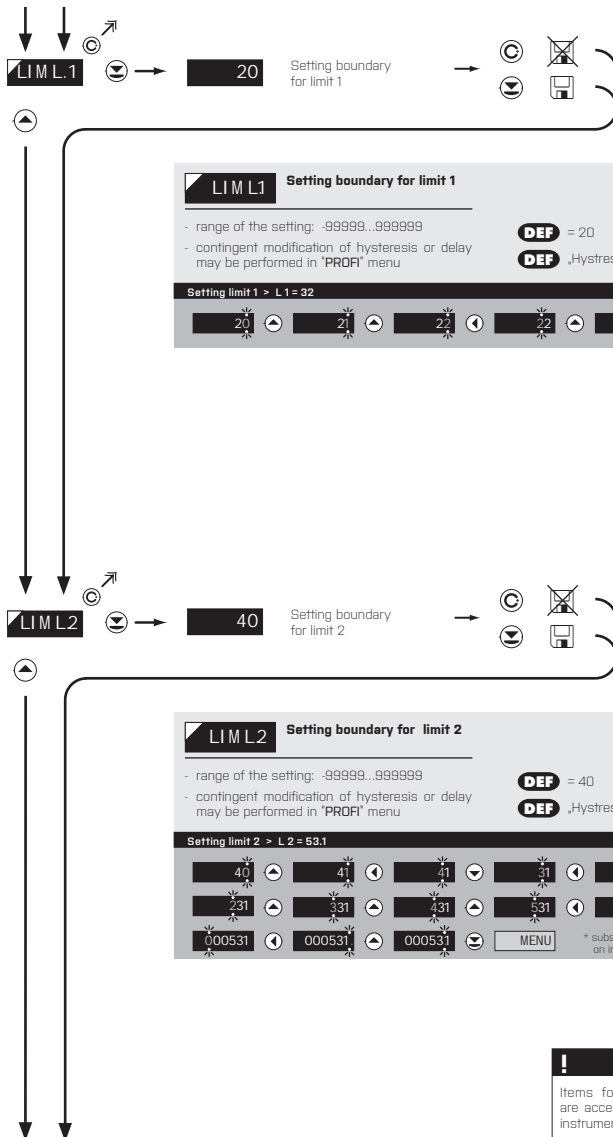

**!**  
Items for "Limits" and "Analog output" are accessible only if incorporated in the instrument.

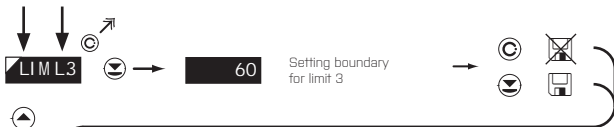

**LIM L3** Setting boundary for limit 3

- range of the setting: -99999...999999
- contingent modification of hysteresis or delay may be performed in 'PROF' menu

**DEF** = 60  
**DEF** „Hysteresis“=0, „Delay“=0

Setting limit 3 > L 3 = 85						Example
60	61	62	63	64	65	
65	75	85	MENU	* subsequent item on the menu depends on instrument equipment		



**LIM L4** Setting boundary for limit 4

- range of the setting: -99999...999999
- contingent modification of hysteresis or delay may be performed in 'PROF' menu

**DEF** = 80  
**DEF** „Hysteresis“=0, „Delay“=0

Setting limit 4 > L 4 = 103						Example
80	81	82	83	83	93	
03	003	103	MENU	* subsequent item on the menu depends on instrument equipment		

## 5. SETTING LIGHT

DISPLAYED ONLY WITH OPTIONS > ANALOG OUTPUT

**TYP.A.O.** [Up] [Down] [Left] [Right] [Enter] [Exit]

0-20mA Er4-T 4-20 T Er4-20 ... 0-10 V +10 V

**TYP.A.O. Setting the type of analog output**

Menu	Range	Description
0-20mA	0...20 mA	
Er4-T	4...20 mA	with error message indication and broken loop indication (<3,6 mA)
4-20T	4...20 mA	with broken loop indication (<3,6 mA)
Er4-20	4...20 mA	with indication of error statement (<3,6 mA)
4-20mA	4...20 mA	
0.5mA	0...5 mA	
0.2 V	0...2 V	
0.5 V	0...5 V	
0-10 V	0...10 V	
+10 V	±10 V	

**DEF** = 4...20 mA

Type of analog output - 0...10 V > TYP. A.O. = 0-10 V Example

4-20mA [Up] 0-5mA [Up] 0-2 V [Up] 0-5 V [Up] 0-10 V [Down] MIN.A.O.

**MIN.A.O.** [Up] [Down] [Left] [Right] [Enter] [Exit]

0 Assigning the display value to the beginning of the AD range → [Up] [Down] [Left] [Right] [Enter] [Exit]

**MIN.A.O. Assigning the display value to the beginning of the AD range** **DEF** = 0

range

- range of the setting: -99999...999999

Display value for the beginning of the AD range > MIN.A.O. = 0 Example

0 [Up] [Down] [Left] [Right] [Enter] [Exit] MAX.A.O.

**!**

Items for "Limits" and "Analog output" are accessible only if incorporated in the instrument.



**MAX A.D.** Assigning the display value to the end of the AD range

- range of the setting: -99999...999999 **DEF** = 100

Display value for the end of the AD range > MAX A.D. = 120 Example

100 ← 100 → 110 → 120 ↓ MENU

DISPLAYED ONLY WITH OPTIONS > ANALOG OUTPUT

## 5. SETTING LIGHT

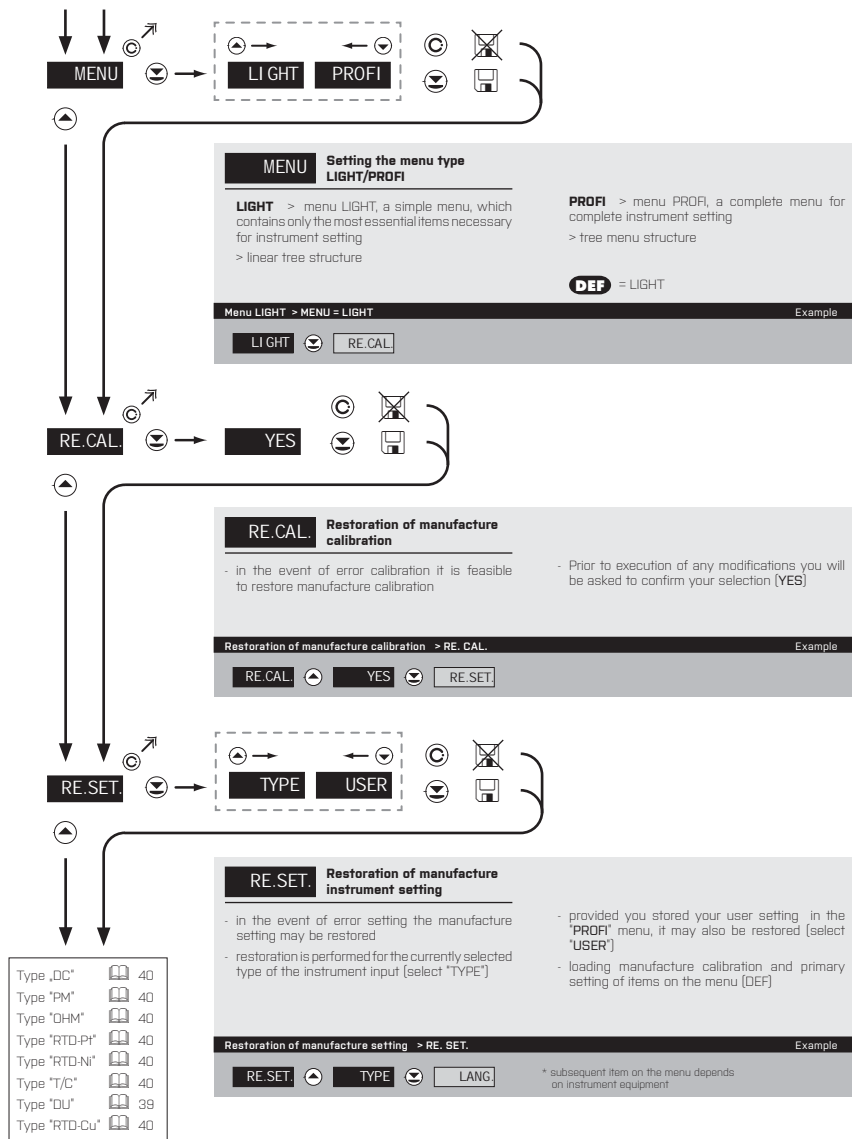

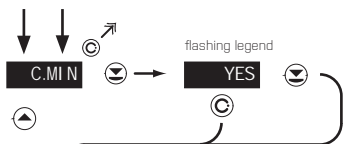

<b>C.MIN</b>	<b>Calibration of input range - the potentiometer traveller in initial position</b>	Only for type "DU"
- prior confirming the flashing "YES" sign the potentiometer traveller has to be in given idle position		
<b>Calibration of the beginning of the range &gt; C. MIN</b>		Example
<b>YES</b>	<input type="text" value="C.MAX"/>	

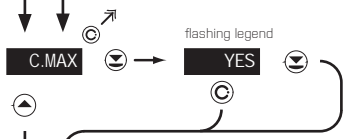

<b>C.MAX</b>	<b>Calibration of input range - the potentiometer traveller in end position</b>	Only for type "DU"
- prior confirming the flashing "YES" sign the potentiometer traveller has to be in given idle position		
<b>Calibration of the end of the range &gt; C. MAX</b>		Example
<b>YES</b>	<input type="text" value="LANG"/>	

## 5. SETTING LIGHT

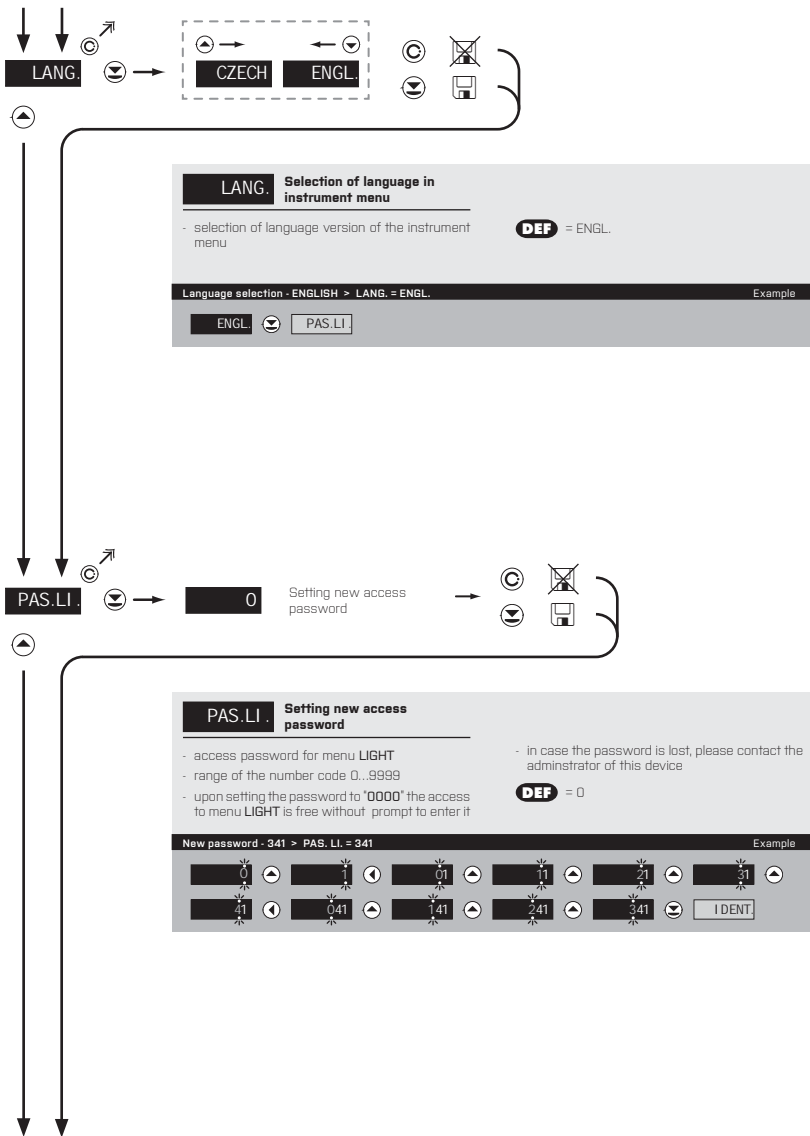



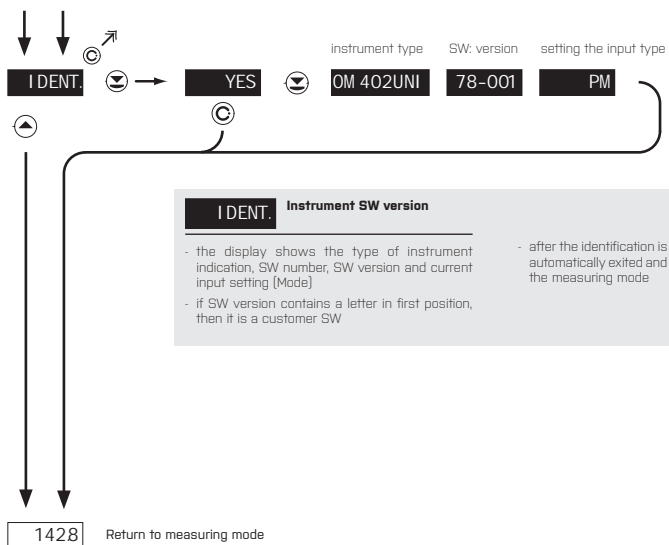



# SETTING **PROFI**

For expert users

Complete instrument menu

Access is password protected

Possibility to arrange items of the **USER MENU**

Tree menu structure

### 6.0

#### SETTING "PROFI"

#### **PROFI**

##### **Complete programming menu**

- contains complete instrument menu and is protected by optional number code
- designed for expert users
- preset from manufacture is menu **LIGHT**

#### Switching over to "PROFI" menu



- access to **PROFI** menu
- authorization for access to **PROFI** menu does not depend on setting under item **SERVIC. > MENU**
- password protected access (unless set as follows under the item **SERVIC. > N. PASS. > PROFI =0**)



- access to menu selected under item **SERVIC. > MENU > LIGHT/PROFI**
- password protected access (unless set as follows under the item **SERVIC. > N. PASS. > LIGHT =0**)
- for access to **LIGHT** menu passwords for **LIGHT** and **PROFI** menu may be used



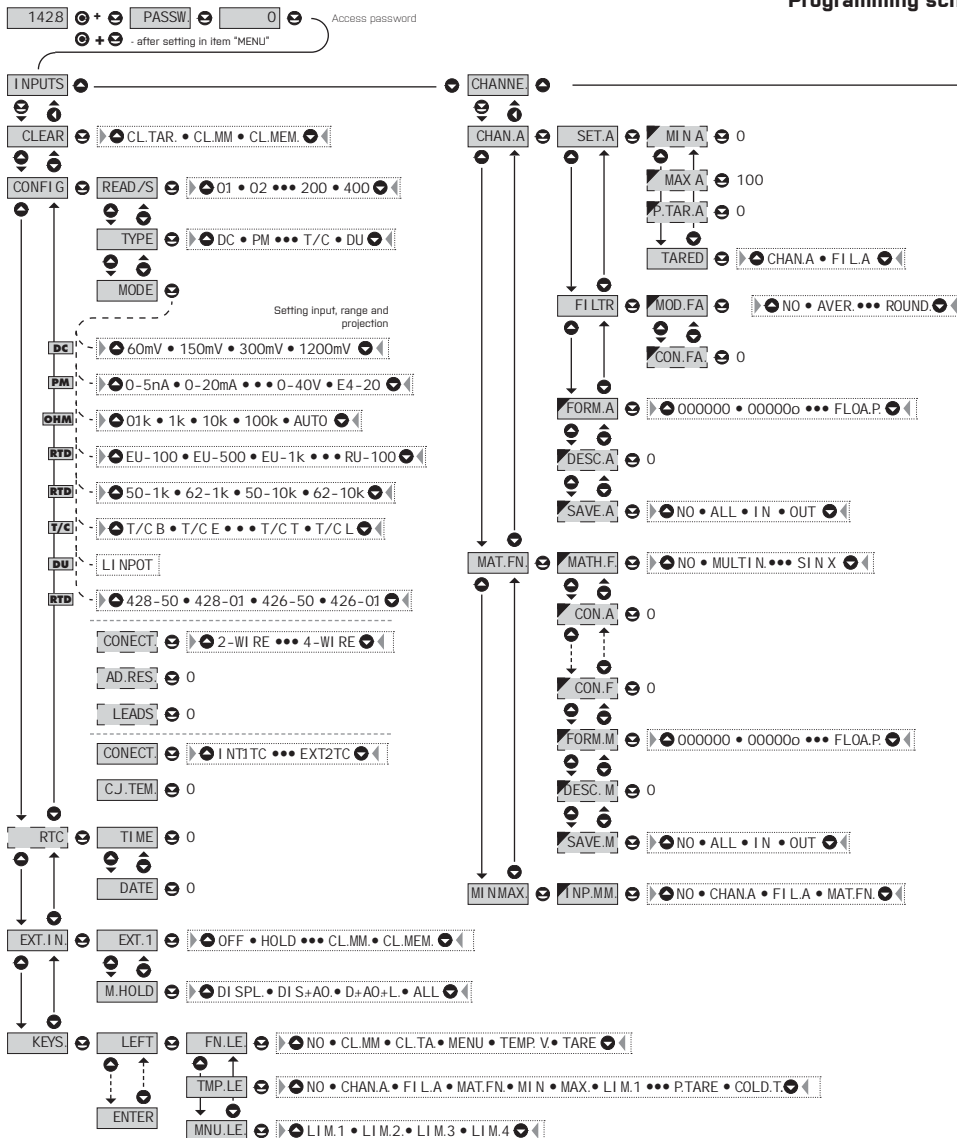

## HOME PROFI MENU

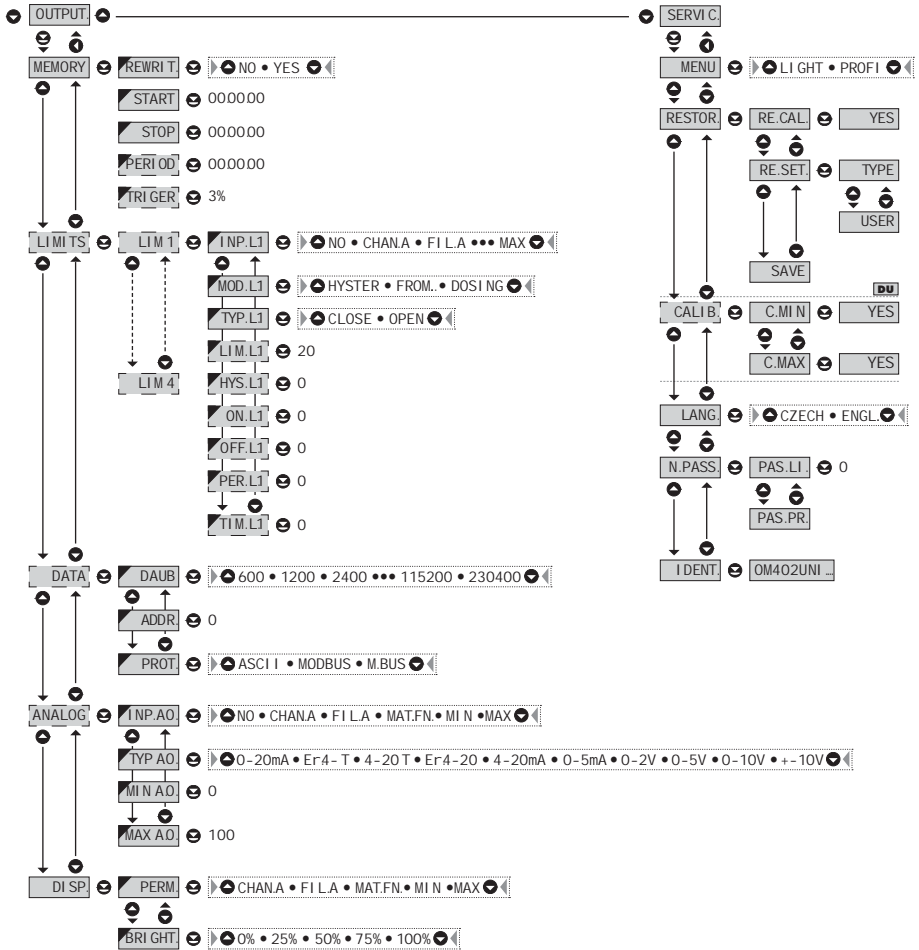

**!**  
Upon delay exceeding 60 s the programming mode is automatically discontinued and the instrument itself restores the measuring mode

## 6. SETTING PROFI

### 6.1 SETTING "PROFI" - INPUT

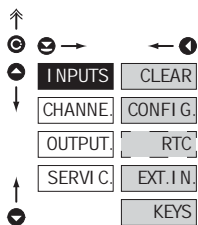

The primary instrument parameters are set in this menu

<b>CLEAR</b>	Resetting internal values
<b>CONFIG.</b>	Selection of measuring range and parameters
<b>RTC</b>	Setting date and time for option with RTC
<b>EXT.IN.</b>	Setting external inputs functions
<b>KEYS</b>	Assigning further functions to keys on the instrument

### 6.1.1 RESETTING INTERNAL VALUES

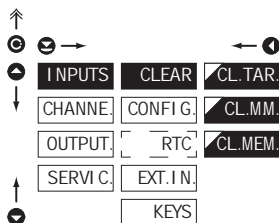

**CLEAR** Resetting internal values

<b>CL.TAR.</b>	Tare resetting
<b>CL.MM.</b>	Resetting min/max value
- resetting memory for the storage of minimum and maximum value achieved during measurement	
<b>CL.MEM.</b>	Resetting the instrument memory
- resetting memory with data measured in the "FAST" or "RTC" modes	
- not in standard equipment	

## 6.1.2a SELECTION OF MEASURING RATE

↑	⊖	→		←	⊕
⊖	INP.U.T.S.	CLEAR	READ/S	40.0	
⊕	CHANNE.	CONF.I.G.	TYPE	20.0	
↓	OUTPUT.	RTC	MODE	10.0	
	SERVIC.	EXT.I.N.	CONECT.	5.0	DEF
		KEYS	C.J.TEM.	2.0	
			AD.RES.	1.0	
			LEADS	0.5	
				0.2	
				0.1	
↑	⊖				

## READ/S Selection of measuring rate

40.0	40,0 measurements/s
20.0	20,0 measurements/s
10.0	10,0 measurements/s
5.0	5,0 measurements/s
2.0	2,0 measurements/s
1.0	1,0 measurement/s
0.5	0,5 measurements/s
0.2	0,2 measurements/s
0.1	0,1 measurements/s

## 6.1.2b SELECTION OF „INSTRUMENT“ TYPE

↑	⊖	→		←	⊕
⊖	INP.U.T.S.	CLEAR	READ/S	DC	
⊕	CHANNE.	CONF.I.G.	TYPE	PM	DEF
↓	OUTPUT.	RTC	MODE	OHM	
	SERVIC.	EXT.I.N.	CONECT.	RTD-Pt	
		KEYS	C.J.TEM.	RTD-Ni	
			AD.RES.	TC	
			LEADS	DU	
				RTD-Cu	
↑	⊖				

## TYPE Selection of „instrument“ type

- selection of particular type of "instrument" is bound to relevant dynamic items

DC	DC voltmeter
PM	Process monitor
OHM	Ohmmeter
RTD-Pt	Thermometer for Pt xxxx
RTD-Ni	Thermometer for Ni xxxx
TC	Thermometer pro thermocouples
DU	Display for linear potentiometers
RTD-Cu	Thermometer for Cu xxx

## 6. SETTING PROFI

### 6.1.2c SELECTION OF MEASURING RANGE

↑

⊖ →

⊕ ←

↓

INP.U.T.S
CLEAR
READ./S
DC
OHM

CHANNE.
CONF.I.G.
TYPE
60mV
100 R

OUTPUT
RTC
MODE
150mV
1 k

SERVIC.
EXT.I.N.
CONNECT.
300mV
10 k

KEYS
C.J.TEM.
AD.RES.
1200mV
100 k

LEADS
DC - A
PM

100 V
0-5mA

250 V
0-20mA

500 V
4-20mA

010 A
0-2 V

025 A
0-5 V

050 A
0-10 V

100 A
0-40 V

500 A
Er4-20

RTD-Pt
RTD-Cu

EU-100
428-50

EU-500
428-01

EU-1k0
426-50

US-100
426-01

RU-50

RU-100

T/C

T/C B

T/C E

T/C J

T/C K

T/C N

T/C R

T/C S

T/C T

T/C L

DU

LI NPOT.

**!**

Switching in the mode  
AUTO - "OHM"

0.1 Ω > 1 kΩ	0.01 k
1 kΩ > 10 kΩ	1.010 k
10 kΩ > 100 kΩ	10.10 k
100 Ω > 10 kΩ	9.900 k
10 kΩ > 1 kΩ	0.990 k
1 kΩ > 0.1 kΩ	0.099 k

When selecting the "AUTO" range, the items "MIN", "MAX", "P. TAR.A" will not be displayed in the "CHAN. A" setting

MODE	Selection of instrument measuring range	
	Menu	Measuring range
DC	80 mV	±60 mV
	160 mV	±160 mV
	300 mV	±300 mV
	1200mV	±12 V
DC - A	100 V	±100 V
	250 V	±250 V
	500 V	±500 V
	0.10 A	±0.1 A
	0.25 A	±0.25 A
	0.50 A	±0.5 A
1.00 A	±1 A	
5.00 A	±5 A	
PM	0.5mA	0..5 mA
	0.20mA	0..20 mA
	4.20mA	4..20 mA
	0.2 V	±2 V
	0.5 V	±5 V
	0.10 V	±10 V
	0.40 V	±40 V
	Er4:20	4..20 mA, with error statement of „underfl ow“ upon signal smaller than 3.36 mA
	100 R	0..100 Ω
	1 k	0..1 kΩ
10 k	0..10 kΩ	
100 k	0..100 kΩ	
AUTO	Autorange	
RTD-Pt	EU-100	Pt 100 (3 850 ppm/°C)
	EU-500	Pt 500 (3 850 ppm/°C)
	EU-1k0	Pt 1000 (3 850 ppm/°C)
	US-100	Pt 100 (3 920 ppm/°C)
	RU-50	Pt 50 (3 910 ppm/°C)
RU-100	Pt 100 (3 910 ppm/°C)	
RTD-Ni	5.0-1k	Ni 1 000 (5 000 ppm/°C)
	6.2-1k	Ni 1 000 (6 180 ppm/°C)
	5.0-10k	Ni 10 000 (5 000 ppm/°C)
	6.2-10k	Ni 10 000 (6 180 ppm/°C)
RTD-Cu	428-50	Cu 50 (4 280 ppm/°C)
	428-01	Cu 1 00 (4 280 ppm/°C)
	426-50	Cu 50 (4 260 ppm/°C)
	426-01	Cu 100 (4 260 ppm/°C)
T/C	T/C B	B
	T/C E	E
	T/C J	J
	T/C K	K
	T/C N	N
	T/C R	R
	T/C S	S
	T/C T	T
T/C L	L	



## 6.1.2d SELECTION OF TYPE OF SENSOR CONNECTION

RTD OHM T/C

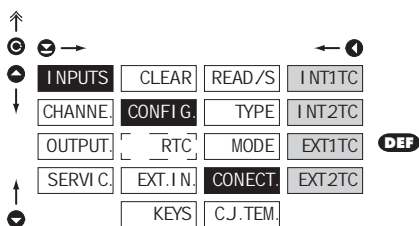
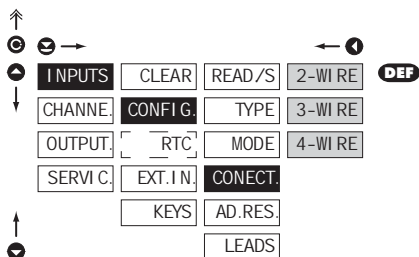
**CONECT.** Selection of type of sensor connection**RTD OHM**

- 2-WIRE 2-wire connection
- 3-WIRE 3-wire connection
- 4-WIRE 4-wire connection

**T/C**

- INT1TC Measurement without reference thermocouple
  - measuring cold junction at instrument brackets
- INT2TC Measurement with reference thermocouple
  - measuring cold junction at instrument brackets with anti-series connected reference thermocouple
- EXT1TC Measurement without reference thermocouple
  - the entire measuring set is working under invaried and constant temperature
- EXT2TC Measurement with reference thermocouple
  - when using compensation box

!

Method and procedure of setting the cold junctions is described in separate chapter on page 80

!

For thermocouple type 'B' the items **CONECT.** and **C.J. TEM.** are not available

## 6. SETTING PROFI

### 6.1.2e SETTING TEMPERATURE OF COLD JUNCTION

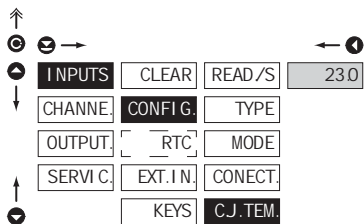
**T/C**

#### C.J. TEM. Setting temperature of cold junction

- range 0...99°C with compensation box

**DEF** = 23°C

### 6.1.2f ZERO OFFSET OF THE MEASUREMENT RANGE

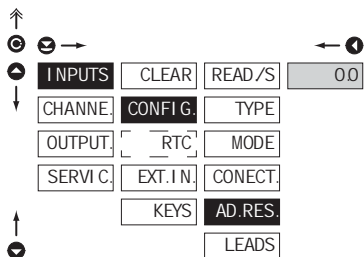
**RTD OHM**

#### AD.RES. Offset of the beginning of the measuring range

- in cases when it is necessary to offset the beginning of the range by certain value, e.g. while using sensor in measuring head

- entered directly in Dhmm [0...9999]

**DEF** = 0

### 6.1.2g COMPENSATION OF 2-WIRE CONDUCT

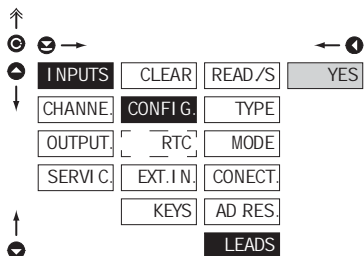
**RTD OHM**

#### LEADS Compensation of 2-wire conduct

- for measurement accuracy it is necessary to perform compensation of conduct always in case of 2-wire connection

- prior confirmation of the displayed prompt "YES" it is necessary to substitute the sensor at the end of the conduct by a short-circuit

**DEF** = 0

## 6.1.3 SETTING THE REAL TIME CLOCK

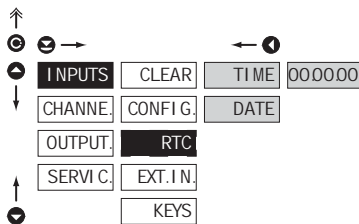

## RTC Setting the real time clock (RTC)

TIME Time setting

- format 23.59.59

DATE Date setting

- format DD.MM.YY

## 6.1.4a EXTERNAL INPUT FUNCTION SELECTION

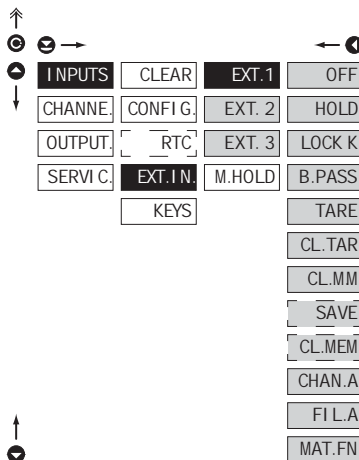

## EXT. I.N. External input function selection

OFF Input is off

HOLD Activation of HOLD

LOCK K. Locking keys on the instrument

B.PASS. Activation of locking access into programming menu

LIGHT/PROFI

TARE Tare activation

CL. TAR. Tare resetting

CL.MM. Resetting min/max value

SAVE Activation of measured data record in instrument memory

CL.MEM. Clearing memory for option FAST/RTC

CHAN.A Displaying value of "Channel A"

FI.LA Displaying value of "Channel A" after being processed by digital filters

MAT.FN. Displaying value of "Mathematical function"

- **DEF** EXT. 1 > HOLD- **DEF** EXT. 2 > LOCK K.- **DEF** EXT. 3 > TARE

\*

Procedure identical for EXT. 2 and EXT. 3

## 6. SETTING PROFI

### 6.1.4b SELECTION OF FUNCTION "HOLD"

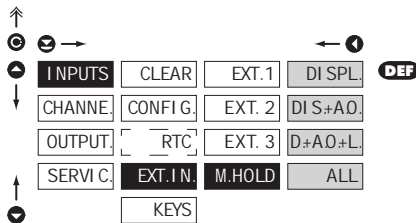

#### M.HOLD Selection of function "HOLD"

**DI SPL.** "HOLD" locks only the value displayed

**DI S+A.O.** "HOLD" locks the value displayed and on AD

**D+A.O.+L.** "HOLD" locks the value displayed, on AD and limit evaluation

**ALL** "HOLD" locks the entire instrument

### 6.1.5a OPTIONAL ACCESSORY FUNCTIONS OF THE KEYS

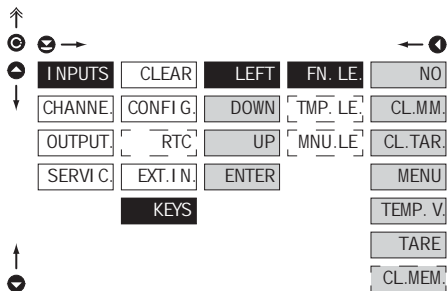

#### FN. LE. Assigning further functions to instrument keys

- „FN. LE.“ > executive functions

**NO** Key has no further function

**CL.MM.** Resetting min/max value

**CL.TAR.** Tare resetting

**MENU** Direct access into menu on selected item

- after confirmation of this selection the "MNU. LE." item is displayed on superior menu level, where required selection is performed

**TEMP. V.** Temporary projection of selected values

- after confirmation of this selection the item "TMP. LE." is displayed on superior menu level, where required selection is performed

**TARE** Tare function activation

**CL.MEM.** Clearing memory

- clearing memory with data measured in modes "FAST" or "RTC"

! Preset values of the control keys **DEF.**

LEFT Show Tare  
UP Show Max. value  
DOWN Show Min. value  
ENTER w/o functione

! Setting is identical for LEFT, DOWN, UP and ENTER

## 6.1.5b

## OPTIONAL ACCESSORY FUNCTIONS OF THE KEYS - TEMPORARY PROJECTION

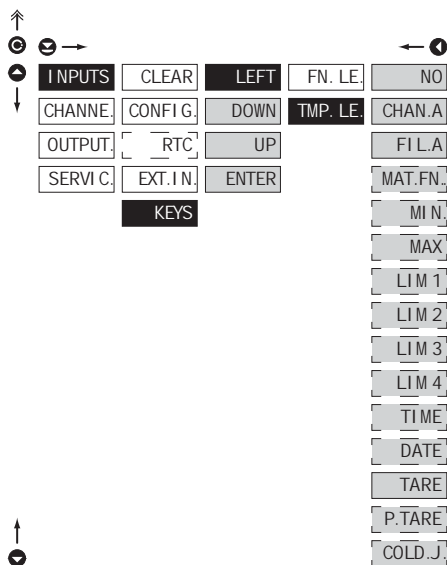
**TMP. LE.** Temporary projection of selected item

- „TMP. LE.“ > temporary projection of selected values
- "Temporary" projection of selected value is displayed for the time of keystroke
- "Temporary" projection may be switched to permanent by pressing **C** + "Selected key", this holds until the stroke of any key

NO	Temporary projection is off
CHAN.A	Temporary projection of "Channel A" value
FILA	Temporary projection of "Channel A" value after processing digital filters
MAT.FN.	Temporary projection of "Mathematic functions" value
MIN	Temporary projection of "Min. value"
MAX	Temporary projection of "Max. value"
LIM 1	Temporary projection of "Limit 1" value
LIM 2	Temporary projection of "Limit 2" value
LIM 3	Temporary projection of "Limit 3" value
LIM 4	Temporary projection of "Limit 4" value
TIME	Temporary projection of "TIME" value
DATE	Temporary projection of "DATE" value
TARE	Temporary projection of "TARE" value
P.TARE	Temporary projection of "P. TARE" value
COLD.J.	Temporary projection of "CJC" value

**!**  
Setting is identical for LEFT, DOWN, UP and ENTER

## 6. SETTING PROFI

6.1.5c

OPTIONAL ACCESSORY FUNCTIONS OF THE KEYS - DIRECT ACCESS TO ITEM

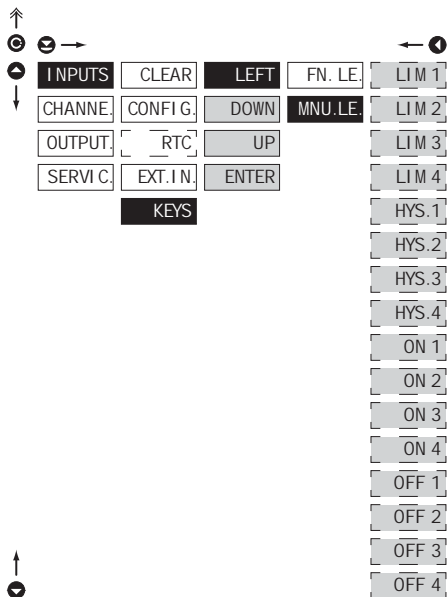

### MNU. LE. Assigning access to selected menu item

LIM 1	Direct access to item "LIM 1"
LIM 2	Direct access to item "LIM 2"
LIM 3	Direct access to item "LIM 3"
LIM 4	Direct access to item "LIM 4"
HYS. 1	Direct access to item "HYS. 1"
HYS. 2	Direct access to item "HYS. 2"
HYS. 3	Direct access to item "HYS. 3"
HYS. 4	Direct access to item "HYS. 4"
ON 1	Direct access to item "ON 1"
ON 2	Direct access to item "ON 2"
ON 3	Direct access to item "ON 3"
ON 4	Direct access to item "ON 4"
OFF 1	Direct access to item "OFF 1"
OFF 2	Direct access to item "OFF 2"
OFF 3	Direct access to item "OFF 3"
OFF 4	Direct access to item "OFF 4"

Setting is identical for LEFT, DOWN, UP and ENTER



## 6. SETTING PROFI

### 6.2 SETTING "PROFI" - CHANNELS

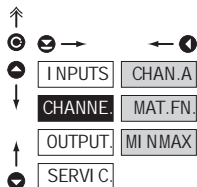

The primary instrument parameters are set in this menu

CHAN. A

Setting parameters of measuring "Channel A"

MAT. FN.

Setting parameters of mathematic functions

MI NMAX

Selection of access and evaluation of Min/max value

### 6.2.1a DISPLAY PROJECTION

DC PM DU OHM

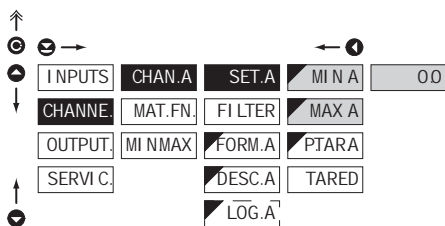

SET. A

Setting display projection

MI N A

Setting display projection for minimum value of input signal

- range of the setting: .99999...999999

- DEF = 0.0

MAX A

Setting display projection for maximum value of input signal

- range of the setting: .99999...999999

- DEF = 100.0

### 6.2.1b SETTING FIXED TARE

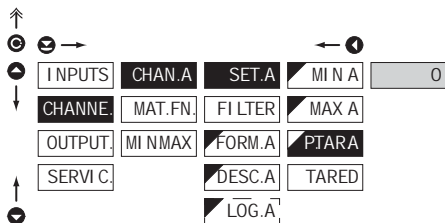

P. TAR. A

Setting "Fixed tare" value

- setting is designed for the event when it is necessary to firmly shift the beginning of the range by known size

- when setting [P. TAR. A≠ 0] is in effect, display does not show the "T" symbol

- range of the setting: .99999...999999

- DEF = 0

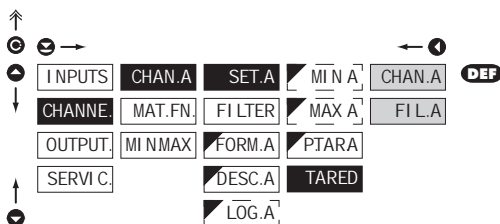

## 6.2.1c SELECTING WHERE TARE WILL BE APPLIED

**TARE** Selecting the position of tare

**CHAN.A** The value will be tared before linearisation and digital filter

**FI.LA** The value will be tared after linearisation and digital filter

## 6.2.1d DIGITAL FILTERS

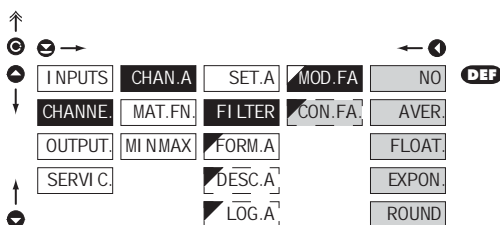
**MOD.FA** Selection of digital filters

- at times it is useful for better user projection of data on display to modify it mathematically and properly, wherefore the following filters may be used

**NO** Filters are off

**AVER.** Measured data average

- arithmetic average from given number (.CON.FA) of measured values

- range 2...100

**FLOAT.** Selection of floating filter

- floating arithmetic average from given number (.CON.FA) of measured data and updates with each measured value

- range 2...30

**EXPON.** Selection of exponential filter

- integration filter of first prvnho grade with time constant (.CON.FA) measurement

- range 2...100

**ROUND** Measured value rounding

- is entered by any number, which determines the projection step (e.g. .CON.FA = 2,5 > display 0, 2,5, 5,...)

**CON.FA** Setting constants

- this menu item is always displayed after selection of particular type of filter

- **DEF** = 2

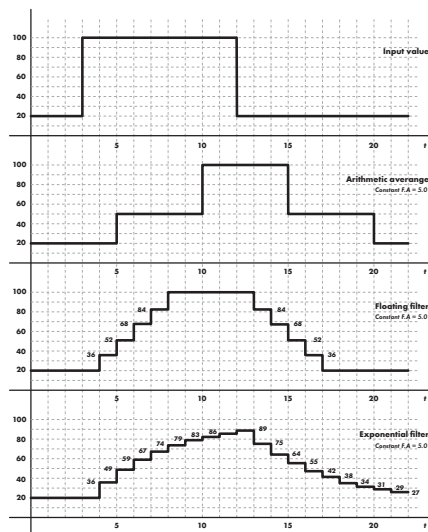

## 6. SETTING PROFI

### 6.2.1e PROJECTION FORMAT - POSITIONING OF DECIMAL POINT

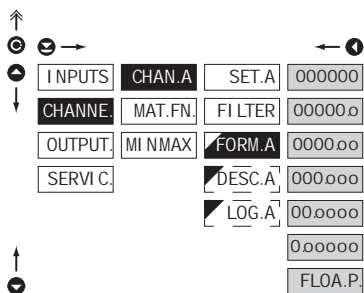

#### FORM.A Selection of decimal point

- the instrument allows for classic projection of a number with positioning of the DP as well as projection with floating DP, allowing to display a number in its most exact form „FLOAT.P.“

000000. Setting DP - XXXXXX.

00000o Setting DP - XXXXXx

DEF > RTD T/C

0000.oo Setting DP - XXXX.xx

DEF > DC PM DU OHM

000.ooo Setting DP - XXX.xxx

00.oooo Setting DP - XX.xxxx

0ooooo Setting DP - X.xxxxx

FLOA.P. Floating DP

### 6.2.1f PROJECTION OF DESCRIPTION - THE MEASURING UNITS

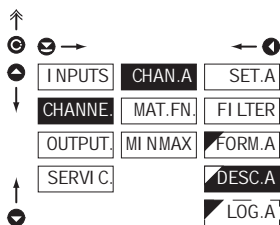

#### DESC.A Setting projection of descritp. for "Channel A"

- projection of measured data may be extended (at the expense of the number of displayed places) by two characters for description
- description is set by shifted ASCII code, when two first places show the set description and two last characters their code in period 0...95
- description is cancelled by code 00

RTD T/C DEF = °C

DC PM DU OHM DEF = none

! Table of signs on page 83



## 6. SETTING PROFI

6.2.2a

MATHEMATIC FUNCTIONS

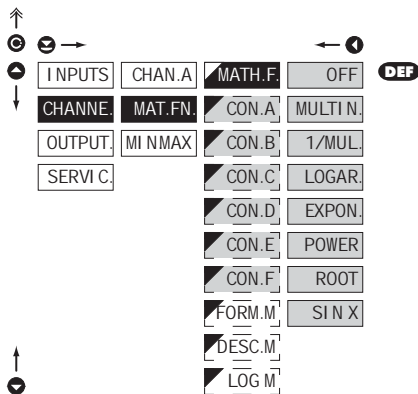

### MATH.F. Selection of mathematic functions

**OFF** Mathematic functions are off

**MULTI N.** Multinomial

$$Ax^5 + Bx^4 + Cx^3 + Dx^2 + Ex + F$$

**1/MUL.**  $1/x$

$$\frac{A}{x^5} + \frac{B}{x^4} + \frac{C}{x^3} + \frac{D}{x^2} + \frac{E}{x} + F$$

**LOGAR.** Logarithm

$$A \times \ln \left( \frac{Bx + C}{Dx + E} \right) + F$$

**EXPON.** Exponential

$$A \times e^{\left( \frac{Bx + C}{Dx + E} \right)} + F$$

**POWER** Power

$$A \times (Bx + C)^{(Dx + E)} + F$$

**ROOT** Root

$$A \times \sqrt{\frac{Bx + C}{Dx + E}} + F$$

**SIN X** Sin x

$$A \sin^5 x + B \sin^4 x + C \sin^3 x + D \sin^2 x + E \sin x + F$$

**CON.-** Setting constants for calculation of mat.functions

- this menu is displayed only after selection of given mathematic function



## 6. SETTING PROFI

### 6.2.2d MATHEMATIC FUNCTIONS - SELECTION OF STORING DATA INTO INSTRUMENT MEMORY

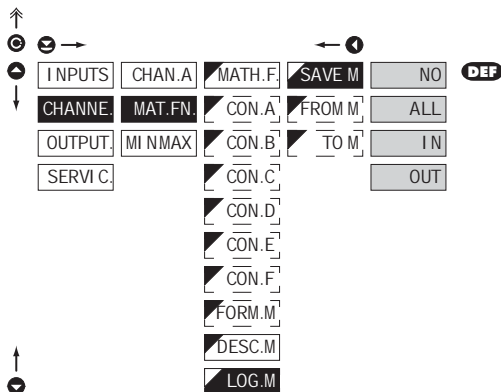

#### LOG.M Selection of storing data into instrument memory

- by selection in this item you allow to register values into instrument memory
- another setting in item "OUTPUT. > MEMORY" (not in standard experiment)

**NO** Measured data is not stored

**ALL** Measured data is stored in memory

**IN** Only data measured within the set interval is stored in memory

**OUT** Only data measured outside the set interval is stored in memory

**FROM M** Setting the initial interval value

- setting range: -99999...999999

**TO M** Setting the final interval value

- setting range: -99999...999999

### 6.2.3 SELECTION OF EVALUATION OF MIN/MAX VALUE

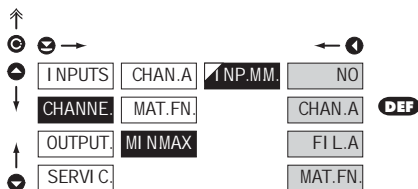

#### I NP.M.M. Selection of evaluation of min/max value

- selection of value from which the min/max value will be calculated

**NO** Evaluation of min/max value is off

**CHAN. A** From "Channel A"

**FI L.A** From "Channel A" after digital filters processing

**MAT. FN.** From "Mathematic functions"



## 6. SETTING PROFI

### 6.3 SETTING „PROFI“ - OUTPUTS

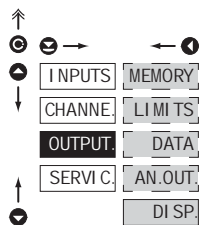

In this menu it is possible to set parameters of the instrument output signals

<b>MEMORY</b>	Setting data logging into memory
<b>LIMITS</b>	Setting type and parameters of limits
<b>DATA</b>	Setting type and parameters of data output
<b>AN. OUT.</b>	Setting type and parameters of analog output
<b>DI SP.</b>	Setting display projection and brightness

#### 6.3.1a SELECTION OF MODE OF DATA LOGGING INTO INSTRUMENT MEMORY

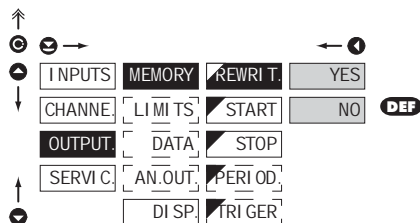

**REWRITE** Selection of the mode of data logging

- selection of the mode in the event of full instrument memory

<b>NO</b>	Rewriting values prohibited
<b>YES</b>	Rewriting values permitted, the oldest get rewritten by the latest



## 6.3.1b SETTING DATA LOGGING INTO INSTRUMENT MEMORY - RTC

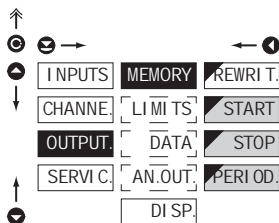

## RTC

The lowest recording rate possible is once a day, the highest is every second. Under exceptional circumstances it is possible to set the rate to 8 times per second by entering the recording period as 00:00:00. However, this mode is not recommended due to the memory overload. Recordings are realised in a timeframe of one day and are repeated periodically every following day. Recordings can take place either inside or outside of selected time intervals. The duration of re-writing can be determined by the number of channels recorded as well as by the recording rate.

**START** Start of data logging into instrument memory

- time format HH:MM:SS

**STOP** Stop data logging into instrument memory

- time format HH:MM:SS

**PERIOD** Period of data logging into instrument memory

- determines the period in which values will be logged in an interval delimited by the time set under items **START** and **STOP**
- time format HH:MM:SS
- records are made on a daily basis in selected interval and period
- item not displayed if "SAVE" is selected in menu (INPUT > EXT. IN.)

## 6.3.1c SETTING DATA LOGGING INTO INSTRUMENT MEMORY - FAST

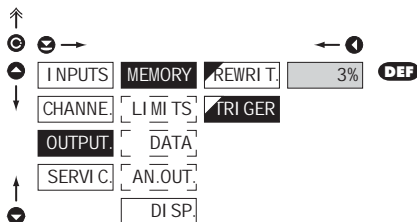
**TRIGGER** Setting logging data into inst. memory

- logging data into inst. memory is governed by the following selection, which determines how many percent of the memory is reserved for data logging prior to initiation of trigger impulse
- initialization is on ext. input or button
- setting in range 1...100 %
- when setting 100 %, datalogging works in the mode **ROLL** > data keep getting rewritten in cycles

**1. Memory initialization**

- clear memory (ext.input, button)
- LED "M" flashes, after reading **TRIGGER** [%] memory is permanently shining. In **ROLL** flashes constantly.

**2. Triggering**

- external input, button
- after the memory LED is full "M" turns off
- in the **ROLL** mode the trigger ends datalogging and LED turns off

**3. Termination**

- ext. input, button or reading data via RS

## FAST

The memory operates on the basis of memory oscilloscope. Select an area of 0...100% of the memory capacity. [100% represents 8 192 individual recordings for a single channel measurement]. This area is filled cyclically up to the point when the recording starts (activated by the front panel button or by an external input). When the remaining memory capacity fills up the recording stops. A new recording is possible after the deletion of the latest recording. It is possible to abort a recording before its completion by reading out the data.

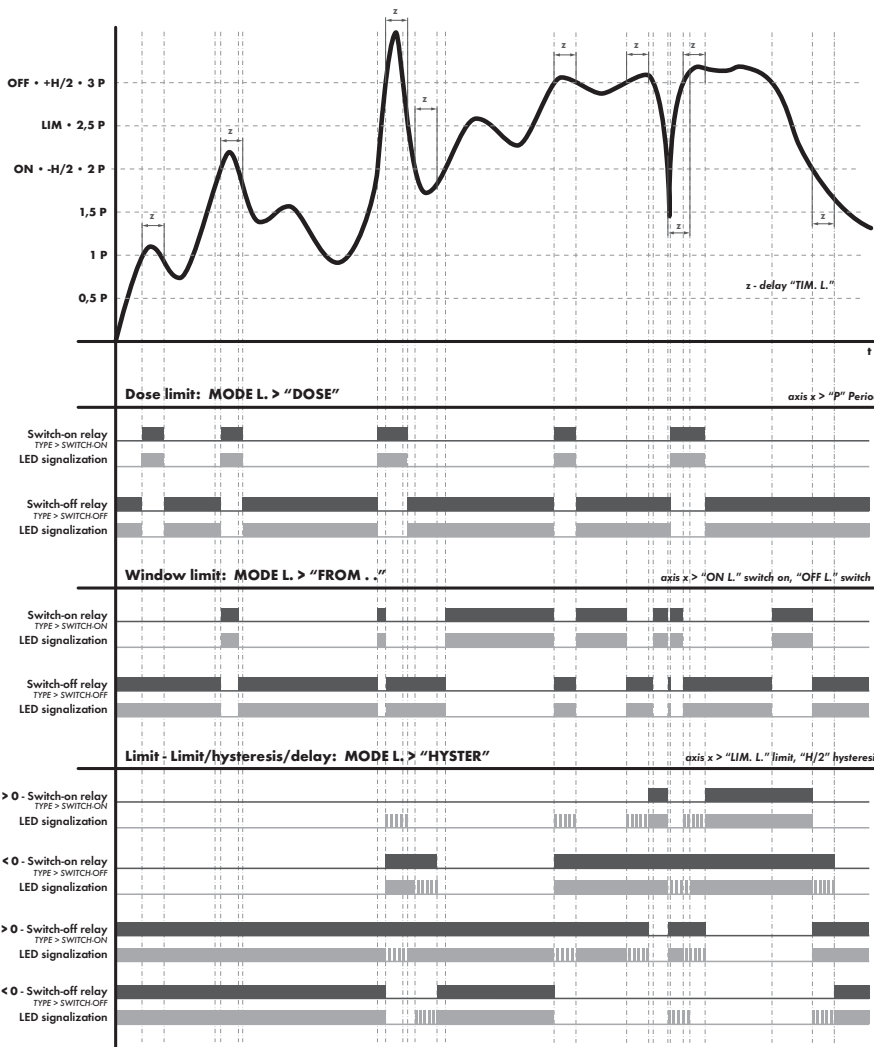

## 6.3.2a SELECTION OF INPUT FOR LIMITS EVALUATION

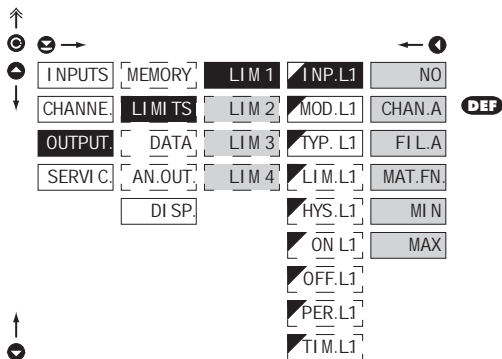
**INP.L1** Selection evaluation of limits

- selection of value from which the limit will be evaluated

NO	Limit evaluation is off
CHAN.A	Limit evaluation from "Channel A"
FIL.A	Limit evaluation from "Channel A" after digital filters processing
MAT.FN.	Limit evaluation from "Mathematic functions"
MIN	Limit evaluation from "Min. value"
MAX	Limit evaluation from "Max. value"

**!**  
Setting is identical for LIM 1, LIM 2, LIM 3 and LIM 4

## 6.3.2b SELECTION OF TYPE OF LIMIT

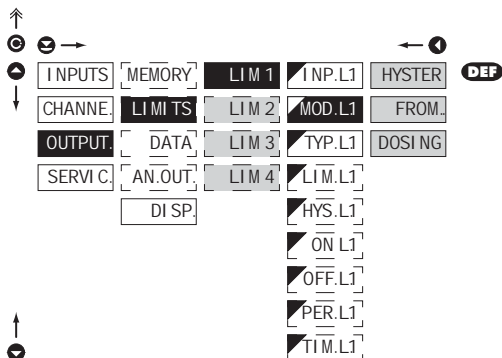
**MOD.L1** Selection the type of limit

- |        |   |
|--------|---|
| HYSTER | Limit is in mode "Limit, hysteresis, delay" |
|--------|---|
- for this mode the parameters of "LIM.L1" are set, at which the limit will shall react, "HYS.L1" the hysteresis range around the limit (LIM ±1/2 HYS) and time "TIM.L1" determining the delay of relay switch-on
- |       |             |
|-------|-------------|
| FROM. | Frame limit |
|-------|-------------|
- for this mode the parameters are set for interval "ON.L1" the relay switch-on and "OFF.L1" the relay switch-off
- |        |                       |
|--------|-----------------------|
| DOSING | Dose limit (periodic) |
|--------|-----------------------|
- for this mode the parameters are set for "PER.L1" determining the limit value as well as its multiples at which the output is active and "TIM.L2" indicating the time during which is the output active

**!**  
Setting is identical for LIM 1, LIM 2, LIM 3 and LIM 4

## 6. SETTING PROFI

### 6.3.2c SELECTION OF TYPE OF OUTPUT

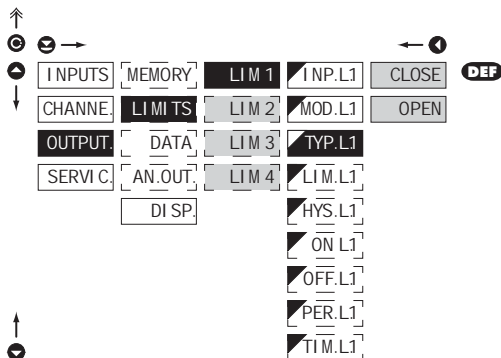

#### TYP.L1 Selection of type of output

**CLOSE** Output switches on when condition is met

**OPEN** Output switches off when condition is met

Setting is identical for LIM 1, LIM 2, LIM 3 and LIM 4

### 6.3.2d SETTING VALUES FOR LIMITS EVALUATION

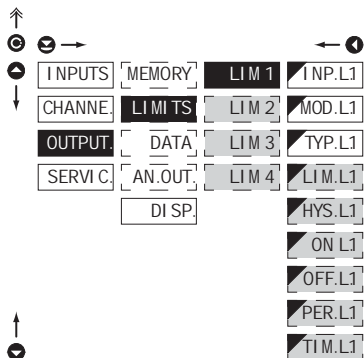

#### LIM.L1 Setting limit for switch-on

- for type "HYSTER"

#### HYS.L1 Setting hysteresis

- for type "HYSTER"  
- indicates the range around the limit (in both directions, LIM. ±1/2 HYS.)

#### ON.L1 Setting the outset of the interval of limit switch-on

- for type "FROM.."

#### OFF.L1 Setting the end of the interval of limit switch-on

- for type "FROM.."

#### PER.L1 Setting the period of limit switch-on

- for type "DOSING"

#### TIM.L1 Setting the time switch-on of the limit

- for type "HYSTER" and "DOSING"  
- setting within the range: ±0...99,9 s  
- positive time > relay switches on after crossing the limit (LIM. L1) and the set time (TIM. L1)  
- negative time > relay switches off after crossing the limit (LIM. L1) and the set negative time (TIM. L1)

Setting is identical for LIM 1, LIM 2, LIM 3 and LIM 4



## 6. SETTING PROFI

### 6.3.3c SELECTION OF DATA OUTPUT PROTOCOL

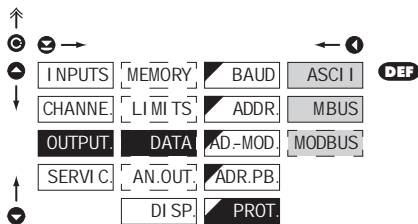

#### PROT. Selection of the type of analog output

**ASCII** Data protocol  
ASCII

**M.BUS** Data protocol  
DIN MessBus

**MODBUS** Data protocol  
MODBUS-RTU

- option is available only for RS 485

### 6.3.4a SELECTION OF INPUT FOR ANALOG OUTPUT

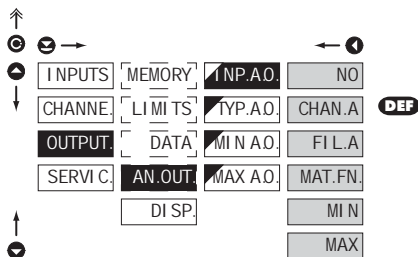

#### INP.A.O. Selection evaluation analog output

- selection of value from which the analog output will be evaluated

**NO** AD evaluation is off

**CHAN.A** AD evaluation from  
"Channel A"

**FI L.A** AD evaluation from  
"Channel A" after digital  
filters processing

**MAT.FN.** AD evaluation from  
"Math. functions"

**MI N** AD evaluation from  
"Min. value"

**MAX** AD evaluation from  
"Max. value"

## 6.3.4b SELECTION OF THE TYPE OF ANALOG OUTPUT

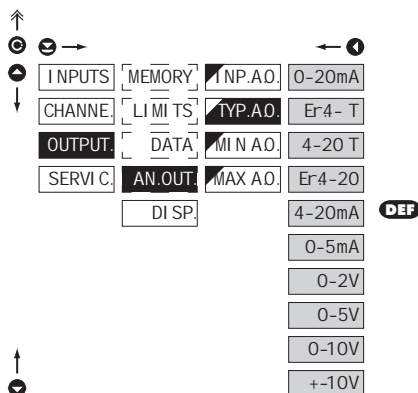

## TYP. A.O. Selection of the type of analog output

0-20mA Type - 0...20 mA

Er4- T Type: 4...20 mA with indication

- with broken loop detection and indication of error statement (&lt; 3.6 mA)

4-20 T Type: 4...20 mA with indication

- with broken loop detection (&lt; 3.6 mA)

Er4-20 Type: 4...20 mA with indication

- with indic. of error statement (&lt; 3.6 mA)

4-20mA Type - 4...20 mA

0-5mA Type - 0...5 mA

0-2V Type - 0...2 V

0-5V Type - 0...5 V

0-10V Type - 0...10 V

+10V Type - ±10 V

## 6.3.4c SETTING THE ANALOG OUTPUT RANGE

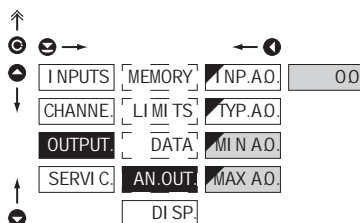

## AN. OUT. Setting the analog output range

- analog output is isolated and its value corresponds with displayed data. It is fully programmable, i.e. it allows to assign the AO limit points to two arbitrary points of the entire measuring range

**MI N A.O.** Assigning the display value to the beginning of the AO range

- range of the setting: -99999...999999

- **DEF** = 0

**MAX A.O.** Assigning the display value to the end of the AO range

- range of the setting: -99999...999999

- **DEF** = 100

## 6. SETTING PROFI

### 6.3.5a SELECTION OF INPUT FOR DISPLAY PROJECTION

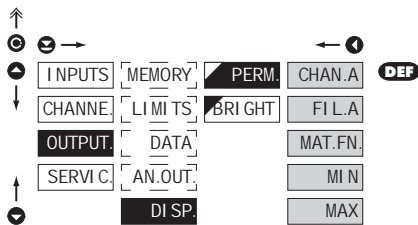

#### PERM. Selection display projection

- selection of value which will be shown on the instrument display

CHAN.A	Projection of values from "Channel A"
FI.L.A	Projection of values from "Channel A" after digital filters processing
MAT.FN.	Projection of values from "Math. functions"
MI.N	Projection of values from "Min. value"
M.A.X	Projection of values from "Max. value"

### 6.3.5b SELECTION OF DISPLAY BRIGHTNESS

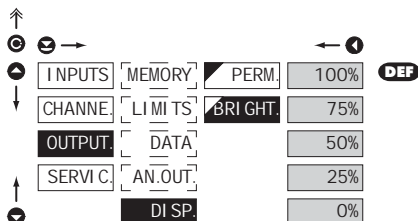

#### BRI.GHT. Selection of display brightness

- by selecting display brightness we may appropriately react to light conditions in place of instrument location

0%	Display is off
25%	Display brightness - 25%
50%	Display brightness - 50%
75%	Display brightness - 75%
100%	Display brightness - 100%





## 6. SETTING PROFI

### 6.4 SETTING "PROFI" - SERVICE

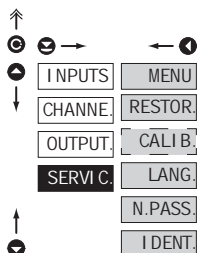

The instrument service functions are set in this menu

<b>MENU</b>	Selection of menu type LIGHT/PROFI
<b>RESTOR.</b>	Restore instrument manufacture setting and calibration
<b>CALI B.</b>	Input range calibration for „DU“ version
<b>LANG.</b>	Language version of instrument menu
<b>N.PASS.</b>	Setting new access password
<b>I DENT.</b>	Instrument identification

#### 6.4.1 SELECTION OF TYPE OF PROGRAMMING MENU

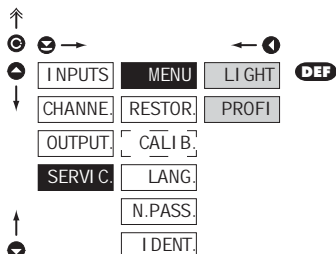

#### **MENU** Selection of menu type - LIGHT/PROFI

- enables setting the menu complexity according to user needs and skills

#### **LI GHT** Active LIGHT menu

- simple programming menu, contains only items necessary for configuration and instrument setting  
- linear menu > items one after another

#### **PROFI** Active PROFI menu

- complete programming menu for expert users  
- tree menu



Change of setting is valid upon next access into menu

## 6.4.2 RESTORATION OF MANUFACTURE SETTING

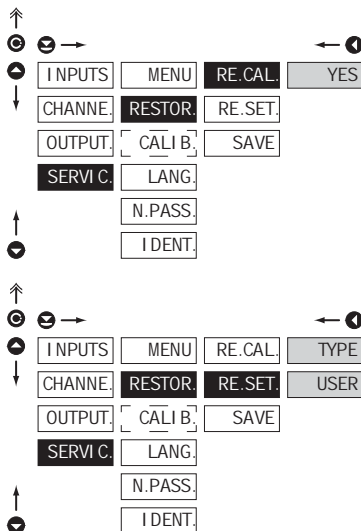
**RESTOR.** Restoration of manufacture setting

- in the event of error setting or calibration, manufacture setting may be restored

**RE.CAL.** Restoration of manufacture calibration of the instrument

- prior executing the changes you will be asked to confirm you selection 'YES'

**RE.SET.** Restoration of instrument manufacture setting**TYPE** Restoration of instrument manufacture setting

- generating the manufacture setting for currently selected type of instrument (items marked DEF)

**USER** Restoration of instrument user setting

- generating the instrument user setting, i.e. setting stored under **SERVI./RESTOR./SAVE**

**SAVE** Save instrument user setting

- storing the user setting allows the operator to restore it in future if needed



After restoration the instrument switches off for couple seconds

**JOBS PERFORMED****RESTORE**

JOBS PERFORMED	RESTORE	
	CALIBRATION	SETTING
cancel USER menu rights	✓	✓
deletes table of items order in USER - LIGHT menu	✓	✓
adds items from manufacture to LIGHT menu	✓	✓
deletes data stored in FLASH	✓	✓
cancel or linearization tables	✓	✓
clears tare	✓	✓
restore manufacture calibration	✓	✗
restore manufacture setting	✗	✓

## 6. SETTING PROFI

### 6.4.3 CALIBRATION - INPUT RANGE

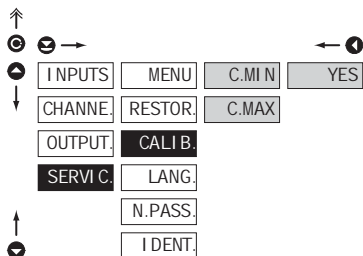
**DU**

#### CALI B. Input range calibration

- when "C. MIN" is displayed, move the potentiometer traveller to the required minimum position and confirm by „Enter“, calibration is confirmed by "YES"
- when "C. MAX" is displayed, move the potentiometer traveller to required maximum position and confirm by „Enter“, calibration is confirmed by "YES"

### 6.4.4 SELECTION OF INSTRUMENT MENU LANGUAGE VERSION

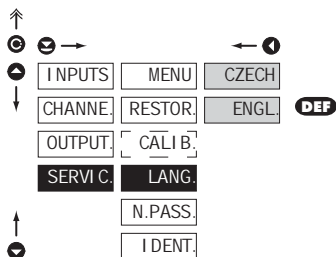

#### LANG. Selection of instrument menu language version

- CZECH** Instrument menu is in Czech
- ENGL.** Instrument menu is in English

### 6.4.5 SETTING NEW ACCESS PASSWORD

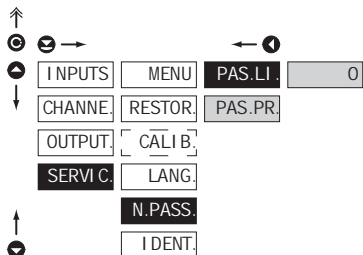

#### N. PASS. Setting new password for access to LIGHT and PROFi menu

- this option allows to change the numeric code, which blocks the access into LIGHT and PROFi menu.
- numerical code range: 0...9999
- universal passwords in the event of loss:  
LIGHT Menu > „8177“  
PROFI Menu > „7915“

## 6.4.6 INSTRUMENT IDENTIFICATION

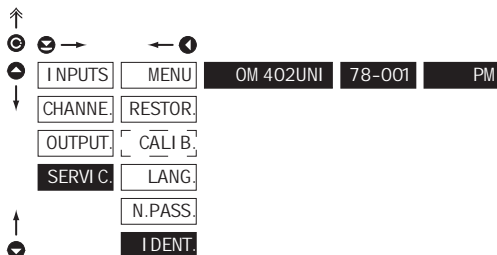
**I.DENT.** Projection of instrument SW version

- display shows type identification of the instrument, SW number, SW version and current input setting (Mode)
- if the SW version reads a letter on first position, it is a customer SW

	Pos.	Description
<b>I.DENT.</b>	1.	type of instrument
	2.	SW. number - version
	3.	the input type



# SETTING USER

For user operation

Menu items are set by the user (Profi/Light) as per request

Access is not password protected

Optional menu structure either tree (PROFI) or linear (LIGHT)

## 7.0 SETTING ITEMS INTO "USER" MENU

- **USER** menu is designed for users who need to change only several items of the setting without the option to change the primary instrument setting (e.g. repeated change of limit setting)
- there are no items from manufacture permitted in **USER** menu
- on items indicated by inverse triangle  LIM 1
- setting may be performed in **LIGHT** or **PROFI** menu, with the **USER** menu then overtaking the given menu structure

### Setting

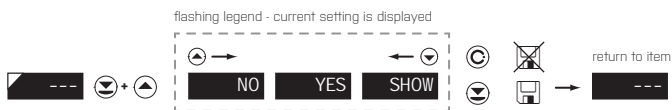

**NO**

item will not be displayed in USER menu

**YES**

item will be displayed in USER menu with editing option

**SHOW**

item will be solely displayed in USER menu

## Setting sequence of items in "USER" menu

In compiling USER menu from active LIGHT menu the items (max. 10) may be assigned a sequence, in which they will be projected in the menu

setting projection sequence



## Example of ranking the order of menu items in the "USER" menu

In this example we want to have a direct access to menu items Limit 1 and Limit 2 (example show is for the Light menu, but can equally be used in the Profi menu).

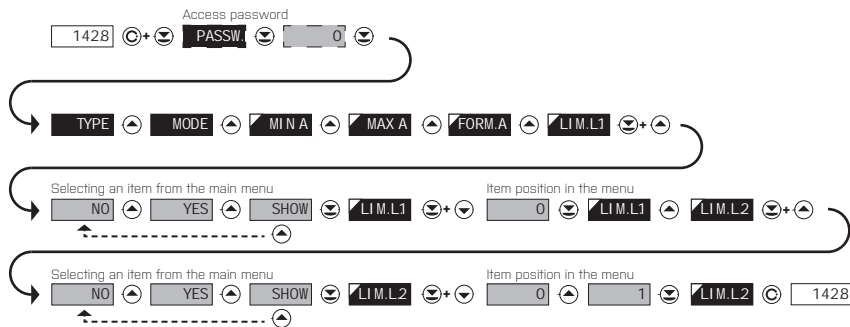

The result of this setting is that when the **Ⓢ** button is pressed, the display will read „LIM L.1“. By pressing **Ⓢ** button you confirm your selection and then you can set the desired limit value, or by pressing the **Ⓢ** button you can go to setting of „LIM. L.2“ where you can proceed identically as with Limit one.

You can exit the setting by pressing the **Ⓢ** button by which you store the latest setting and pressing the **Ⓢ** button will take you back to the measuring mode

## 8. METHOD OF MEASURING THE CJC

Instrument with input for temperature measurement with thermocouple allows to set two types of measurement of cold junction.

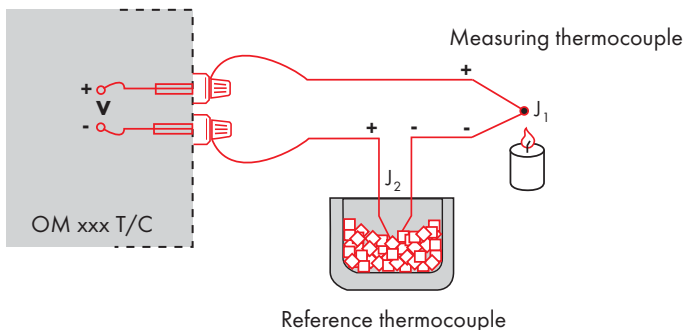

### WITH REFERENCE THERMOCOUPLE

- a reference thermocouple may be located in the same place as the measuring instrument or in place with stable temperature/compensation box
- when measuring with reference thermocouple set **CONNECT** in the instrument menu to **I NT2TC** or **EXT2TC**
- when using a thermostat (a compensation box or environment with constant temperature) set in the instrument menu **CJCTEM**, its temperature (applies for setting **CONNECT** to **EXT2TC**)
- if the reference thermocouple is located in the same environment as the measuring instrument then set in the instrument menu **CONNECT** to **I NT2TC**. Based on this selection the measurement of the ambient temperature is performed by a sensor located in the instrument terminal board

### WITHOUT REFERENCE THERMOCOUPLE

- inaccuracy originating from the creation of dissimilar thermocouples on the transition point terminal/conductor of the thermocouple is not compensated for in the instrument
- when measuring without reference thermocouple set **CONNECT** in the instrument menu to **I NT1TC** or **EXT1TC**
- when measuring temperature without reference thermocouple the error in measured data may be as much as 10°C (applies for setting **CONNECT** to **EXT1TC**)



The instruments communicate via serial line RS232 or RS485. For communication they use the ASCII protocol. Communication runs in the following format - ASCII (8 bit, no parity, one stop bit), DIN MessBus (7 bit, even parity, one stop bit).

The transfer rate is adjustable in the instrument menu. The instrument address is set in the instrument menu in the range of 0 - 31. The manufacture setting always presets the ASCII protocol, rate of 9600 Baud, address 00. The type of line used - RS232 / RS485 - is determined by an output board automatically identified by the instrument.

The commands are described in specifications you can find at [www.orbit.merret.cz](http://www.orbit.merret.cz) or SW OM Link

## DETAILED DESCRIPTION OF COMMUNICATION VIA SERIAL LINE

EVENT	TYPE	PROTOCOL	TRANSMITTED DATA												
Data solicitation (PC)	232	ASCII	#	A	A	<CR>									
		MessBus	No - data is transmitted permanently												
	485	ASCII	#	A	A	<CR>									
		MessBus	<SADR> <ENQ>												
Data transmission (instrument)	232	ASCII	>	0	[0]	[0]	[0]	[0]	[0]	[0]	[0]	[0]	[0]	[0]	<CR>
		MessBus	<STX>	0	[0]	[0]	[0]	[0]	[0]	[0]	[0]	[0]	[0]	[0]	[0]
	485	ASCII	>	0	[0]	[0]	[0]	[0]	[0]	[0]	[0]	[0]	[0]	[0]	<CR>
		MessBus	<STX>	0	[0]	[0]	[0]	[0]	[0]	[0]	[0]	[0]	[0]	[0]	<ETX> <BCC>
Instrument identification			#	A	A	1	Y	<CR>							
HW identification			#	A	A	1	Z	<CR>							
One-time transmission			#	A	A	7	X	<CR>							
Repeated transmission			#	A	A	8	X	<CR>							

## LEGEND

SIGN	RANGE	DESCRIPTION
#	35 23 <sub>H</sub>	Command beginning
A	A 0...31	Two characters of instrument address (sent in ASCII - tens and units, e.g. '01', '99' universal)
<CR>	13 00 <sub>H</sub>	Carriage return
<SP>	32 20 <sub>H</sub>	Space
N, P		Number and command - command code
0		Data - usually characters '0'...'9', '*', ':', '(', ') - dp. and ( ) may prolong data
R	30 <sub>H</sub> ...3F <sub>H</sub>	Relay and tare status
!	33 21 <sub>H</sub>	Positive confirmation of command (ok)
?	63 3F <sub>H</sub>	Negative confirmation of command (point)
>	62 3E <sub>H</sub>	Beginning of transmitted data
<STX>	2 02 <sub>H</sub>	Beginning of text
<ETX>	3 03 <sub>H</sub>	End of text
<SADR>	adresa +60 <sub>H</sub>	Prompt to send from address
<EADR>	adresa +40 <sub>H</sub>	Prompt to accept command at address
<ENQ>	5 05 <sub>H</sub>	Terminate address
<DLE>	>1 16 49 10, 31 <sub>H</sub>	Confirm correct statement
<NAK>	21 15 <sub>H</sub>	Confirm error statement
<BCC>		Check sum -XDR

## RELAY, TARE

SIGN	RELAY 1	RELAY 2	TARE	CHANGE RELAY 3/4
P	0	0	0	0
Q	1	0	0	0
R	0	1	0	0
S	1	1	0	0
T	0	0	1	0
U	1	0	1	0
V	0	1	1	0
W	1	1	1	0
p	0	0	0	1
q	1	0	0	1
r	0	1	0	1
s	1	1	0	1
t	0	0	1	1
u	1	0	1	1
v	0	1	1	1
w	1	1	1	1

Relay status is generated by command #AAGX <CR>.

The instrument immediately returns the value in the format >HH <CR>, where HH is value in HEX format and range 00<sub>H</sub>...FF<sub>H</sub>. The lowest bit stands for „Relay 1“, the highest for „Relay 8“

## 10. ERROR STATEMENTS



ERROR	CAUSE	ELIMINATION
E.d.Un.	Number is too small (large negative) to be displayed	change DP setting, channel constant setting
E.d.Ow.	Number is too large to be displayed	change DP setting, channel constant setting
E.t.Un.	Number is outside the table range	increase table values, change input setting (channel constant setting)
E.t.Ow.	Number is outside the table range	increase table values, change input setting (channel constant setting)
E.I.Un.	Input quantity is smaller than permitted input quantity range	change input signal value or input (range) setting
E.I.Ow.	Input quantity is larger than permitted input quantity range	change input signal value or input (range) setting
E.Hw.	A part of the instrument does not work properly	send the instrument for repair
E.EE	Data in EEPROM corrupted	perform restoration of manufacture setting, upon repeated error statement send instrument for repair
E.SET.	Data in EEPROM outside the range	perform restoration of manufacture setting, upon repeated error statement send instrument for repair
E.CLR	Memory was empty (presetting carried out)	upon repeated error statement send instrument for repair, possible failure in calibration
E.OUT.	Analogue output current loop disconnected	check wire connection



The instrument allows to add two descriptive characters to the classic numeric formats (at the expense of the number of displayed places). The setting is performed by means of a shifted ASCII code. Upon modification the first two places display the entered characters and the last two places the code of the relevant symbol from 0 to 95. Numeric value of given character equals the sum of the numbers on both axes of the table.

Description is cancelled by entering characters with code 00

	0	1	2	3	4	5	6	7		0	1	2	3	4	5	6	7
0		Q	"	&	\$	%	&	'	0	!	"	#	\$	%	&	'	
8	:	:	#	+	,	-	.	/	8	(	)	*	+	,	-	.	/
16	0	1	2	3	4	5	6	7	16	0	1	2	3	4	5	6	7
24	8	9	VA	Vr	<	=	>	?	24	8	9	VA	Vr	<	=	>	?
32	P	R	B	C	D	E	F	G	32	@	A	B	C	D	E	F	G
40	H	I	J	K	L	M	N	O	40	H	I	J	K	L	M	N	O
48	P	Q	R	S	T	U	V	W	48	P	Q	R	S	T	U	V	W
56	X	Y	Z	[	\	]	^	_	56	X	Y	Z	[	\	]	^	_
64	`	a	b	c	d	e	f	g	64	`	a	b	c	d	e	f	g
72	h	i	j	k	l	m	n	o	72	h	i	j	k	l	m	n	o
80	p	q	r	s	t	u	v	w	80	p	q	r	s	t	u	v	w
88	x	y	z	{		}	~		88	x	y	z	{		}	~	

## 12. TECHNICAL DATA

### INPUT

range is adjustable

±60 mV	>100 MΩ	Input U
±150 mV	>100 MΩ	Input U
±300 mV	>100 MΩ	Input U
±1200 mV	>100 MΩ	Input U

range is adjustable

±0,1 A	< 300 mV	Input I
±0,25 A	< 300 mV	Input I
±0,5 A	< 300 mV	Input I
±1 A	< 30 mV	Input I
±5 A	< 150 mV	Input I
±100 V	20 MΩ	Input U
±250 V	20 MΩ	Input U
±500 V	20 MΩ	Input U

range is adjustable

0/4...20 mA	< 400 mV	Input I
±2 V	1 MΩ	Input U
±5 V	1 MΩ	Input U
±10 V	1 MΩ	Input U
±40 V	1 MΩ	Input U

range is adjustable

0...100 Ω		Input I
0...1 kΩ		Input I
0...10 kΩ		Input I
0...100 kΩ		Input I
Autorange		Input I

Connection: 2, 3 or 4 wire

Pt xxxx	-200°...850°C	RTD
Pt xxxx/3910 ppm	-200°...1100°C	
Ni xxxx	-50°...250°C	
Cu/4260 ppm	-50°...200°C	
Cu/4280 ppm	-200°...200°C	

Type Pt: EU > 100/500/1 000 Ω, with 3 850 ppm/°C  
 US > 100 Ω, with 3 920 ppm/°C  
 RU > 50/100 Ω, with 3 910 ppm/°C

Type Ni: Ni 1 000/ Ni 10 000 with 5 000/6 180 ppm/°C  
 Type Cu: Cu 50/Cu 100 with 4 260/4 280 ppm/°C  
 Connection: 2, 3 or 4 wire

range is adjustable in configuration menu

Type:	J (Fe-CuNi)	-200°...900°C	T/C
	K (NiCr-Ni)	-200°...1 300°C	
	T (Cu-CuNi)	-200°...400°C	
	E (NiCr-CuNi)	-200°...690°C	
	B (PtRh30-PtRh6)	300°...1 820°C	
	S (PtRh10-Pt)	-50°...1 760°C	
	R (Pt13Rh-Pt)	-50°...1 740°C	
	N (Omega alloy)	-200°...1 300°C	
	L (Fe-CuNi)	-200°...900°C	

Voltage of lin. pot. 2,5 VDC/6 mA  
 min. potentiometer resistance is 500 Ω

### PROJECTION

Display:	999999, intensive red or green 14 segment LED, digit height 14mm
Projection:	±9999 (999999...999999)
Decimal point:	adjustable - in menu
Brightness:	adjustable - in menu

### INSTRUMENT ACCURACY

TC:	50 ppm/°C
Accuracy:	±0,1% of range + 1 digit
	±0,15% of range + 1 digit
	<b>Above accuracies apply for projection 9999</b>

Resolution:	0,01%/0,1%/*	RTD
Rate:	0,1...40 measurements/s**	
Overload capacity:	10x (t < 100 ms) not for 500 V and 5 A, 2x (long-term)	

Linearisation:	by linear interpolation in 38 points - solely via DM Link	
Digital filters:	Averaging, Floating average, Exponential filter, Rounding	
Comp. of conduct:	max. 40 Ω/100 Ω	RTD
Comp. of cold junc.:	adjustable	T/C

Functions:	0°...99°C or automatic Tare - display resetting Hold - stop measuring (at contact) Lock - control key locking MM - min/max value Mathematic functions
------------	--

DM Link:	company communication interface for setting, operation and update of instrument SW
Watch-dog:	reset after 400 ms
Calibration:	at 25°C and 40% of r.h.

### COMPARATOR

Type:	digital, adjustable in menu
Mode:	Hysteresis, From, Dosing
Limits:	-999999...999999
Hysteresis:	0...999999
Delay:	0...99,9 s
Outputs:	2x relays with switch-on contact (Form A) (230 VAC/30 VDC, 3 A)* 2x relays with switch-off contact (Form C) (230 VAC/50 VDC, 3 A)* 2x SSR (250 VAC/1 A)* 2x/4x open collector (30 VDC/100 mA) 2x bistabil relays (250 VAC/250 VDC, 3 A/0,3 A)* 1/8 HP 277 VAC, 1/10 HP 125 V, Pilot Duty D300
Relay:	

\* values apply for resistance load

**DATA OUTPUTS**

Protocols:	ASCII, DIN MessBus, MODBUS, PROBUS
Data format:	8 bit + no parity + 1 stop bit (ASCII) 7 bit + even parity + 1 stop bit (MessBus)
Rate:	600...230 400 Baud 9 600 Baud...12 Mbaud (PROFIBUS)
RS 232:	isolated, two-way communication
RS 485:	isolated, two-way communication, addressing (max. 31 instruments)
PROFIBUS	Data protocol SIEMENS

**ANALOG OUTPUTS**

Type:	isolated, programmable with 16 bits Q/A converter, analogoutput corresponds with displayed data, type and range are adjustable
Non-linearity:	0,1% of range
TC:	15 ppm/°C
Rate:	response to change of value < 1 ms
Voltage:	0...2 V/5 V/10 V/±10 V
Current:	0...5/20 mA/4...20 mA - compensation of conduct to 500 Ω/12 V or 1 000 Ω/24 V

**MEASURED DATA RECORD**

Type RTC:	time-controlled logging of measured data into instrument memory, allows to log up to 250 000 values
Type FAST:	fast data logging into instrument memory, allows to log up to 8 000 values at a rate of 40 records/s
Transmission:	via data output RS 232/485 or via QM Link

**EXCITATION**

Adjustbale:	5...24 VDC/max. 1,2 W, isolated
-------------	---------------------------------

**POWER SUPPLY**

Options:	10...30 V AC/DC, max. 13,5 VA, PF ≥ 0,4, $I_{LTP} < 40 \text{ A/1 ms}$ , isolated - fuse inside (T 4000 mA)
	80...250 V AC/DC, max. 13,5 VA, PF ≥ 0,4, $I_{LTP} < 40 \text{ A/1 ms}$ , isolated - fuse inside (T 630 mA)

**MECHANIC PROPERTIES**

Material:	Noryl GFN2 SE1, incombustible UL 94 V-I
Dimensions:	96 x 48 x 120 mm
Panel cut-out:	90,5 x 45 mm

**OPERATING CONDITIONS**

Connection:	connector terminal board, conductor cross-section <1,5 mm <sup>2</sup> / <2,5 mm <sup>2</sup>
Stabilisation period:	within 15 minutes after switch-on
Working temp.:	-20°...60°C
Storage temp.:	-20°...85°C
Cover:	IP64 (front panel only)
Construction:	safety class I
Dielectric strength:	4 kVAC after 1 min between supply and input 4 kVAC after 1 min between supply and data/ analog output 4 kVAC after 1 min between supply and relay output 2,5 kVAC after 1 min between supply and data/ analog output
Overvoltage cat.:	EN 61010-1, A2
Insulation resist.:	for pollution degree II, measurement cat. III instrum.power supply > 670 V (PI), 300 V (DI) Input/output > 300 V (PI), 150 (DI)
EMC:	EN 61326-1
Seismic resistance:	IEC 980: 1993, par. 6

\*\*Table of rate of measurement in relation to number of inputs

Channels/Rate	40	20	10	5	2	1	0,5	0,2	0,1
No.of channels: 1 [Type: DC, PM, DU]	40,00	20,00	10,00	5,00	2,00	1,00	0,50	0,20	0,10
No.of channels: 2	5,00	2,50	1,25	1,00	0,62	0,38	0,22	0,09	0,05
No.of channels: 3	3,33	1,66	0,83	0,66	0,42	0,26	0,14	0,06	0,03
No.of channels: 4	2,50	1,25	0,62	0,50	0,31	0,19	0,11	0,05	0,02
No.of channels: 1 [Type: OHM, RTD, T/C]	5,00	2,50	1,25	1,00	0,62	0,38	0,22	0,09	0,05
No.of channels: 2	3,33	1,66	0,83	0,66	0,42	0,26	0,14	0,06	0,03
No.of channels: 3	2,50	1,25	0,62	0,50	0,31	0,19	0,11	0,05	0,02
No.of channels: 4	2,00	1,00	0,50	0,40	0,25	0,15	0,08	0,04	0,02

## 13. INSTRUMENT DIMENSIONS AND INSTALLATION



**Front view**



**Panel cut**

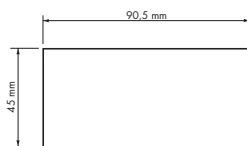

**Side view**

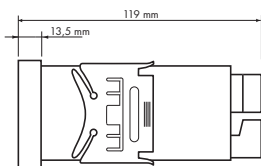

Panel thickness: 0,5...20 mm

### INSTRUMENT INSTALLATION

1. insert the instrument into the panel cut-out
2. fit both travellers on the box
3. press the travellers close to the panel

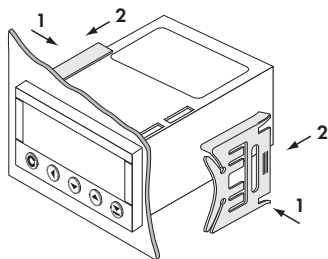
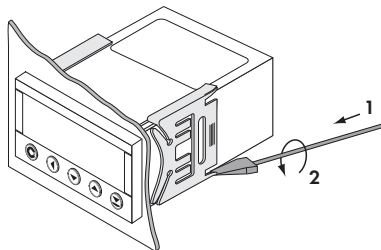

### INSTRUMENT DISASSEMBLY

1. slide a screw driver under the traveller wing
2. turn the screw driver and remove the traveller
3. take the instrument out of the panel



Product **DM 402UNI**  
Type .....  
Manufacturing No. ....  
Date of sale .....

**A**

# GUARANTEE

A guarantee period of 60 months from the date of sale to the user applies to this instrument.  
Defects occurring during this period due to manufacture error or due to material faults shall be eliminated free of charge.

For quality, function and construction of the instrument the guarantee shall apply provided that the instrument was connected and used in compliance with the instructions for use.

The guarantee shall not apply to defects caused by:

- mechanic damage
- transportation
- intervention of unqualified person incl. the user
- unavoidable event
- other unprofessional interventions

The manufacturer performs guarantee and post.guarantee repairs unless provided for otherwise.

Y E A R S

Stamp, signature



**Company:** **ORBIT MERRET, spol. s r.o.**  
Klánova 81/141, 142 00 Prague 4, Czech Republic, IDNo.: 00551309

**Manufactured:** **ORBIT MERRET, spol. s r.o.**  
Vodňanská 675/30, 198 00 Prague 9, Czech Republic

declares at its explicit responsibility that the product presented hereunder meets all technical requirements, is safe for use when utilised under the terms and conditions determined by ORBIT MERRET, spol.s r.o. and that our company has taken all measures to ensure conformity of all products of the types referred-to hereunder, which are being brought out to the market, with technical documentation and requirements of the appurtenant Czech statutory orders.

**Product:** Programmable panel instrument

**Type** **DM 402**

**Version:** UNI, PWR

#### **This has been designed and manufactured in line with requirements of:**

Statutory order no. 17/2003 Coll., on low-voltage electrical equipment (directive no. 73/23/EHS)  
Statutory order no. 616/2006 Coll., on electromagnetic compatibility (directive no. 2004/108/EHS)

#### **The product qualities are in conformity with harmonized standard:**

El. safety: EN 61010-1

EMC: EN 61326-1

Electronic measuring, control and laboratory devices – Requirements for EMC "Industrial use"  
EN 50131-1, chap. 14 and chap. 15, EN 50130-4, chap. 7, EN 50130-4, chap. 8, [EN 61000-4-11, ed. 2],  
EN 50130-4, chap. 9 [EN 61000-4-2], EN 50130-4, chap. 10, [EN 61000-4-3, ed. 2], EN 50130-4, chap. 11 [EN 61000-4-6],  
EN 50130-4, chap. 12, [EN 61000-4-4, ed. 2], EN 50130-4, chap. 13 [EN 61000-4-5], EN 61000-4-8, EN 61000-4-9,  
EN 61000-6-1, EN 61000-6-2, EN 65022, chap. 5 and chap. 6

Seismic resistance: IEC 980: 1993, par. 6

The product is furnished with CE label issued in 2006

#### **As documentation serve the protocols of authorized and accredited organizations:**

EMC: MD CR, Testing institute of technical devices, protocol no. 80/6-46/2006 of 03/03/2006  
MD CR, Testing institute of technical devices, protocol no. EMI.80/6-333/2006 of 15/01/2007  
Seismic resistance: VOP-026 Stemberk, protocol no.: 6430-16/2007 of 07/02/2007

Place and date of issue: Prague, 19. Juli 2010

Miroslav Hackl  
Company representative

Assessment of conformity pursuant to §22 of Act no. 22/1997 Coll. and changes as amended by Act no.71/2000 Coll. and 205/2002 Coll