



OM 402UNI - B

4 DIGIT PROGRAMMABLE UNIVERSAL 4-CHANNEL INSTRUMENT

DC VOLTMETER /AMMETER
PROCESS MONITOR
OHMMETER
THERMOMETER FOR PT 100/500/1 000
THERMOMETER FOR NI 1 000
THERMOMETER FOR THERMOCOUPLES
DISPLAYS FOR LIN. POTENTIOMETERS



SAFETY INSTRUCTIONS

Please, read the enclosed safety instructions carefully and observe them!
These instruments should be safeguarded by isolated or common fuses (breakers)!
For safety information the EN 61 010-1 + A2 standard must be observed.
This instrument is not explosion-safe!

TECHNICAL DATA

Measuring instruments of the OM 402 series conform to the European regulation 89/336/EWG and the Ordinance 168/1997 Coll.

The instruments are up to the following European standards:
EN 55 022, class B
EN 61000-4-2, -4, -5, -6, -8, -9, -10, -11

The instruments are applicable for unlimited use in agricultural and industrial areas.

CONNECTION

Supply of energy from the main line has to be isolated from the measuring leads.



ORBIT MERRET, spol. s r.o.

Vodnanska 675/30
198 00 Prague 9
Czech Republic

Tel: +420 - 281 040 200
Fax: +420 - 281 040 299
e-mail: orbit@merret.cz
www.orbit.merret.cz



1.	Contents	3
2.	Instrument description	4
3.	Instrument connection	6
4.	Instrument setting	8
	Symbols used in the instructions	10
	Setting the DP and the (-) sign	10
	Control keys function	11
	Setting/permitting items into "USER" menu	11
5.	Setting "LIGHT" menu	12
5.0	Description "LIGHT" menu	12
	Setting input - Type "DC"	16
	Setting input - Type "PM"	18
	Setting input - Type "DU"	20
	Setting input - Type "OHM"	22
	Setting input - Type "RTD - Pt"	24
	Setting input - Type "RTD - Cu"	26
	Setting input - Type "RTD - Ni"	28
	Setting input - Type "T/C"	30
	Selection of the instrument measuring range - Channel B, C, D	32
	Setting display projection - Channel B	34
	Setting display projection - Channel C	36
	Setting display projection - Channel D	38
	Setting Limits	40
	Setting analog output	42
	Selection of programming menu „LIGHT"/„PROFI"	44
	Restoration of manufacture setting	44
	Calibration - input range (DU)	45
	Selection of instrument menu language version	46
	Setting new access password	46
	Instrument identification	47
6.	Setting "PROFI" menu	48
6.0	Description of "PROFI" menu	48
6.1	"PROFI" menu - INPUT	
6.1.1	Resetting internal values	52
6.1.2	Setting measuring type, range, mode, rate,	53
6.1.3	Setting the Real Time	60
6.1.4	External input function selection	60
6.1.5	Optional accessory functions of the keys	62
6.2	"PROFI" menu - CHANNEL	
6.2.1	Setting measuring parameters (projection, filters, decimal point, description)	66
6.2.2	Setting mathematic functions	70
6.2.3	Selection of evaluation of min/max. value	74
6.3	"PROFI" menu - OUTPUT	
6.3.1	Setting data logging	76
6.3.2	Setting Limits	78
6.3.3	Setting data output	80
6.3.4	Setting analog output	82
6.3.5	Selection of display projection	84
6.4	"PROFI" menu - SERVICE	
6.4.1	Selection of programming menu „LIGHT"/„PROFI"	86
6.4.2	Restoration manufacture setting	87
6.4.3	Calibration - input range (DU)	88
6.4.4	Selection of instrument menu language version	88
6.4.5	Setting new access password	88
6.4.6	Instrument identification	89
7.	Setting items into "USER" menu	90
8.	Method of measuring of the cold junction	92
9.	Data protocol	93
10.	Error statements	94
12.	Table of symbols	95
12.	Technical data	96
13.	Instrument dimensions and instalation	98
14.	Certificate of guarantee	99

2.1 Description

The OM 402 model series are 4 digit panel programmable instruments designed for maximum efficiency and user comfort while maintaining their favourable price. Two models are available: UNI and PWR.

Type OM 402UNI is a multifunction instrument with the option of configuration for 7 various input options, easily configurable in the instrument menu. By further options of input modules it is feasible to measure larger ranges of DC voltage and current or increase the number of inputs up to 4 (applies for PM).

The instrument is based on an 8-bit microcontroller with a multichannel 24-bit sigma-delta converter, which secures high accuracy, stability and easy operation of the instrument.

The OM 402 is a multifunction instrument available in following types and ranges

type UNI

DC:	0...60/150/300/1200 mV
PM:	0...5 mA/0...20 mA/4...20 mA/±2 V/±5 V/±10 V/±40 V
OHM:	0...100 Ω/0...1 kΩ/0...10 kΩ/0...100 kΩ
RTD-Pt:	Pt 100/Pt 500/Pt 1000
RTD-Ni:	Ni 1 000/Ni 10 000
T/C:	J/K/T/E/B/S/R/N
DU:	Linear potentiometer (min. 500 Ω)

type UNI, option A

DC:	0...1 A/0...5 A/±30 V/±120 V/±500 V
------------	-------------------------------------

type UNI, option B (expansion by 3 more inputs)

PM:	3x 0...5 mA/0...20 mA/4...20 mA/±2 V/±5 V/±10 V/±40 V
------------	---

PROGRAMMABLE PROJECTION

Selection:	of type of input and measuring range
Measuring range:	adjustable as fixed or with automatic change
Setting:	manual, optional projection on the display may be set in the menu for both limit values of the input signal, e.g. input 0...20 mA > 0...850,0
Projection:	-9999...9999 (-99999...999999)

COMPENSATION

of conduct:	in the menu it is possible to perform compensation for 2-wire connection
of conduct in probe:	internal connection (conduct resistance in measuring head)
of CJC (T/C):	manual or automatic, in the menu it is possible to perform selection of the type of thermocouple and compensation of cold junctions, which is adjustable or automatic (temperature at the brackets)

LINEARIZATION

Linearization:*	by linear interpolation in 50 points (solely via OM Link)
-----------------	---

DIGITAL FILTERS

Exponen.average:	from 2...100 measurements
Rounding:	setting the projection step for display

MATHEMATIC FUCTIONS

Min/max. value:	registration of min./max. value reached during measurement
Tare:	designed to reset display upon non-zero input signal
Peak value:	the display shows only max. or min. value
Mat. operations:	polynome, 1/x, logarithm, exponential, power, root, sin x

EXTERNAL CONTROL

Lock:	control keys blocking
Hold:	display/instrument blocking
Tare:	tare activation/resetting tare to zero
Resetting MM:	resetting min/max value
Memory:	data storage into instrument memory

2.2 Operation

The instrument is set and controlled by five control keys located on the front panel. All programmable settings of the instrument are performed in three adjusting modes:

LIGHT	Simple programming menu - contains solely items necessary for instrument setting and is protected by optional number code
PROFI	Complete programming menu - contains complete instrument menu and is protected by optional number code
USER	User programming menu - may contain arbitrary items selected from the programming menu (LIGHT/PROFI), which determine the right (see or change) - access without password

All programmable parameters are stored in the EEPROM memory (they hold even after the instrument is switched off).



Complete instrument operation and setting may be performed via OM Link communication interface, which is a standard equipment of all instruments.

The operation program is freely accessible (www.orbit.merret.cz) and the only requirement is the purchase of OML cable to connect the instrument to PC. It is manufactured in version RS 232 and USB and is compatible with all ORBIT MERRET instruments. Another option for connection is with the aid of data output RS 232 or RS 485 (without the need of the OML cable).

The program OM LINK in „Basic“ version will enable you to connect one instrument with the option of visualization and archiving in PC. The OM Link „Standard“ version has no limitation of the number of instruments connected.

2.3 Options

Excitation is suitable for supplying power to sensors and transmitters. It has a galvanic separation.

Comparators are assigned to monitor one, two, three or four limit values with relay output. The user may select limits regime: LIMIT/DOSING/FROM-TO. The limits have adjustable hysteresis within the full range of the display as well as selectable delay of the switch-on in the range of 0...99,9 s. Reaching the preset limits is signalled by LED and simultaneously by the switch-on of the relevant relay.

Data outputs are for their rate and accuracy suitable for transmission of the measured data for further projection or directly into the control systems. We offer an isolated RS232 and RS485 with the ASCII or DIN MessBus protocol.

Analog outputs will find their place in applications where further evaluating or processing of measured data is required in external devices. We offer universal analog output with the option of selection of the type of output - voltage/current. The value of analog output corresponds with the displayed data and its type and range are selectable in Menu.

Measured data record is an internal time control of data collection. It is suitable where it is necessary to register measured values. Two modes may be used. FAST is designed for fast storage (40 records/s) of all measured values up to 8 000 records. Second mode is RTC, where data record is governed by Real Time with data storage in a selected time segment and cycle. Up to 250 000 values may be stored in the instrument memory. Data transmission into PC via serial interface RS232/485 and OM link.

The instrument supply leads should not be in proximity of the incoming low-potential signals.

Contactors, motors with larger input power should not be in proximity of the instrument.

The leads into the instrument input (measured quantity) should be in sufficient distance from all power leads and appliances. Provided this cannot be secured it is necessary to use shielded leads with connection to ground (bracket E).

The instruments are tested in compliance with standards for use in industrial area, yet we recommend to abide by the above mentioned principles.

MEASURING RANGES

Type	Input I	Input U
DC	0...60/150/300/1 200 mV	
PM	0...5/20 mA/4...20 mA	$\pm 2/\pm 5/\pm 10/\pm 40$ V
OHM	0...0,1/1/10/100 k Ω	
RTD-Pt	Pt 50/100/Pt 500/ Pt 1 000	
RTD-Cu	Cu 50/100	
RTD-Ni	Ni 1 000/10 000	
T/C	J/K/T/E/B/S/R/N/I	
DU	Linear potentiometer (min. 500 Ω)	

OPTION "A"

Type	Input I	Input U
DC	$\pm 0,1$ A/ $\pm 0,25$ A/ $\pm 0,5$ A to GND (C) ± 2 A/ ± 5 A to GND (B)	± 100 V/ ± 250 V/ ± 500 V to GND (C)

OPTION "B"

Type	Input 2, 3, 4/I	Input 2, 3, 4/U
PM	0...5/20 mA/4...20 mA	$\pm 2/\pm 5/\pm 10/\pm 40$ V

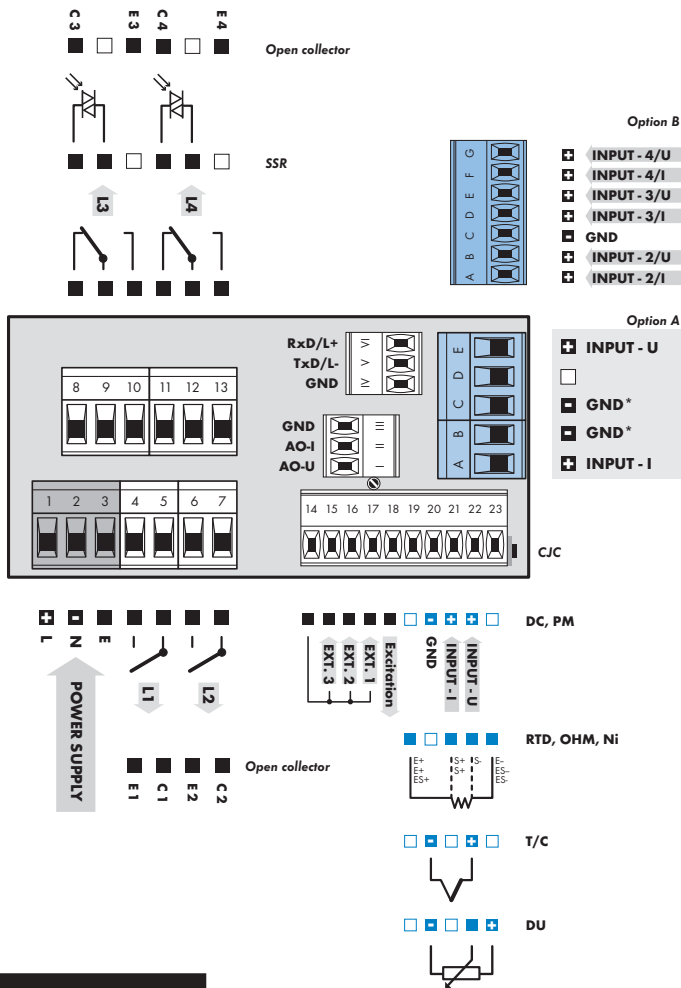

!
 Excitation has the minus pole common with the input - the bracket no. 20 - GND and you may set its value by trimmer above the bracket no. 17

PROFI

Setting

profi

- ▶ For expert users
- ▶ Complete instrument menu
- ▶ Access is password protected
- ▶ Possibility to arrange items of the „User“ menu
- ▶ Tree menu structure

LIGHT

Setting

light

- ▶ For trained users
- ▶ Only items necessary for instrument setting
- ▶ Access is password protected
- ▶ Possibility to arrange items of the „User“ menu
- ▶ Linear menu structure

USER

Setting

*profi light**user*

- ▶ For user operation
- ▶ Menu items are set by the user (Profi/Light) as per request
- ▶ Access is not password protected
- ▶ Optional menu structure either tree (PROFI) or linear (LIGHT)

4.1 Setting

The instrument is set and controlled by five control keys located on the front panel. All programmable settings of the instrument are performed in three adjusting modes:

- LIGHT** **Simple programming menu**
 - contains solely items necessary for instrument setting and is protected by optional number code
- PROFI** **Complete programming menu**
 - contains complete instrument menu and is protected by optional number code
- USER** **User programming menu**
 - may contain arbitrary items selected from the programming menu (LIGHT/PROFI), which determine the right (see or change)
 - access without password

All programmable parameters are stored in the EEPROM memory (they hold even after the instrument is switched off).

Complete instrument operation and setting may be performed via OM Link communication interface, which is a standard equipment of all instruments.

The operation program is freely accessible (www.orbit.merret.cz) and the only requirement is the purchase of OML cable to connect the instrument to PC. It is manufactured in version RS 232 and USB and is compatible with all ORBIT MERRET instruments.

Another option for connection is with the aid of data output RS 232 or RS 485 (without the need of the OML cable).

Scheme of processing the measured signal

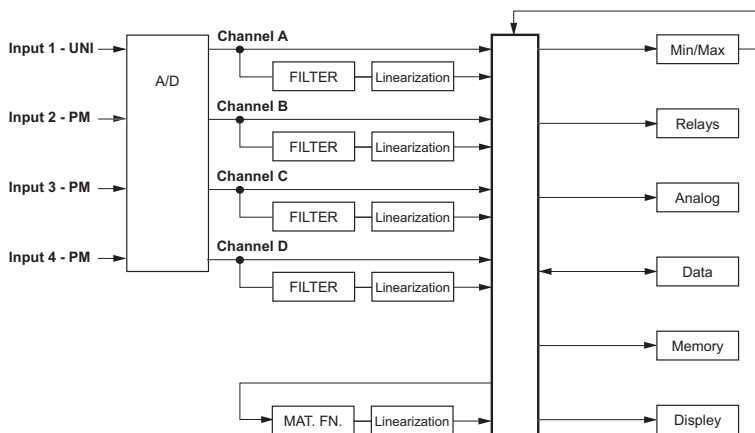

Setting and controlling the instrument is performed by means of 5 control keys located on the front panel. With the aid of these keys it is possible to browse through the operation menu and to select and set required values.

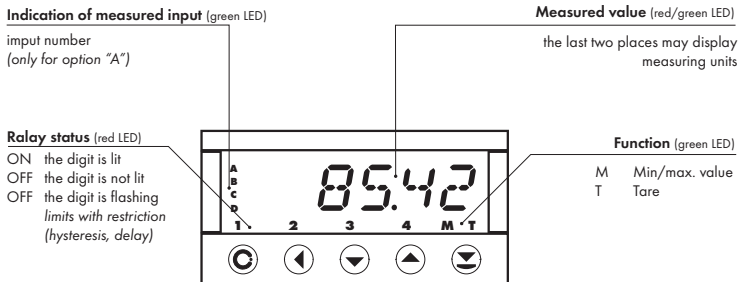

Symbols used in the instructions

DC **PM**
DU **OHM** **RTD** **T/C** Indicates the setting for given type of instrument

DEF values preset from manufacture

symbol indicates a flashing light (symbol)

inverted triangle indicates the item that can be placed in USER menu

broken line indicates a dynamic item, i.e. it is displayed only in particular selection/version

after pressing the key the set value will not be stored

after pressing the key the set value will be stored

30 continues on page 30

Setting the decimal point and the minus sign

DECIMAL POINT

Its selection in the menu, upon modification of the number to be adjusted it is performed by the control key with transition beyond the highest decade, when the decimal point starts flashing. Positioning is performed by / .

THE MINUS SIGN

Setting the minus sign is performed by the key on higher decade. When editing the item subtraction must be made from the current number (e.g.: 013 > , on class 100 > -87)

Control keys functions

Key	Measurement	Menu	Setting numbers/selection
	access into USER menu	exit menu	quit editing
	programmable key function	back to previous level	move to higher decade
	programmable key function	move to previous item	move down
	programmable key function	move to next item	move up
	programmable key function	confirm selection	confirm setting/selection
			numeric value is set to zero
	access into LIGHT/PROFI menu		
	direct access into PROFI menu		
		configuration of an item for "USER" menu	
		determine the sequence of items in "USER - LIGHT" menu	

Setting items into „USER“ menu

- in LIGHT or PROFI menu
- no items permitted in USER menu from manufacture
- on items marked by inverted triangle

user

Legend is flashing - current setting is displayed



- item will not be displayed in USER menu
- item will be displayed in USER menu with the option of setting
- item will be solely displayed in USER menu

5.0

Setting "LIGHT"

LIGHT**Simple programming menu**

- contains only items necessary for instrument setting and is protected by optional number code

SETTING LIGHT

light

- For capable users
- Only items necessary for instrument setting
- Access is password protected
- Possibility to arrange items of the „User“ menu
- Linear menu structure

Preset from manufacture

Password	"0"
Menu	LIGHT
USER menu	off
Setting the items	DEF

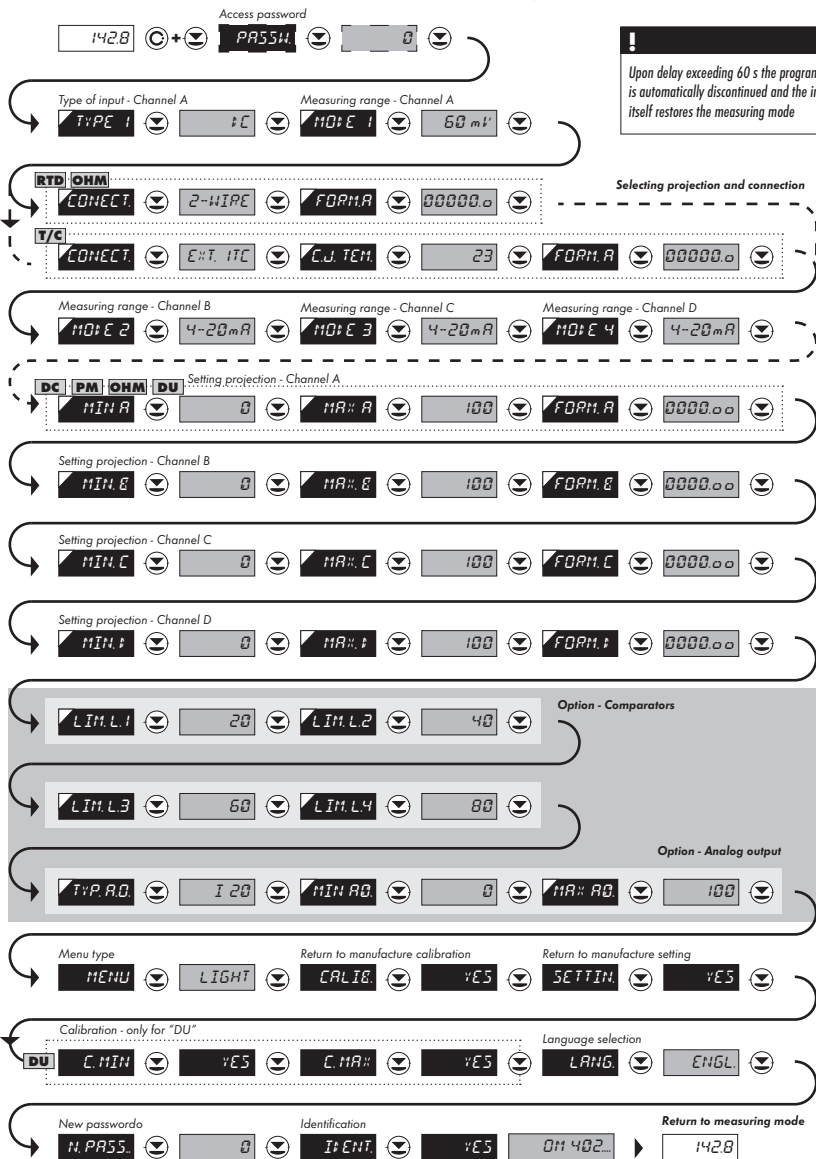

!
Upon delay exceeding 60 s the programming mode is automatically discontinued and the instrument itself restores the measuring mode

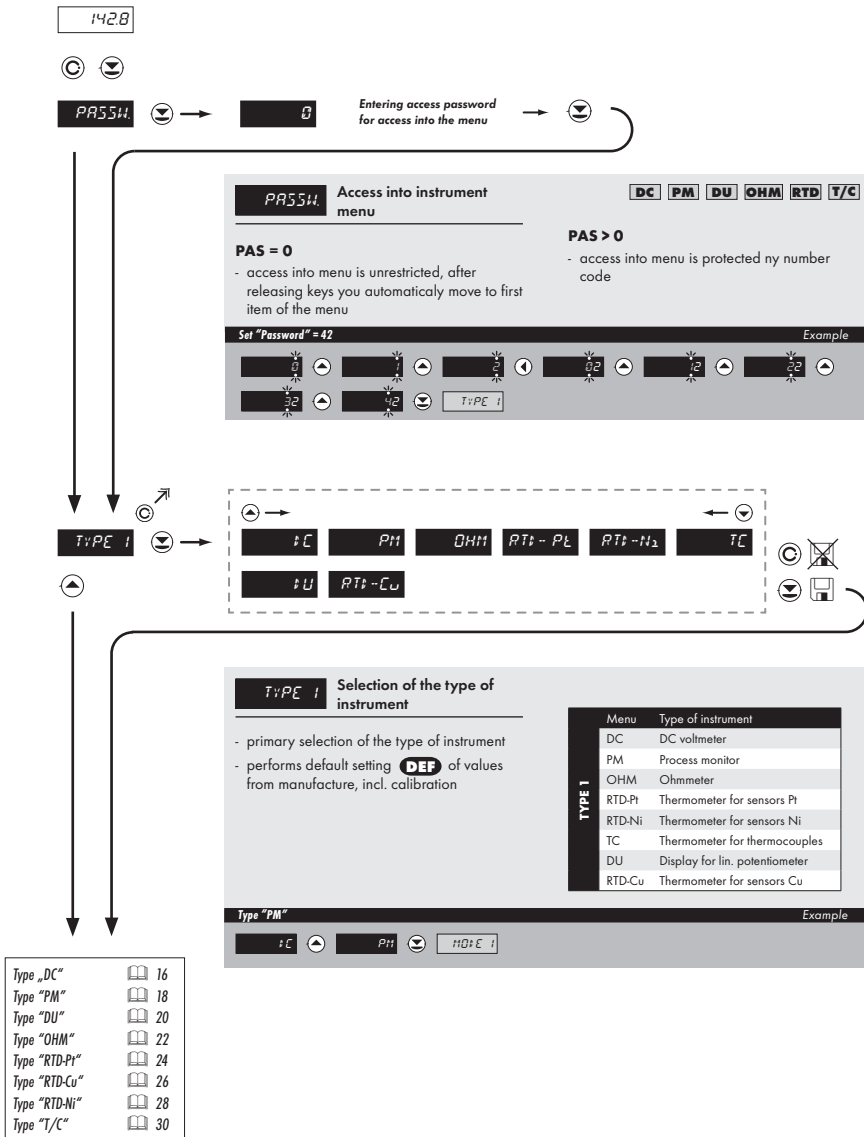

Type "DC"

H0: E 1



H0: E 1 Selection of the instrument measuring range

DEF = 60 mV

MODE1	Menu	Measuring range
	60 mV	±60 mV
	150 mV	±150 mV
	300 mV	±300 mV
	1200mV	±1,2 V

Range ±150 mV

Example

60 mV 150 mV H1: R

MIN A

0 Setting for minimum input signal



MIN A Setting display projection for minimum value of input signal

- range of the setting is -99999...999999

- position of the DP does not affect display projection
- the DP is automatically shifted after the value is confirmed

DEF = 0

Projection for 0 mV > MIN A = 0

Example

0 H1: R

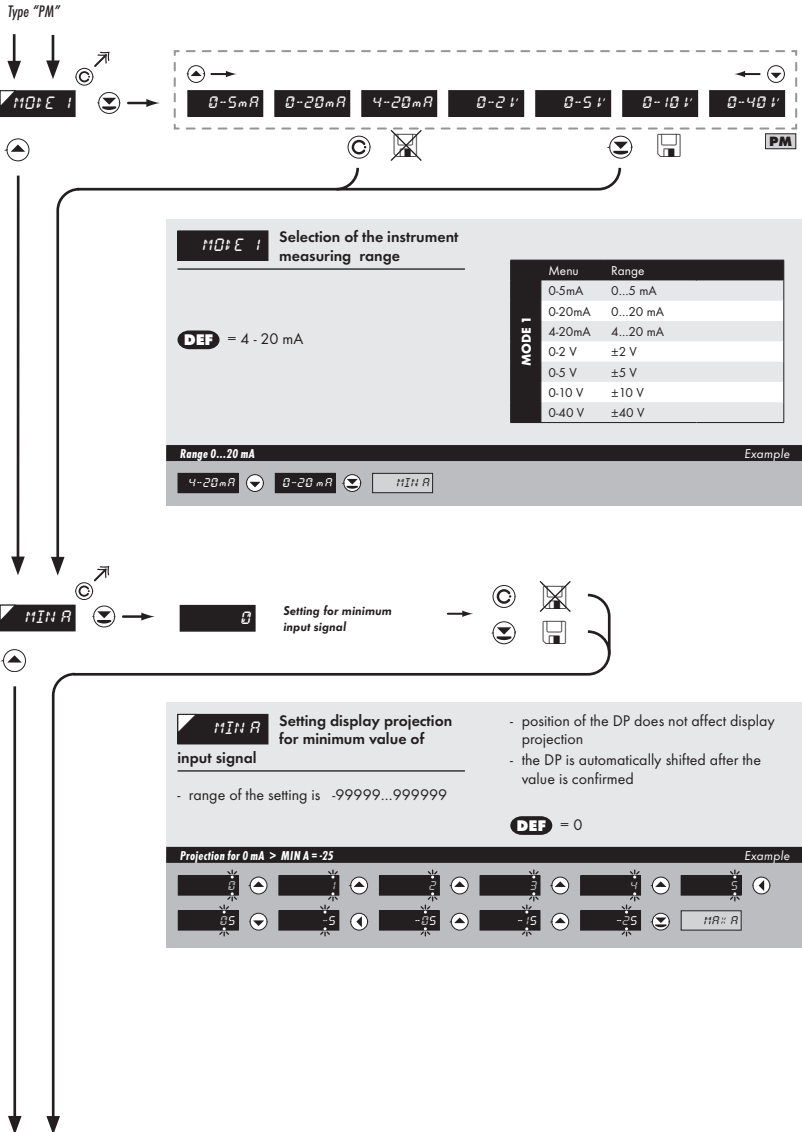



MAX: R Setting display projection for maximum value of input signal

- position of the DP does not affect display projection
- the DP is automatically shifted after the value is confirmed

DEF = 100

Projection for 20 mA > MAX A = 2500 Example

100	100	100	200	300	400
500	500	500	500	FORM: R	

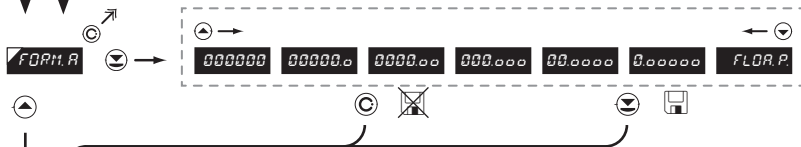

FORM: R Setting projection of the decimal point

DEF = 0000.00

- positioning of the DP is set here in the measuring mode

Projection of DP on display > 00000.0 Example

0000.00	00000.0	HELD
---------	---------	------

* subsequent item on the menu depends on instrument equipment

Type "OHM"

100 E 1

100 R 1 k 10 k 100 k OHM

MODE 1

Menu	Measuring range
100 R	0...100 Ω
1 k	0...1 kΩ
10 k	0...10 kΩ
100 k	0...100 kΩ

DEF = 100 Ω

Range 0...10 kΩ Example

100 R 1 k 10 k CONECT

CONECT

2-WIRE 3-WIRE 4-WIRE

CONECT.

Menu	Connection
2-WIRE	2-wire
3-WIRE	3-wire
4-WIRE	4-wire

DEF = 2-WIRE

Type of connection - 3-wire > CONECT. = 3-WIRE Example

2-WIRE 3-WIRE MIN A

MIN A

Setting for minimum input signal

DEF = 0

MIN A

Setting display projection for minimum value of input signal

- range of the setting is -99999...999999
- position of the DP does not affect display projection
- the DP is automatically shifted after the value is confirmed

DEF = 0

Projection for 0 Ohm > MIN A = 0 Example

0 MIN A



11A: A Setting display projection for maximum value of input signal

- range of the setting is -99999...999999

DEF = 100

Projection for 10 kOhm > MAX A = 10000 Example

100	100	00	000	0000	00000
00000	FORM A				

- position of the DP does not affect display projection
- the DP is automatically shifted after the value is confirmed

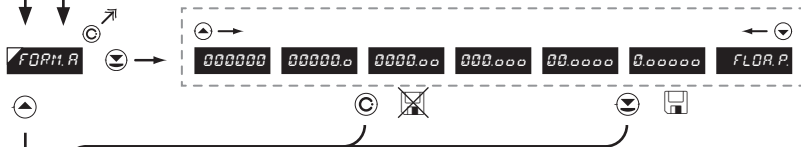

FORM A Setting projection of the decimal point

- positioning of the DP is set here in the measuring mode

DEF = 0000.00

Projection of DP on display > 00000.0 Example

0000.00	00000.0	11E1U
---------	---------	-------

* subsequent item on the menu depends on instrument equipment

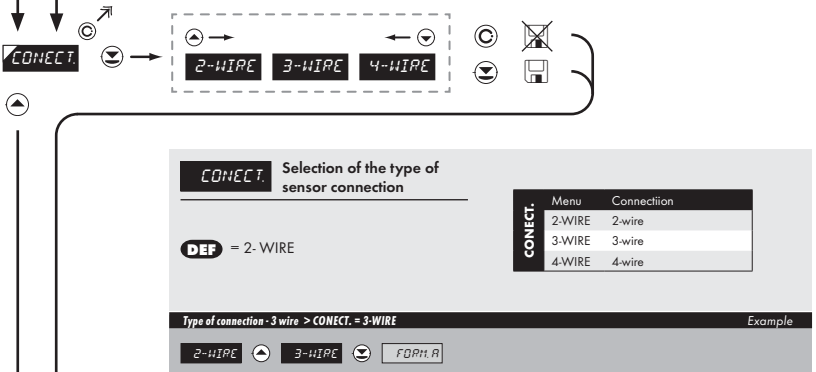
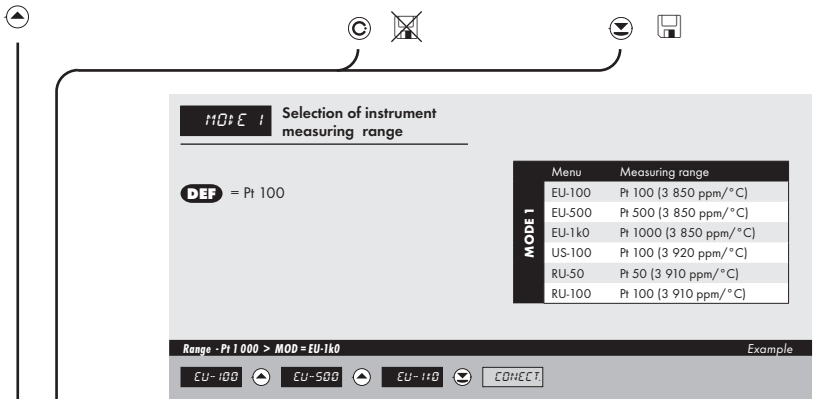



FORM.R Setting projection of the decimal point **DEF** = 00000.0

- positioning of the DP is set here in the measuring mode

Projection of DP on display > 000000 *Example*

00000.0 000000 MENU * subsequent item on the menu depends on instrument equipment

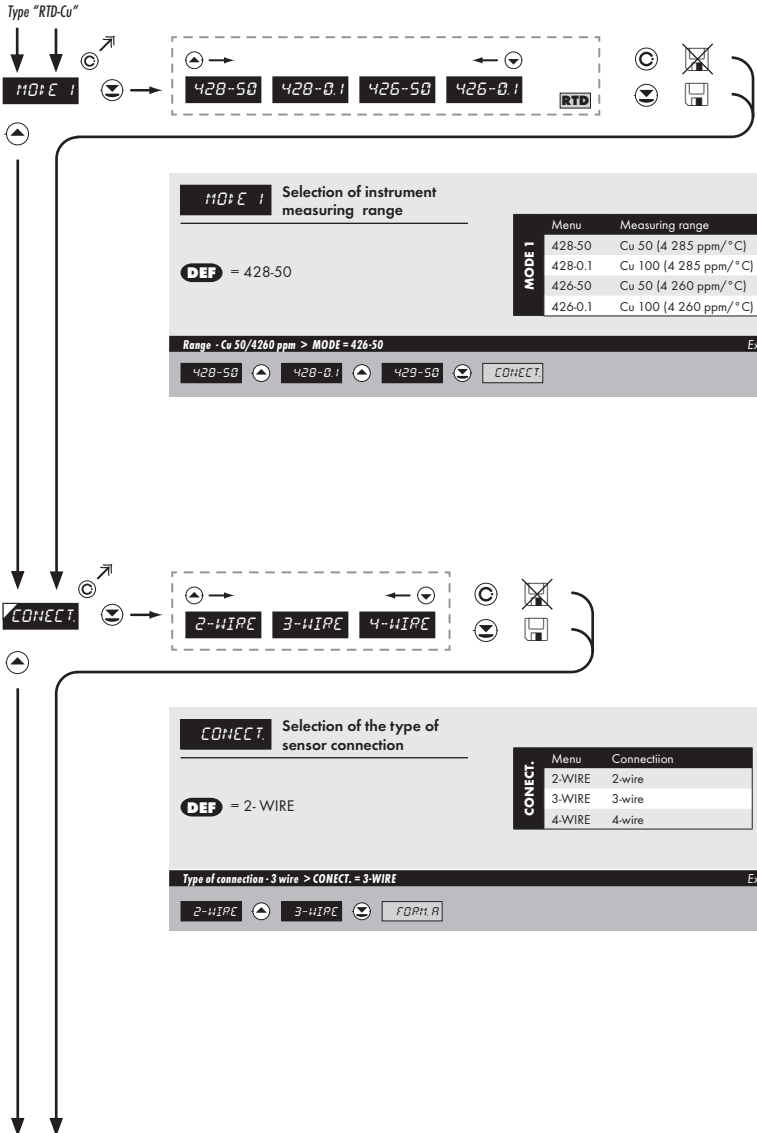



FORM.R Setting projection of the decimal point **DEF** = 00000.0

- positioning of the DP is set here in the measuring mode

Projection of DP on display > 000000 Example

00000.0 000000 MENU * subsequent item on the menu depends on instrument equipment



Type "RTD-Ni"



MODE 1

Selection of instrument measuring range

DEF = Ni 1 000 - 5 000 ppm/°C

Menu	Measuring range
5.0-1k	Ni 1 000 (5 000 ppm/°C)
6.2-1k	Ni 1 000 (6 180 ppm/°C)
5.0-10k	Ni 10 000 (5 000 ppm/°C)
6.2-10k	Ni 10 000 (6 180 ppm/°C)

Range - Pt 1 000 > MODE = EU-1k0

Example

EU-100

EU-500

EU-1k0

CONNECT



CONNECT

Selection of the type of sensor connection

DEF = 2-WIRE

CONNECT	Menu	Connection
	2-WIRE	2-wire
	3-WIRE	3-wire
	4-WIRE	4-wire

Type of connection - 3-wire > CONNECT = 3-WIRE

Example

2-WIRE

3-WIRE

FORM A



C.J. TEM Setting temperature of cold junction **DEF** = 23

- range 0...99 °C with compensation box

Setting temperature of cold junction > C.J. TEM. = 35 Example

23 24 25 35 FORM.A



FORM.A Setting projection of the decimal point **DEF** = 00000.0

- positioning of the DP is set here in the measuring mode

Projection of DP on display > 000000 Example

00000.0 00000.00 THELU * subsequent item on the menu depends on instrument equipment

!
For thermocouple type "B" the items **CONNECT.** and **C.J. TEM.** are not available

!
Method and procedure of setting the cold junctions is described in separate chapter on page 92

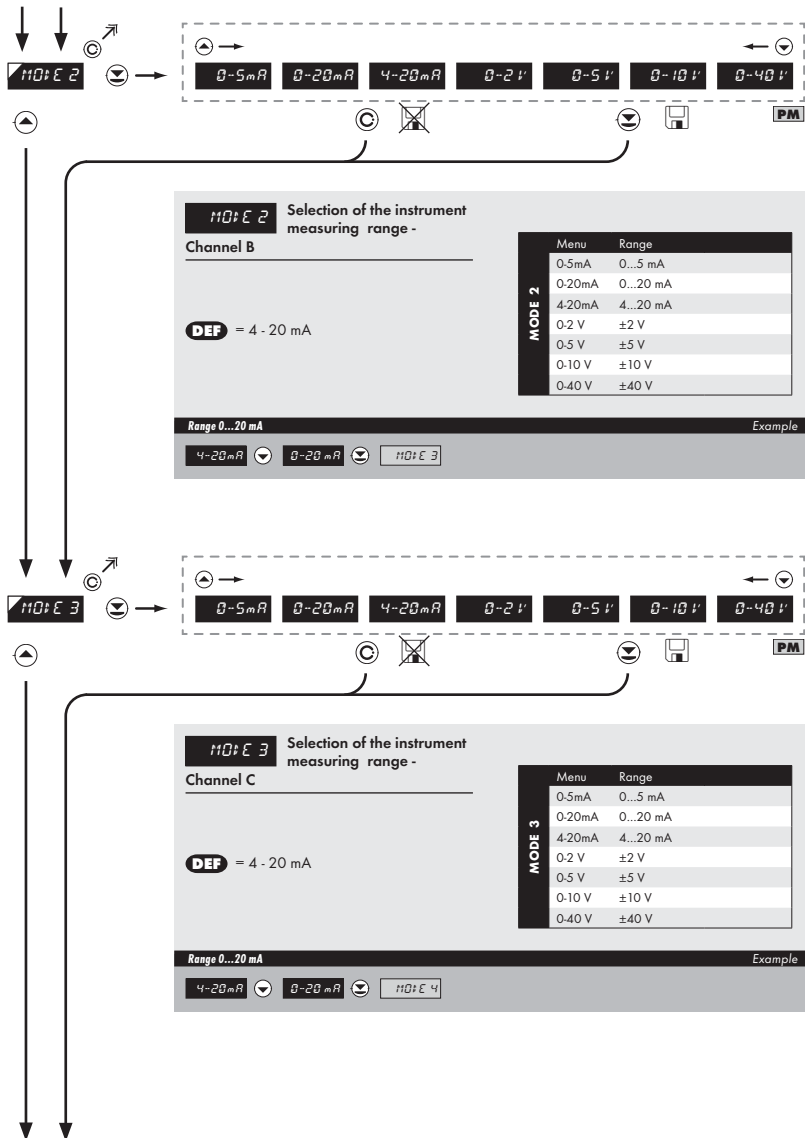

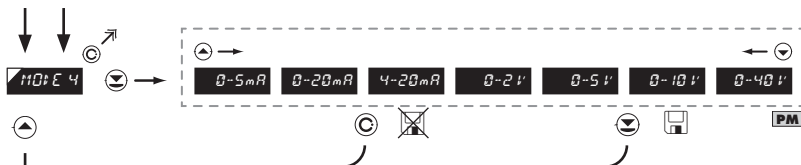

110: E 4 Selection of the instrument measuring range -

Channel D

DEF = 4 - 20 mA

MODE 4	Menu	Range
	0-5mA	0...5 mA
	0-20mA	0...20 mA
	4-20mA	4...20 mA
	0-2 V	±2 V
	0-5 V	±5 V
	0-10 V	±10 V
	0-40 V	±40 V

Range 0...20 mA Example

4-20 mA 0-20 mA 110: E

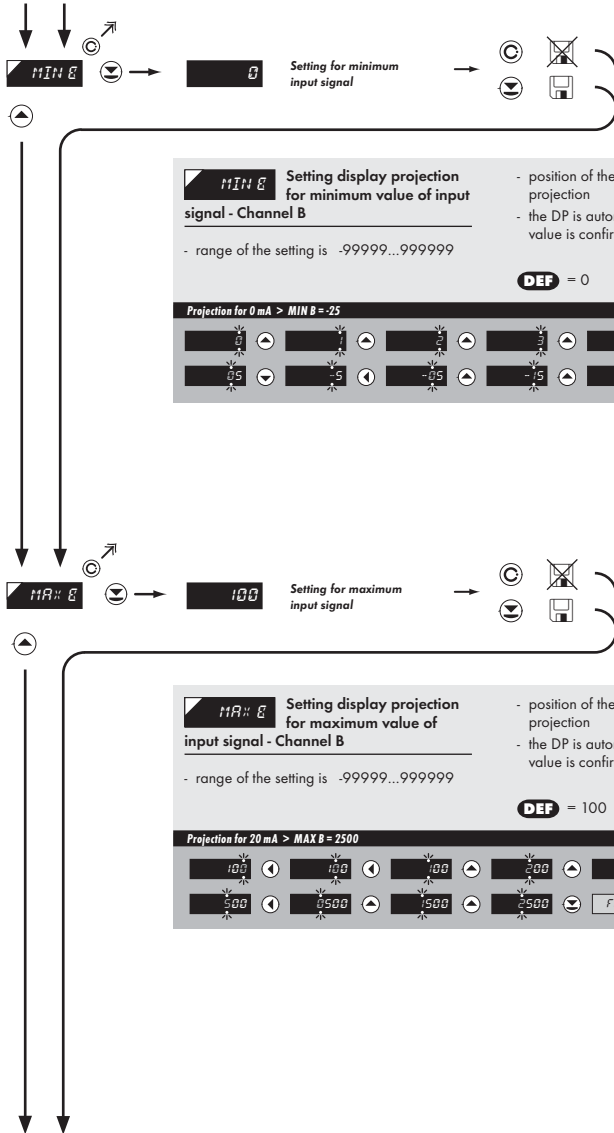



MIN C Setting display projection for minimum value of input signal - Channel C

- range of the setting is -99999...999999

- position of the DP does not affect display projection
- the DP is automatically shifted after the value is confirmed

DEP = 0

Projection for 0 mA > MIN C = 25

Example



MAX C Setting display projection for maximum value of input signal - Channel C

- range of the setting is -99999...999999

- position of the DP does not affect display projection
- the DP is automatically shifted after the value is confirmed

DEP = 100

Projection for 20 mA > MAX C = 2500

Example



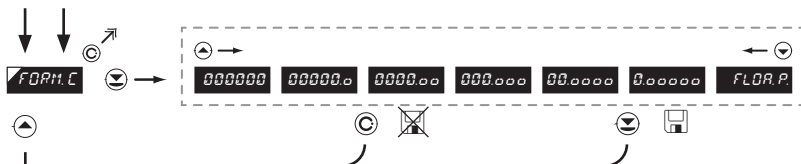

FORM.C Setting projection of the decimal point - Channel C **DEF** = 0000.00

- positioning of the DP is set here in the measuring mode

Projection of DP on display > 00000.0 Example

0000.00 00000.0



MIN Setting display projection for minimum value of input signal - Channel D

- range of the setting is -99999...999999

- position of the DP does not affect display projection
- the DP is automatically shifted after the value is confirmed

DEP = 0

Projection for 0 mA > MIN D = -25

Example



MAX Setting display projection for maximum value of input signal - Channel D

- range of the setting is -99999...999999

- position of the DP does not affect display projection
- the DP is automatically shifted after the value is confirmed

DEP = 100

Projection for 20 mA > MAX D = 2500

Example



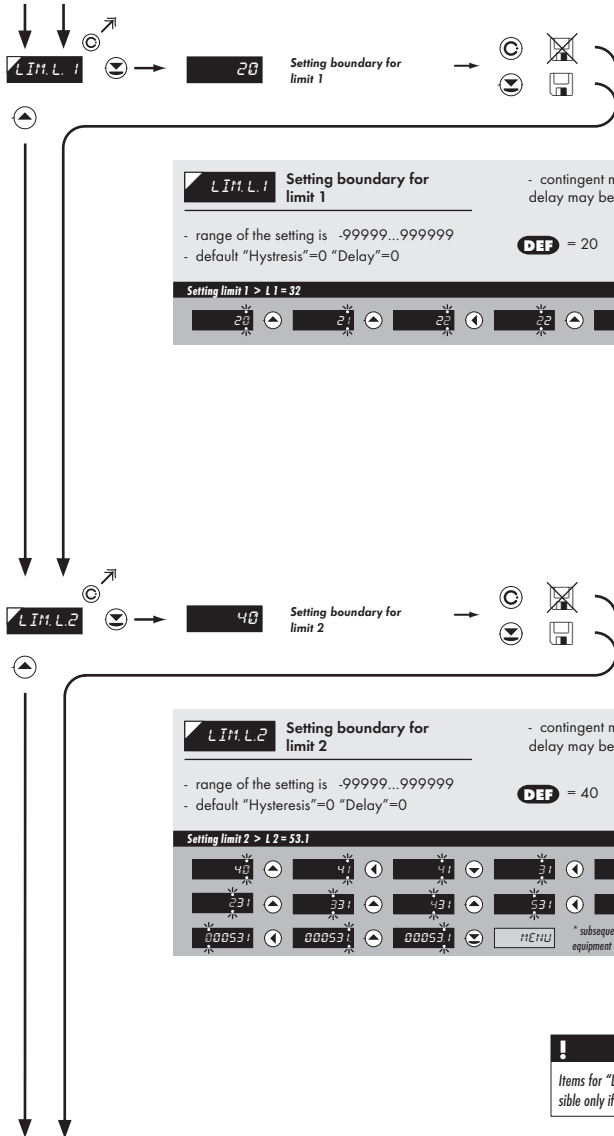

! Items for "Limits" and "Analog output" are accessible only if incorporated in the instrument.



LIM.L3 Setting boundary for limit 3

- range of the setting is -99999...999999
- default "Hysteresis"=0 "Delay"=0

DEF = 60

Setting limit 3 > L3 = 85 Example

60	61	62	63	64	65
65	75	85	11E+11		

* subsequent item on the menu depends on instrument equipment



LIM.L4 Setting boundary for limit 4

- range of the setting is -99999...999999
- default "Hysteresis"=0 "Delay"=0

DEF = 80

Setting limit 4 > L4 = 103 Example

80	81	82	83	84	85
83	103	103	11E+11		

* subsequent item on the menu depends on instrument equipment

TYP.A.O. Setting the type of analog output

Menu	Range	Description
0-20mA	0...20 mA	
E. 4-20mA	4...20 mA	with indication of error statement (<3,6 mA)
4-20mA	4...20 mA	
0.5mA	0...5 mA	
0.2 V	0...2 V	
0.5 V	0...5 V	
0-10 V	0...10 V	

DEF = 4...20 mA

Type of analog output - 0...10 V > TYP.A.O. = U 10 Example

4-20mA 0-5mA 0-2V 0-5V 0-10V MIN.A.O.

MIN.A.O. Assigning the display value to the beginning of the AO range

DEF = 0

- range of the setting is -99999...999999

Display value for the beginning of the AO range > MIN.A.O. = 0 Example

MIN.A.O.

!

Items for "Limits" and "Analog output" are accessible only if incorporated in the instrument.

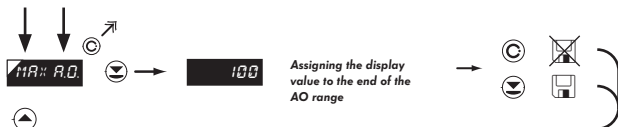

11A:: R.O. Assigning the display value to the end of the AO range **DEF** = 100

- range of the setting is -99999...999999

Display value for the end of the AO range > MAX.A.O. = 120 Example

100 100 110 120 MENU

Displayed only with options > **Analog output**

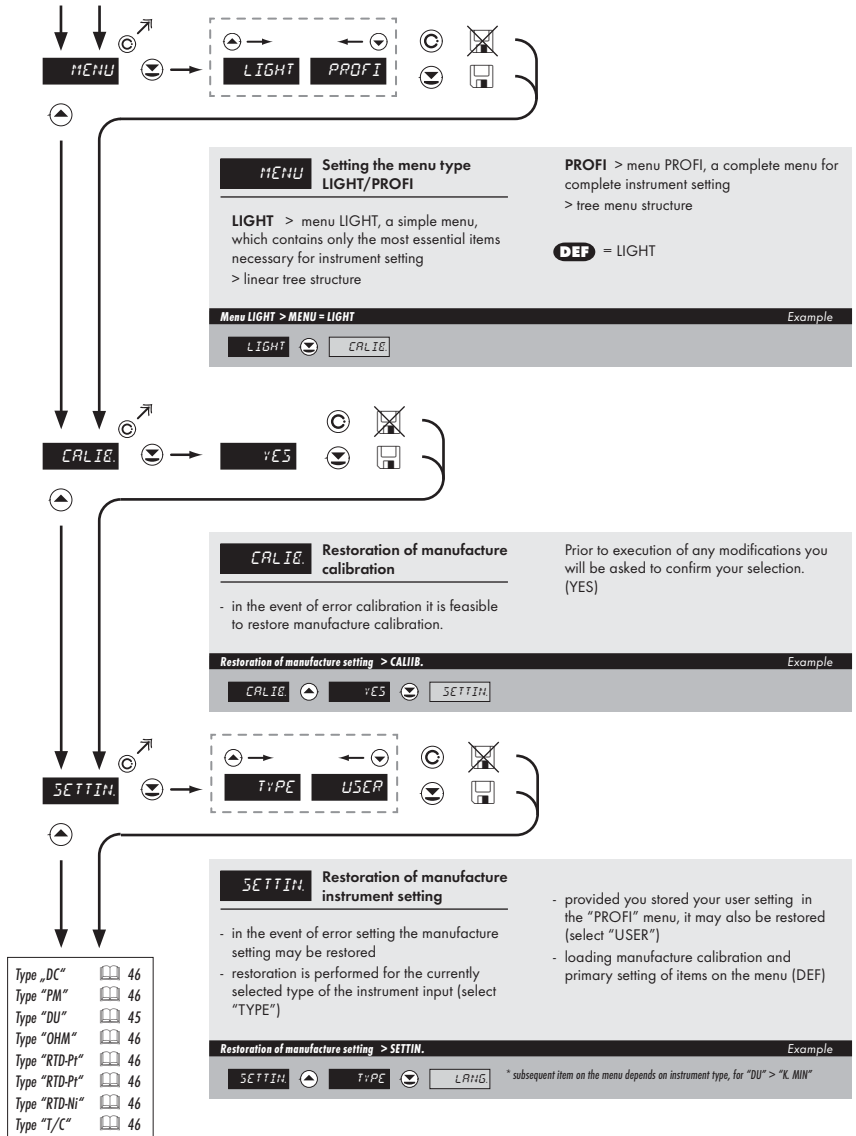

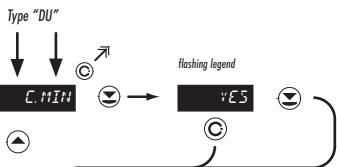

C. MIN Calibration of input range - the potentiometer traveller in initial position Only for type "DU"

- prior confirming the flashing "YES" sign the potentiometer traveller has to be in given idle position

Calibration of the beginning of the range > C. MIN Example

YES

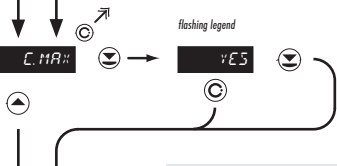

C. MAX Calibration of input range - the potentiometer traveller in end position Only for type "DU"

- prior confirming the flashing "YES" sign the potentiometer traveller has to be in given idle position

Calibration of the end of the range > C. MAX Example

YES



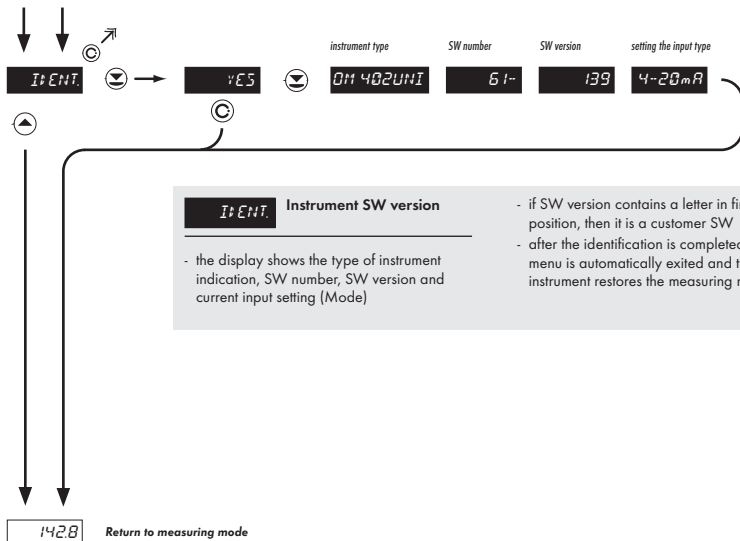

***I:ENT.* Instrument SW version**

- if SW version contains a letter in first position, then it is a customer SW
- after the identification is completed the menu is automatically exited and the instrument restores the measuring mode

- the display shows the type of instrument indication, SW number, SW version and current input setting (Mode)

6.0

Setting "PROFI"

PROFI

Complete programming menu

- contains complete instrument menu and is protected by optional number code
- designed for expert users
- preset from manufacture is menu **LIGHT**

SETTING
PROFI

- For expert users
- Complete instrument menu
- Access is password protected
- Possibility to arrange items of the „User“ menu
- Tree menu structure

Switching over to "PROFI" menu



- temporary switch-over to **PROFI** menu, which is suitable to edit a few items
- after quitting **PROFI** menu the instrument automatically switches to **LIGHT** menu
- access is password protected (if it was not set under item N. PASS. =0)



- access into **LIGHT** menu and transition to item „MENU“ with subsequent selection of „PROFI“ and confirmation
- after re-entering the menu the **PROFI** type is active
- access is password protected (if it was not set under item N. PASS. =0)

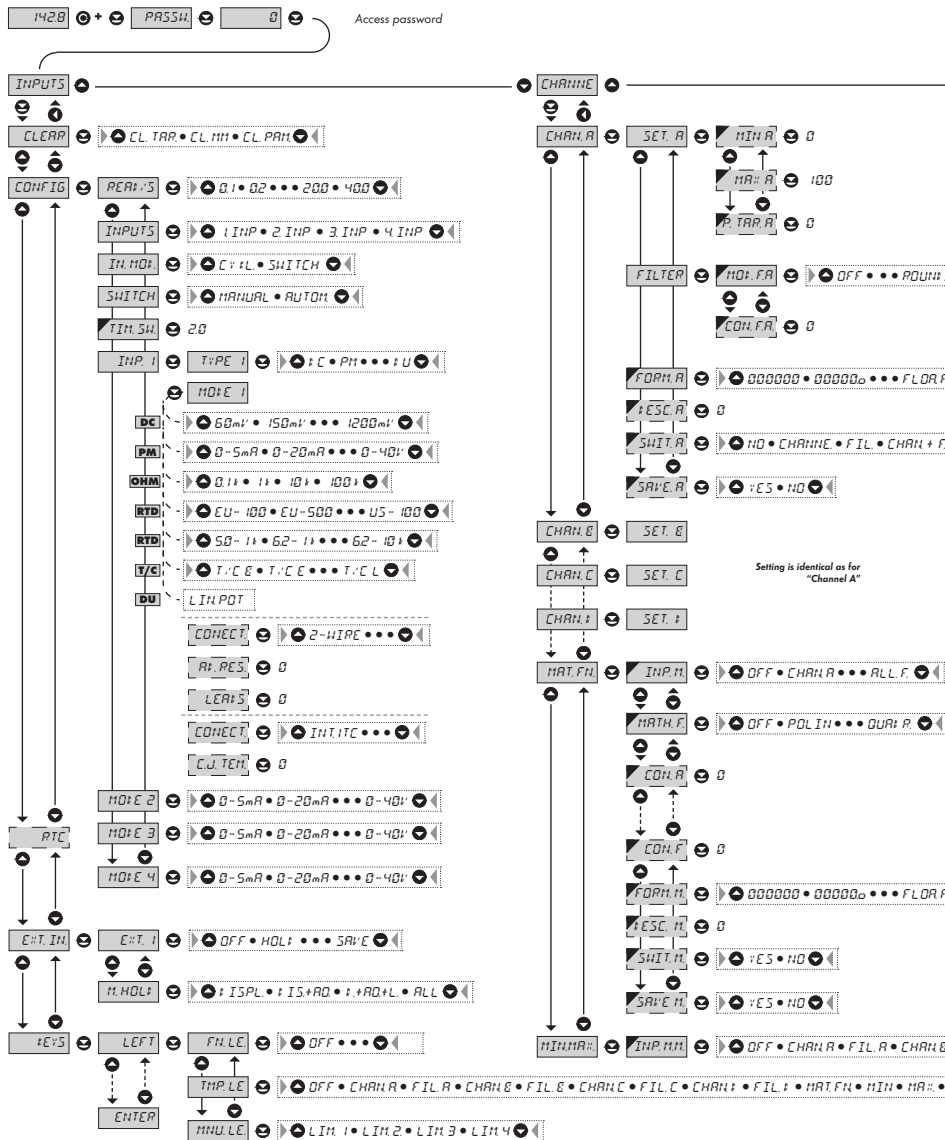

6.1 Setting "PROFI" - INPUT

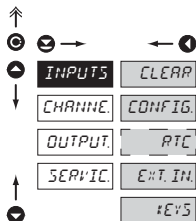

The primary instrument parameters are set in this menu

CLEAR	Resetting internal values
CONFIG	Selection of measuring range and parameters
RTC	Setting date and time for option with RTC
EXT. IN	Setting external inputs functions
EYS	Assigning further functions to keys on the instrument

6.1.1 Resetting internal values

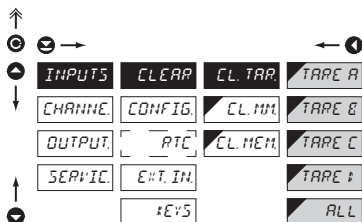

CL. TAR.	Resetting TARE
TARE A	Tare resetting - Channel A
TARE B	Tare resetting - Channel B
TARE C	Tare resetting - Channel C
TARE D	Tare resetting - Channel D
ALL	Tare resetting - Channel A, B, C and D
CL. MIN	Resetting min/max value
- resetting memory for the storage of minimum and maximum value achieved during measurement	
CL. MEM	Resetting the instrument memory
- resetting memory with data measured in the "FAST" or "RTC" modes	
- not in standard equipment	

6.1.2a Selection of measuring rate

INPUTS	CLEAR	REAR:RS	40.0
CHANNEL	CONFIG	INPUTS	20.0
OUTPUT	RTIC	IN.MOD	10.0
SERVIC	EXT.IN	SWITCH	5.0
	REYS	TIM.SH	2.0
		INP.1	1.0
		MOD:E 2	0.5
		MOD:E 3	0.2
		MOD:E 4	0.1

REAR:RS Selection of measuring rate

- measuring rate very significantly affects the number of active inputs "INPUTS" and evaluation mode "IN.MOD." (the factual measuring rates are listed in chapter Technical data)

40.0	40,0 measurements/s
20.0	20,0 measurements/s
10.0	10,0 measurements/s
5.0	5,0 measurements/s
2.0	2,0 measurements/s
1.0	1,0 measurement/s
0.5	0,5 measurements/s
0.2	0,2 measurements/s
0.1	0,1 measurements/s

6.1.2b Selection of the number of active inputs

INPUTS	CLEAR	REAR:RS	1.INP.
CHANNEL	CONFIG	INPUTS	2.INP.
OUTPUT	RTIC	IN.MOD	3.INP.
SERVIC	EXT.IN	SWITCH	4.INP.
	REYS	TIM.SH	
		INP.1	
		MOD:E 2	
		MOD:E 3	
		MOD:E 4	

INPUTS Selection of the number of active inputs

- measuring rate depends on the number of active inputs (the factual measuring rates are listed in chapter Technical data)

1.INP.	Active input 1
2.INP.	Active inputs 1 and 2
3.INP.	Active inputs 1, 2 and 3
4.INP.	Active inputs 1, 2, 3 and 4

6.1.2c Selection of measuring mode for multichannel instrument

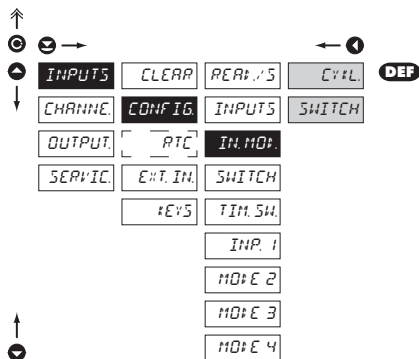
IN.MOD. Selection of measuring mode in multichannel instrument

CYCL Cyclic measuring on all channels

- instrument evaluates measured data simultaneously on all channels
- selection of cycle very significantly affects measuring rate and depends also on the number of active inputs (factual measuring rates are listed in the chapter Technical data)

SWITCH Measuring on selected channel

- instrument evaluates measured data only on selected channel

6.1.2d Selection of inputs switching

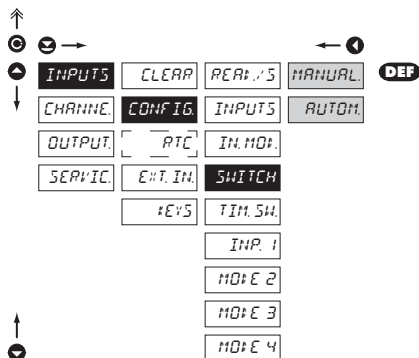
SWITCH Selection of inputs switching

MANUAL Manual inputs switching

- inputs switching is controlled by selected key on the front panel or selected external input

AUTOM. Automatic inputs switching

- inputs switching is automatic in a time period set in "TIM. SW."

6.1.2e Setting the period for inputs switching

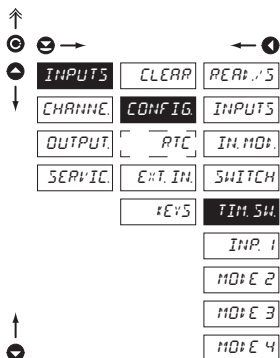

TIM SW Setting the period for inputs switching

- setting the time period for projection of channels in automatic mode of inputs switching ("AUTOM.")
- range of setting 0,5...99,9 s

DEF TIM. SW. = 2 s

6.1.2f Selection of „instrument“ type for channel A

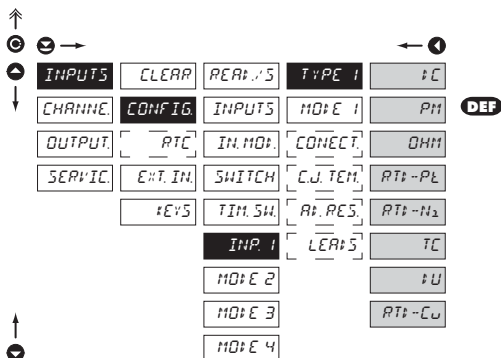

TYPE 1 Selection of „instrument“ type for channel A

- selection of particular type of "instrument" is bound to relevant dynamic items

#C	DC voltmeter
PH	Process monitor
OHM	Ohmmeter
RTI-PL	Thermometer for Pt xxx
RTI-N1	Thermometer for Ni xxxx
TC	Thermometer pro thermocouples
#U	Display for linear potentiometers
RTI-CU	Thermometer for Cu xxx

6.1.2g Selection of measuring range for channel A

↑

⊖ →

⊖ ↓

DC ← 1

INPUTS	CLEAR	REAR:5	TYPE 1	60mV
CHANNEL	CONFIG	INPUTS	MODE 1	150mV
OUTPUT	PTC	INH.MO:	CONNECT	300mV
SERVIC	EXT.IN	SWITCH	CU.TEM	1200mV
	KEYS	TIM.SW	RT.PRES	
		INP. 1	LEAS	0-5mR
		MODE 2		0-20mR
		MODE 3		4-20mR DEF
		MODE 4		0-2 V
				0-5 V
				0-10 V
				0-40 V

PM

OHM

RTD-PT **DEF**

EU-100	428-50 DEF
EU-500	428-0.1
EU-1k0	426-50
US-100	426-0.1
RU-50	
RU-100	

RTD-Cu

RTD-Ni

50-1k	50-1k DEF
6.2-1k	
50-10k	
6.2-10k	

OHM **DEF**

100 R	DEF
1 k	
10 k	
100 k	

T/C

T/C B	
T/C E	
T/C J	
T/C K	
T/C N	
T/C R	
T/C S	
T/C T	

DU **DEF**

LIN.POT.	DEF
----------	------------

↑

⊖

MODE 1 Selection of instrument measuring range

Menu	Measuring range
60 mV	±60 mV
150 mV	±150 mV
300 mV	±300 mV
1200mV	±1,2 V

Menu	Measuring range
0.5mA	0..5 mA
0.20mA	0..20 mA
4.20mA	4..20 mA
0.2 V	±2 V
0.5 V	±5 V
0.10 V	±10 V
0.40 V	±40 V

Menu	Measuring range
100 R	0..100 Ω
1 k	0..1 kΩ
10 k	0..10 kΩ
100 k	0..100 kΩ
AUTO	Automatická změna rozsahu

Menu	Measuring range
EU-100	Pt 100 (3 850 ppm/°C)
EU-500	Pt 500 (3 850 ppm/°C)
EU-1k0	Pt 1000 (3 850 ppm/°C)
US-100	Pt 100 (3 920 ppm/°C)
RU-50	Pt 50 (3 910 ppm/°C)
RU-100	Pt 100 (3 910 ppm/°C)

Menu	Measuring range
5.0-1k	Ni 1 000 (5 000 ppm/°C)
6.2-1k	Ni 1 000 (6 180 ppm/°C)
5.0-10k	Ni 10 000 (5 000 ppm/°C)
6.2-10k	Ni 10 000 (6 180 ppm/°C)

Menu	Measuring range
428-50	Cu 50 (4 280 ppm/°C)
428-0.1	Cu 1 00 (4 280 ppm/°C)
426-50	Cu 50 (4 260 ppm/°C)
426-0.1	Cu 100 (4 260 ppm/°C)

Menu	Type of thermocouple
T/C B	B
T/C E	E
T/C J	J
T/C K	K
T/C N	N
T/C R	R
T/C S	S
T/C T	T

6.1.2h Selection of type of sensor connection for channel A

RTD **OHM** **T/C**

↑
 Ⓞ →
 ▲ INPUTS CLEAR RECAL: S TYPE 1 2-WIRE DEF
 ↓ CHANNEL CONFIG INPUTS MODE 1 3-WIRE
 OUTPUT RTD IN. MOD. CONNECT 4-WIRE
 SERIAL EXT. IN. SWITCH AD. RES.
 KEYS TIM. SH. LEAR: S.
 INP. 1
 MODE 2
 MODE 3
 MODE 4

↑
 Ⓞ →
 ▲ INPUTS CLEAR RECAL: S TYPE 1 INT. ITC
 ↓ CHANNEL CONFIG INPUTS MODE 1 INT. 2TC
 OUTPUT RTD IN. MOD. CONNECT EXT. ITC DEF
 SERIAL EXT. IN. SWITCH C.J. TEM. EXT. 2TC
 KEYS TIM. SH.
 INP. 1
 MODE 2
 MODE 3
 MODE 4

CONNECT Selection of type of sensor connection

RTD **OHM**

2-WIRE 2-wire connection

3-WIRE 3-wire connection

4-WIRE 4-wire connection

T/C

INT. ITC Measurement without reference thermocouple
 - measuring cold junction at instrument brackets

INT. 2TC Measurement with reference thermocouple
 - measuring cold junction at instrument brackets with anti-series connected reference thermocouple

EXT. ITC Measurement without reference thermocouple
 - the entire measuring set is working under invaried and constant temperature

EXT. 2TC Measurement with reference thermocouple
 - when using compensation box



Method and procedure of setting the cold junctions is described in separate chapter on page 92



For thermocouple type "B" the items CONNECT. and C.J. TEM. are not available

6.1.2i Setting temperature of cold junction

T/C

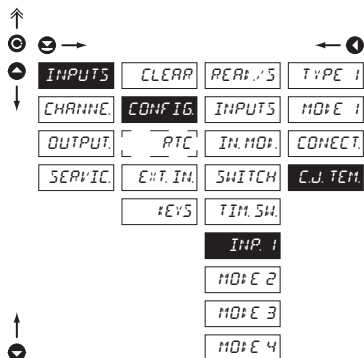
C.J. TEM. Setting temperature of cold junction

- range 0...99 °C with compensation box
- **DEF** = 23 °C

6.1.2j Compensation of 2-wire conduct

RTD OHM

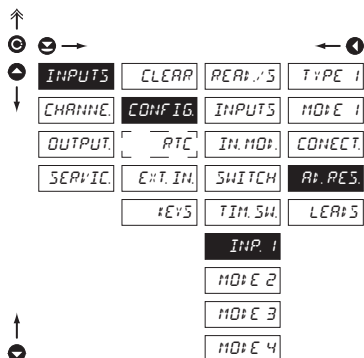
RT. RES. Offset of the beginning of the measuring range

- in cases when it is necessary to offset the beginning of the range by certain value, e.g. while using sensor in measuring head
- entered directly in Ohm (0...9999)
- **DEF** = 0

6.1.2k Compensation of 2-wire conduct

RTD OHM

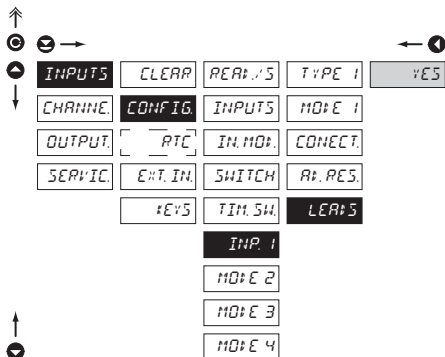

LEAR:5 Compensation of 2-wire conduct

- for measurement accuracy it is necessary to perform compensation of conduct always in case of 2-wire connection
- prior confirmation of the displayed prompt „YES“ it is necessary to substitute the sensor at the end of the conduct by a short-circuit
- **DEF** = 0

6.1.2l Selection of measuring range for channel B

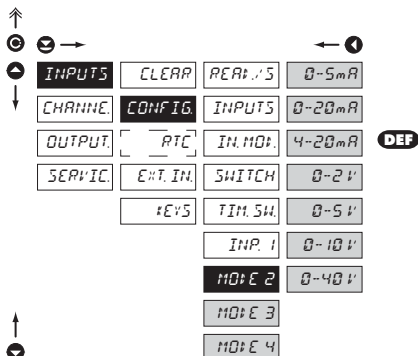

MODE 2 Selection of instrument measuring range for channel B

	Menu	Range
PM	0-5mA	0...5 mA
	0-20mA	0...20 mA
	4-20mA	4...20 mA
	0-2 V	±2 V
	0-5 V	±5 V
	0-10 V	±10 V
	0-40 V	±40 V

*
Setting procedure is identical for MOD. 3 and MOD. 4

6.1.3 Setting the real time clock

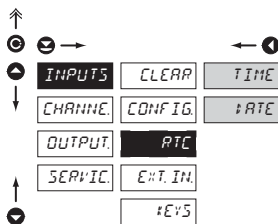

RTC Setting the real time clock (RTC)

TIME Time setting

- format 23.59.59

DATE Date setting

- format DD.MM.YY

6.1.4a External input function selection

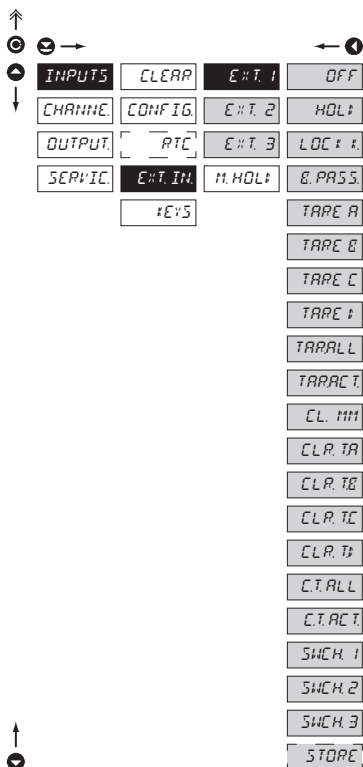

EXT. IN External input function selection

OFF Input is off

HOLD Activation of HOLD

LOCK Key Locking keys on the instrument

LOCK Access to locking access into programming menu LIGHT/PROFI

TARE Tare activation

- TARE A, B, C, D, All, Active

CL. MIN Resetting min/max value

CL. - Tare resetting

- TARE A, B, C, D, All, Active

SWCH. 1 Successive switching of channel projection

SWCH. 2 BCD switching of channel projection - EXT. 1, 2

- for operation see the table
- following this choice the setting for "EXT. 2" is automatically restricted

SWCH. 3 BCD switching of channel projection - EXT. 1, 2, 3

- for operation see the table
- following this choice the setting for EXT. 2" and "EXT. 3" is automatically restricted

Table with operation of external inputs

Channel	EXT. 1	EXT. 2	EXT. 3
FIL. A	0	0	
FIL. B	0	1	
FIL. C	1	0	
FIL. D	1	1	
MF	0	0	1
Min	0	1	1
Max	1	0	1
Max	1	1	1

STORE Activation of measured data record in instrument memory (not in standard equipment)

- **DEF** EXT. 1 > HOLD
- **DEF** EXT. 2 > LOCK K.
- **DEF** EXT. 3 > SWCH. 1

*

Setting procedure is identical for EXT. 2 and EXT. 3

6.1.4b Selection of function "HOLD"

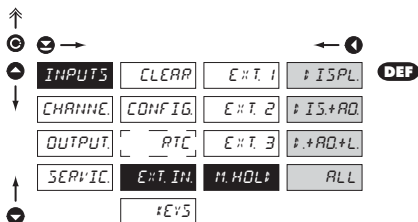

M. HOLD Selection of function "HOLD"

- ISPL.** "HOLD" locks only the value displayed
- IS.+AQ.** "HOLD" locks the value displayed and on AO
- +.AQ.+L.** "HOLD" locks the value displayed, on AO and limit evaluation
- ALL** "HOLD" locks the entire instrument

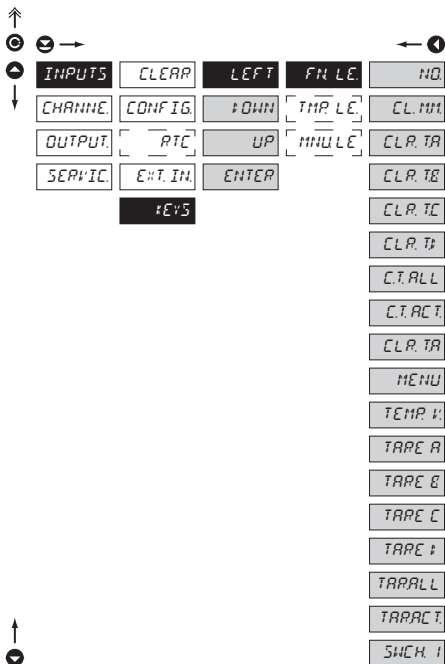
6.1.5a Optional accessory functions of the keys

FN LE Assigning further functions to instrument keys

- „FN. LE.“ > executive functions
- „TMP. LE.“ > temporary projection of selected values
- „MNU. LE.“ > direct access into menu on selected item

NO Key has no further function

CL. MM. Resetting min/max value

CLR. T.- Tare resetting

- TARE A, B, C, D, All, Active

MENU Direct access into menu on selected item

- after confirmation of this selection the "MENU" item is displayed on superior menu level, where required selection is performed

TEMP. V. Temporary projection of selected values

- after confirmation of this selection the item "TEMPOR." is displayed on superior menu level, where required selection is performed

TARE - Tare function activation

- TARE A, B, C, D, All, Active

SWCH. 1 Successive switching of channel projection



Presett values of the keybuttons **DEF**:

LEFT	Channel B, after filtration
UP	Channel C, after filtration
DOWN	Channel D, after filtration
ENTER	Channel switching "SWCH. 1"



Setting is identical for LEFT, DOWN, UP and ENTER



The channel in use is the one permanently displayed

6.1.5b Optional accessory functions of the keys - Temporary projection

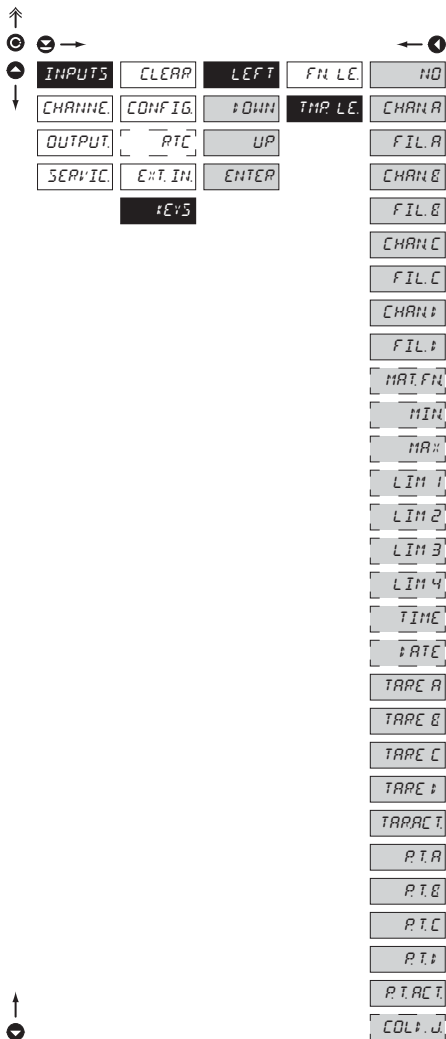

TMP. LE. Temporary projection of selected item

- "Temporary" projection of selected value is displayed for the time of keystroke
- "Temporary" projection may be switched to permanent by pressing **⊕** + "Selected key", this holds until the stroke of any key

- NO** Temporary projection is off
- CHAN. -** Temporary projection of "Channel A, B, C or D" value
- FIL. -** Temporary projection of "Channel A, B, C or D" value after processing digital filters
- MAT. FN.** Temporary projection of "Mathematic functions" value
- MIN** Temporary projection of "Min. value"
- MAX** Temporary projection of "Max. value"
- LIM 1** Temporary projection of "Limit 1" value
- LIM 2** Temporary projection of "Limit 2" value
- LIM 3** Temporary projection of "Limit 3" value
- LIM 4** Temporary projection of "Limit 4" value
- TIME** Temporary projection of "TIME" value
- DATE** Temporary projection of "DATE" value
- TARE -** Temporary projection of "TARE" value
- TARE A, B, C, D, All, Active
- P. T. -** Temporary projection of "P. TARE" value
- TARE A, B, C, D, Active
- COLT. J.** Temporary projection of "CJC" value

! Setting is identical for LEFT, DOWN, UP and ENTER

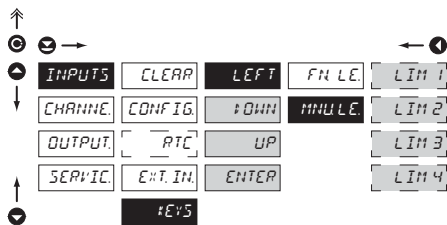
6.1.5c Optional accessory functions of the keys - Direct access to item

MNU LE Assigning access to selected menu item

- LIM 1** Direct access to item "LIM 1"
- LIM 2** Direct access to item "LIM 2"
- LIM 3** Direct access to item "LIM 3"
- LIM 4** Direct access to item "LIM 4"

!
Setting is identical for LEFT, DOWN, UP and ENTER

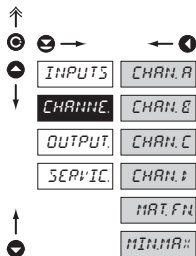
6.2 Setting "PROFI" - CHANNELS



The primary instrument parameters are set in this menu

CHAN. A	Setting parameters of measuring "Channel A"
CHAN. B	Setting parameters of measuring "Channel B"
CHAN. C	Setting parameters of measuring "Channel C"
CHAN. D	Setting parameters of measuring "Channel D"
MAT. FN	Setting parameters of mathematic functions
MIN. MA.	Selection of access and evaluation of Min/max value

6.2.1a Display projection

DC PM DU OHM

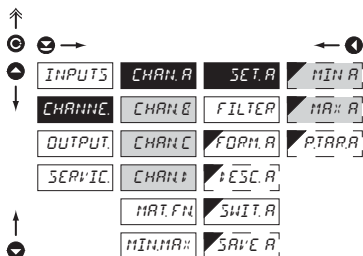

SET. A Setting display projection

MIN. A Setting display projection for minimum value of

input signal

- range of the setting is -99999...999999

- **DEF** = 0

MA. A Setting display projection for maximum value of

input signal

- range of the setting is -99999...999999

- **DEF** = 100

6.2.1b Setting fixed tare

DC PM DU OHM

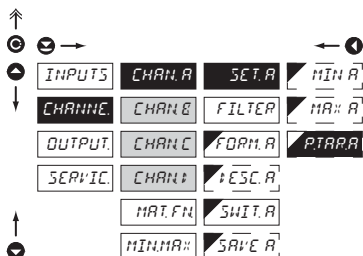

P. TAR. A Setting "Fixed tare" value

- setting is designed for the event when it is necessary to firmly shift the beginning of the range by known size

- when setting (P. TAR. A > 0) display shows "T" symbol

- range of the setting is 0...999999

- **DEF** = 0

6.2.1c Digital filters

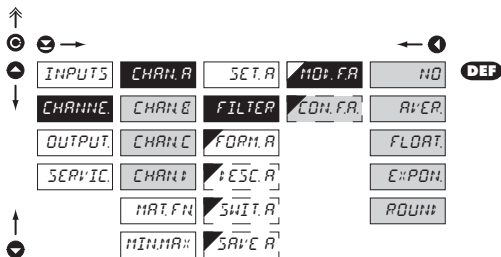

Setting is identical for "Channel B, C and D"

MOD.FA. Selection of digital filters

- at times it is useful for better user projection of data on display to modify it mathematically and properly, wherefore the following filters may be used:

NO Filters are off

AVER. Measured data average

- arithmetic average from given number („CON.F.A.“) of measured values
- range 2...100

FLOAT. Selection of floating filter

- floating arithmetic average from given number („CON.F.A.“) of measured data and updates with each measured value
- range 2...30

EXPON. Selection of exponential filter

- integration filter of first prvního grade with time constant („CON.F.A.“) measurement
- range 2...100

ROUND. Measured value rounding

- is entered by any number, which determines the projection step (e.g: "CON.F.A."=2,5 > display 0, 2.5, 5,...)

CON.F.A. Setting constants

- this menu item is always displayed after selection of particular type of filter

DEF = 2

6.2.1d Projection format - positioning of decimal point

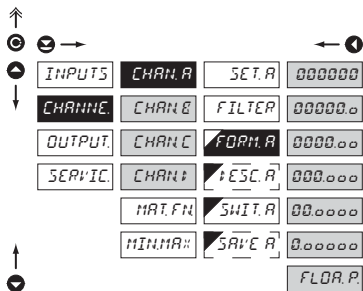

Setting is identical for "Channel B, C and D"

FORM.A Selection of decimal point

- the instrument allows for classic projection of a number with positioning of the DP as well as projection with floating DP, allowing to display a number in its most exact form „FLOA.P.“

000000 Setting DP - XXXXX.

00000.0 Setting DP - XXXXX.x

- **DEF** > **RTD** **T/C**

0000.00 Setting DP - XXXX.xx

- **DEF** > **DC** **PM** **DU** **OHM**

000.000 Setting DP - XXX.xxx

00.0000 Setting DP - XX.xxxx

0.00000 Setting DP - X.xxxxx

FLOA.P Floating DP

6.2.1e Projection of description - the measuring units

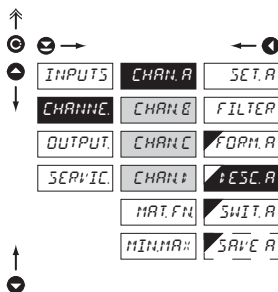

Setting is identical for "Channel B, C and D"

ESC.A Setting projection of description for "Channel A"

- projection of measured data may be extended (at the expense of the number of displayed places) by two characters for description
- description is set by shifted ASCII code, when two first places show the set description and two last characters their code in period 0...95
- description is cancelled by code 00
- **RTD** **T/C** **DEF** = °C
- **DC** **PM** **DU** **OHM** **DEF** = none



Table of signs on page 95

6.2.1f Selection of channel projection upon swithing

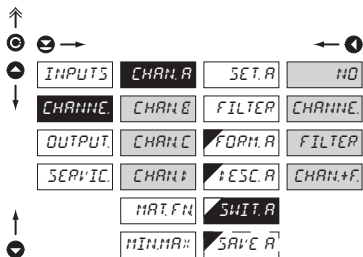

Setting is identical for "Channel B, C and D"

SWIT. A Selection of channel projection upon switching

- setting in this item enables the user to select individual measuring channels which will be displayed upon switching the channel functions „SWIT. A“

- NO Projection restricted
- CHANNEL "Channel A" will be displayed
- FILTER "Channel A" after modification by digital filter
- CHAN. + F. Will be displayed "Channel A" and subsequently also "Channel A" after modification by digital filter A

6.2.1g Selection of storing data into instrument memory

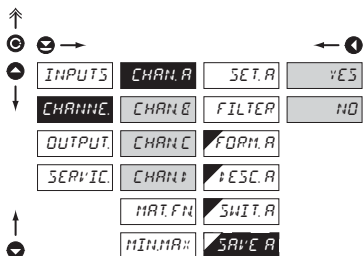

Setting is identical for "Channel B, C and D"

SAVE A Selection of storing data into instrument memory

- by selection in this item you allow to register values into instrument memory
 - another setting in item "OUTPUT. > MEMORY" (not in standard experiment)

- YES Measured data are stored in the memory
- NO Measured data are not stored

6.2.2a Mathematics - input selection

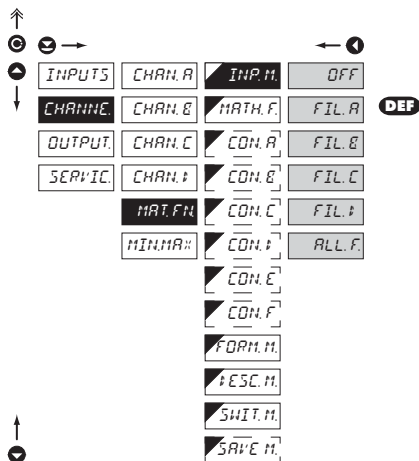
INP. M. Selection of input for calculation of mathematic function

- selection of value from which the mathematic function will be calculated

OFF Mathematic functions are off

FIL. A From "Channel A" after modification by digital filter

FIL. B From "Channel B" after modification by digital filter

FIL. C From "Channel C" after modification by digital filter

FIL. D From "Channel D" after modification by digital filter

ALL. F. From "Channels A, B, C, D" after modification by digital filters

6.2.2b Mathematic functions

↑	⊙	☺	→		←	⓪
↑	INPUTS	CHAN:A	INP:M	OFF	DEF	
↓	CHANNE	CHAN:B	MATH:F	POLIN		
	OUTPUT	CHAN:C	CON:A	1/MUL		
	SEPV:IC	CHAN:D	CON:B	LOGAR		
		MATH:F	CON:C	E:POH		
	MIN:MA	CON:D	POWER			
		CON:E	ROOT			
		CON:F	SIN :			
		FORM:M				
		ESC:M	SUM	DEF		
		SWIT:M	I:I:I:E			
↑		SAV:E:M	QUA:R			
⓪						

MATH.F. Selection of mathematic functions

On selecting „FIL. -“ in item „INP. M.“

OFF Mathematic functions are off

POLIN Polynomial

$$Ax^2 + Bx^4 + Cx^3 + Dx^2 + Ex + F$$

1/MUL $1/x$

$$\frac{A}{x^2} + \frac{B}{x^4} + \frac{C}{x^3} + \frac{D}{x^2} + \frac{E}{x} + F$$

LOGAR Logarithm

$$A \times \ln\left(\frac{Bx+C}{Dx+E}\right) + F$$

E:POH Exponential

$$A \times e^{\left(\frac{Bx+C}{Dx+E}\right)} + F$$

POWER Power

$$A \times (Bx+C)^{(Dx+E)} + F$$

ROOT Root

$$A \times \sqrt{\frac{Bx+C}{Dx+E}} + F$$

SIN : Sin x

$$A \sin^2 x + B \sin^4 x + C \sin^3 x + D \sin^2 x + E \sin x + F$$

On selecting „ALL. F.“ in item „INP. M.“

SUM Sum of the values from channels (inputs)
 $(A \times KA + B \times KB + C \times KC + D \times KD) \times E + F$

I:I:I:E Quotient of values from channels (inputs)
 $(A \times KA + C \times KC) / (B \times KB + D \times KD) \times E + F$

QUA:R Square of values from channels (inputs)
 $(A \times KA^2 + B \times KB^2 + C \times KC^2 + D \times KD^2) \times E + F$

CON. - Setting constants for calculation of mat.

functions

- this menu is displayed only after selection of given mathematic function

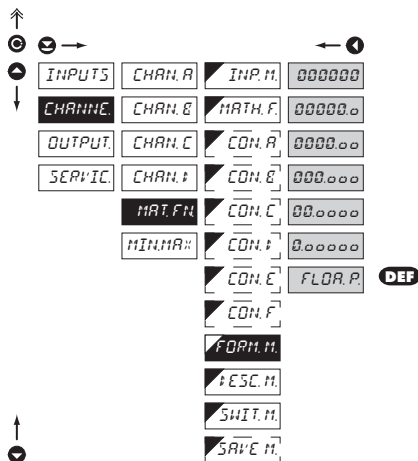
6.2.2c **Mathematic functions - decimal point****FORM.M.** Selection of decimal point

- the instrument allows for classic projection of a number with positioning of the DP as well as projection with floating DP, allowing to display a number in its most exact form „FLOA.P.“

000000 Setting DP - XXXXX.

00000.0 Setting DP - XXXX.x

0000.00 Setting DP - XXXX.xx

000.000 Setting DP - XXX.xxx

00.0000 Setting DP - XX.xxxx

0.00000 Setting DP - X.xxxxx

FLOA.P. Floating DP

DEF

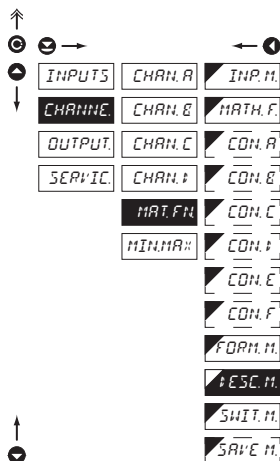
6.2.2d **Mathematic functions - measuring units****↑ESC.M.** Setting projection of description for "MAT.FN"

- projection of measured data may be extended (at the expense of the number of displayed places) by two characters for description
- description is set by shifted ASCII code, when two first places show the set description and two last characters their code in period 0...95
- description is cancelled by code 00

DEF = no description

!
Table of signs on page 95

6.2.2e Mathematics - selection of channel projection upon switching

INPUTS	CHAN. A	INP. M.	YES
CHANNEL	CHAN. B	MATH. F.	NO
OUTPUT	CHAN. C	CON. A	
SERVIC.	CHAN. D	CON. B	
	MAT. FN	CON. C	
	MIN.MA#	CON. D	
		CON. E	
		CON. F	
		FORM. M.	
		ESC. M.	
		SWIT. M.	
		SAVE M.	

SWIT. M. Selection of channel projection upon switching

- setting in this item enables the user to select individual measuring channels which will be displayed upon switching the channel functions „SWIT. A“

- YES Projection permitted
- NO Projection restricted

6.2.2f Mathematics - selection of storing data into instrument memory

INPUTS	CHAN. A	INP. M.	YES
CHANNEL	CHAN. B	MATH. F.	NO
OUTPUT	CHAN. C	CON. A	
SERVIC.	CHAN. D	CON. B	
	MAT. FN	CON. C	
	MIN.MA#	CON. D	
		CON. E	
		CON. F	
		FORM. M.	
		ESC. M.	
		SWIT. M.	
		SAVE M.	

SAVE M. Selection of storing data into instrument memory

- by selection in this item you allow to register values into instrument memory

- another setting in item "OUTPUT. > MEMORY" (not in standard experiment)

- YES Measured data are stored in the memory
- NO Measured data are not stored

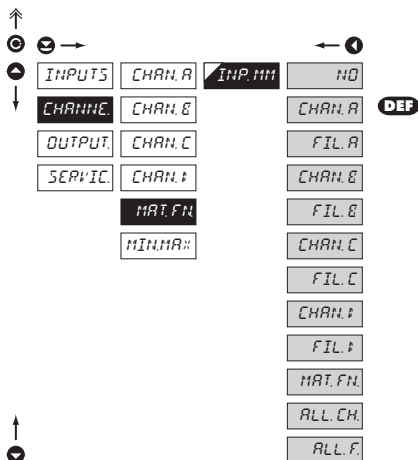
6.2.3 Selection of evaluation of min/max value

INPUTS Selection of evaluation of min/max value

- selection of value from which the min/max value will be calculated

- NO** Evaluation of min/max value is off
- CHAN. A** From "Channel A"
- FIL. A** From "Channel A" after digital filters processing
- CHAN. B** From "Channel B"
- FIL. B** From "Channel B" after digital filters processing
- CHAN. C** From "Channel C"
- FIL. C** From "Channel C" after digital filters processing
- CHAN. D** From "Channel D"
- FIL. D** From "Channel D" after digital filters processing
- MAT. FN** From "Mathematic functions"
- ALL. CH.** From "Channel A, B, C and D"
- ALL. F.** From "Channel A, B, C and D" after digital filters processing

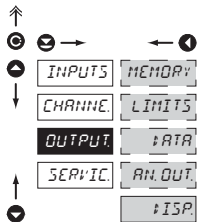
6.3 Setting „PROFI“ - OUTPUTS



In this menu it is possible to set parameters of the instrument output signals

- MEMORY Setting data logging into memory
- LIMITS Setting type and parameters of limits
- DATA Setting type and parameters of data output
- AN. OUT. Setting type and parameters of analog output
- DISP. Setting display projection and brightness

6.3.1a Selection of mode of data logging into instrument memory

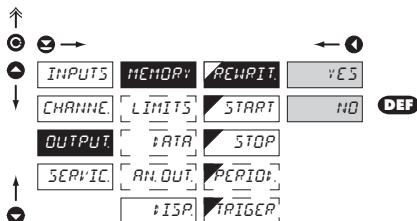

REWRIT. Selection of the mode of data logging

- selection of the mode in the event of full instrument memory

- NO Rewriting values prohibited
- YES Rewriting values permitted, the oldest get rewritten by the latest

6.3.1b Setting data logging into instrument memory - RTC

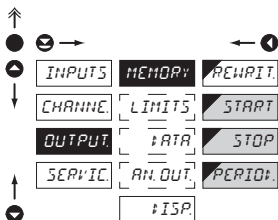

START Start of data logging into instrument memory

- time format HH.MM.SS

STOP Stop data logging into instrument memory

- time format HH.MM.SS

PERIOD+ Period of data logging into instrument memory

- determines the period in which values will be logged in an interval delimited by the time set under items START and STOP

- time format HH.MM.SS

- records are made on a daily basis in selected interval and period

- item not displayed if "STORE" is selected in menu (Input > EXT. IN.)

6.3.1c Setting data logging into instrument memory - FAST

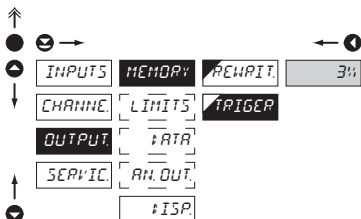

TRIGGER Setting logging data into inst. memory

- logging data into inst. memory is governed by the following selection, which determines how many percent of the memory is reserved for data logging prior to initiation of trigger impulse

- initialization is on ext. input or button

- setting in range 1...100 %

- when setting 100 %, datalogging works in the mode ROLL > data keep getting rewritten in cycles

1. Memory initialization

- clear memory (ext.input, button)

- LED "M" flashes, after reading TRIGGER (%) memory is permanently lit. In ROLL flashes constantly.

2. Triggering

- external input, button

- after the memory LED is full "M" turns off

- in the ROLL mode the trigger ends datalogging and LED turns off

3. Termination

- ext.input, button or reading data via RS

6.3.2a Selection of input for limits evaluation

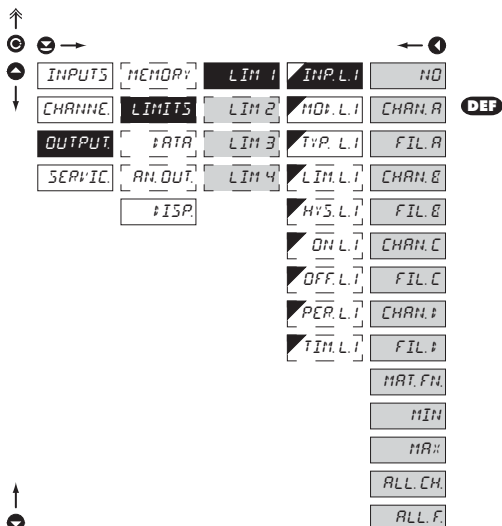
INP. L. 1 Selection evaluation of limits

- selection of value from which the limit will be evaluated

- NO** Limit evaluation is off
- CHAN. A** From "Channel A"
- FIL. A** From "Channel A" after digital filters processing
- CHAN. B** From "Channel B"
- FIL. B** From "Channel B" after digital filters processing
- CHAN. C** From "Channel C"
- FIL. C** From "Channel C" after digital filters processing
- CHAN. D** From "Channel D"
- FIL. D** From "Channel D" after digital filters processing
- MAT. FN.** From "Mathematic functions"
- MIN.** From "Min.value"
- MAX.** From "Max.value"
- ALL. CH.** From "Channel A, B, C and D"
- ALL. F.** From "Channel A, B, C and D" after digital filters processing



Setting is identical for LIM 2, LIM 3 and LIM 4

6.3.2b Selection of type of limit

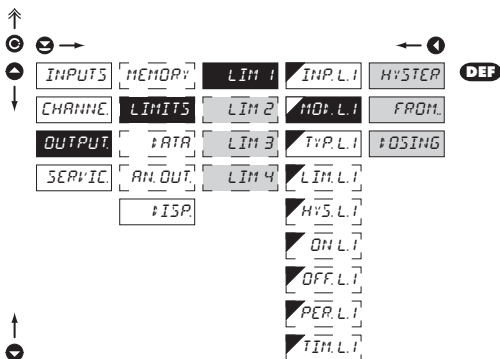

!
Setting is identical for LIM 2, LIM 3 and LIM 4

MOD.L. Selection the type of limit

HYS.TER Limit is in mode "Limit, hysteresis, delay"
- for this mode the parameters of "LIM. L." are set, at which the limit will shall react, "HYS. L." the hysteresis range around the limit (LIM $\pm 1/2$ HYS) and time "TIM. L." determining the delay of relay switch-on

FRON. Frame limit

- for this mode the parameters are set for interval "ON. L." the relay switch-on and "OFF. L." the relay switch-off

POSING Dosing limit (periodic)

- for this mode the parameters are set for "PER. L." determining the limit value as well as its multiples at which the output is active and "TIM. L." indicating the time during which is the output active

6.3.2c Selection of type of output

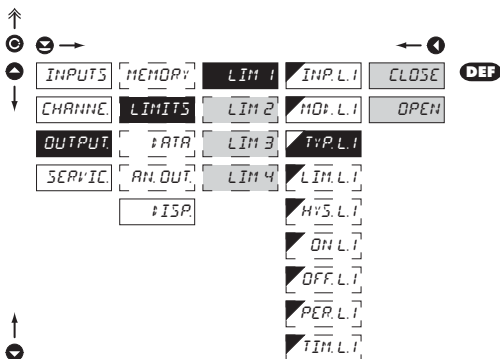

TY.P.L. Selection of type of output

CLOSE Output switches on when condition is met

OPEN Output switches off when condition is met

!
Setting is identical for LIM 2, LIM 3 and LIM 4

6.3.2d Setting values for limits evaluation

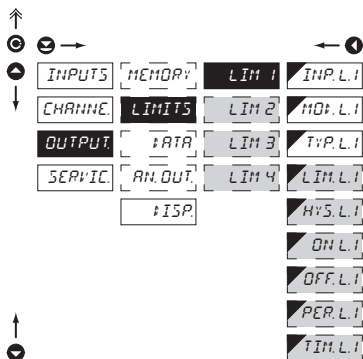

Setting is identical for LIM 2, LIM 3 and LIM 4

- LIM.L1** Setting limit for switch-on
- for type "HYSTER"
- HYS.L1** Setting hysteresis
- for type "HYSTER"
- indicates the range around the limit (in both directions, LIM. $\pm 1/2$ HYS.)
- ON.L1** Setting the outset of the interval of limit switch-on
- for type "FROM.."
- OFF.L1** Setting the end of the interval of limit switch-on
- for type "FROM.."
- PER.L1** Setting the period of limit switch-on
- for type "DOSING"
- TIM.L1** Setting the time switch-on of the limit
- for type "HYSTER" and "DOSING"

6.3.3a Selection of data output baud rate

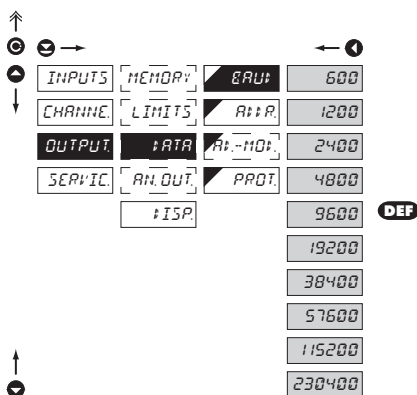

- BAUD** Selection of data output baud rate
- 600** Rate - 600 Baud
- 1200** Rate - 1 200 Baud
- 2400** Rate - 2 400 Baud
- 4800** Rate - 4 800 Baud
- 9600** Rate - 9 600 Baud
- 19200** Rate - 19 200 Baud
- 38400** Rate - 38 400 Baud
- 57600** Rate - 57 600 Baud
- 115200** Rate - 115 200 Baud
- 230400** Rate - 230 400 Baud

6.3.3b Setting instrument address

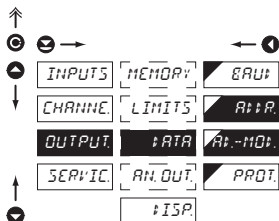

A:R. Setting instrument address

- setting in range 0...31
- **DEF** = 00

A:R. Setting instrument address - MODBUS

- setting in range 1...247
- **DEF** = 1

6.3.3c Selection of data output protocol

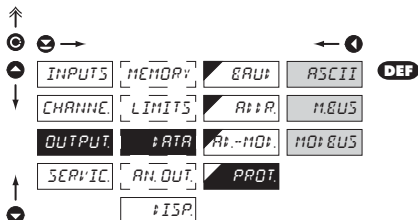

PROT. Selection of the type of analog output

- ASCII** Data protocol ASCII
- M:BUS** Data protocol DIN MessBus
- MOD:BUS** Data protocol MODBUS-RTU
- option is available only for RS 485

6.3.4a Selection of input for analog output

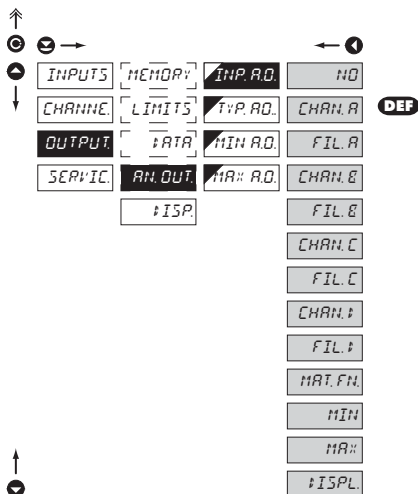
INP. A.D. Selection evaluation analog output

- selection of value from which the analog output will be evaluated

NO	AO evaluation is off
CHAN. A	From "Channel A"
FIL. A	From "Channel A" after digital filters processing
CHAN. B	From "Channel B"
FIL. B	From "Channel B" after digital filters processing
CHAN. C	From "Channel C"
FIL. C	From "Channel C" after digital filters processing
CHAN. D	From "Channel D"
FIL. D	From "Channel D" after digital filters processing
MAT. FN.	From "Math.functions"
MIN	From "Min.value"
MAX	From "Max.value"
±ISPL.	From "Permanently projected display value"

6.3.4b Selection of the type of analog output

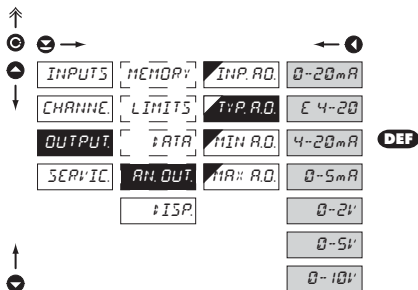

Typ. R.D. Selection of the type of analog output

0-20mA Type - 0...20 mA

4-20 Type - 4...20 mA

- with indication of error statement (< 3,0 mA)

4-20mA Type - 4...20 mA

0-5mA Type - 0...5 mA

0-2V Type - 0...2 V

0-5V Type - 0...5 V

0-10V Type - 0...10 V

6.3.4c Setting the analog output range

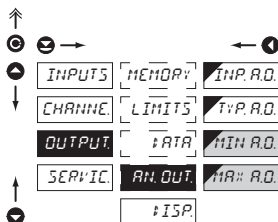

AN. OUT. Setting the analog output range

- analog output is isolated and its value corresponds with displayed data. It is fully programmable, i.e. it allows to assign the AO limit points to two arbitrary points of the entire measuring range

MIN. R.D. Assigning the display value to the beginning of the AO range

- range of the setting is -99999...999999

- **DEF** = 0

MA: R.D. Assigning the display value to the end of the AO range

- range of the setting is -99999...999999

- **DEF** = 100

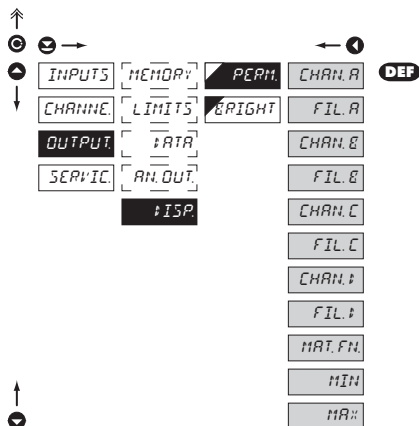
6.3.5a Selection of input for display projection

PERM. Selection display projection

- selection of value which will be shown on the instrument display

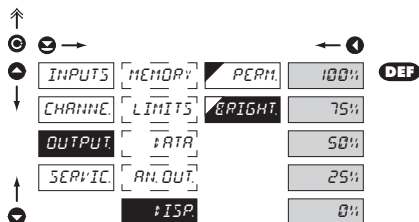
- | | |
|--------|---|
| CHAN.A | From "Channel A" |
| FIL.A | From "Channel A" after digital filters processing |
| CHAN.B | From "Channel B" |
| FIL.B | From "Channel B" after digital filters processing |
| CHAN.C | From "Channel C" |
| FIL.C | From "Channel C" after digital filters processing |
| CHAN.D | From "Channel D" |
| FIL.D | From "Channel D" after digital filters processing |
| MAT.FN | From "Math.functions" |
| MIN | From "Min.value" |
| MAX | From "Max.value" |

6.3.5b Selection of display brightness

BRIGHT. Selection of display brightness

- by selecting display brightness we may appropriately react to light conditions in place of instrument location

- | | |
|------|---------------------------|
| 0% | Display is off |
| 25% | Display brightness - 25% |
| 50% | Display brightness - 50% |
| 75% | Display brightness - 75% |
| 100% | Display brightness - 100% |

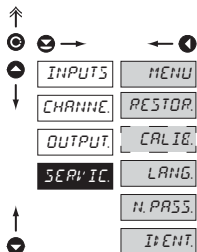
6.4 Setting "PROFI" - SERVIS



The instrument service functions are set in this menu

MENU	Selection of menu type LIGHT/PROFI
RESTOR	Restore instrument manufacture setting and calibration
CALIB	Input range calibration for „DU“ version
LANG	Language version of instrument menu
H.PASS	Setting new access password
IDENT	Instrument identification

6.4.1 Selection of type of programming menu

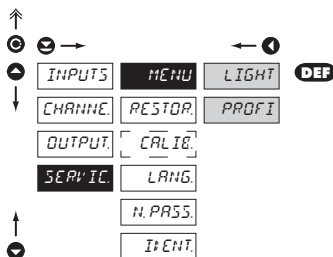

Change of setting is valid upon next access into menu

MENU Selection of menu type - LIGHT/PROFI

- enables setting the menu complexity according to user needs and skills

LIGHT Active LIGHT menu

- simple programming menu, contains only items necessary for configuration and instrument setting
- linear menu > items one after another

PROFI Active PROF I menu

- complete programming menu for expert users
- tree menu

6.4.2 Restoration of manufacture setting

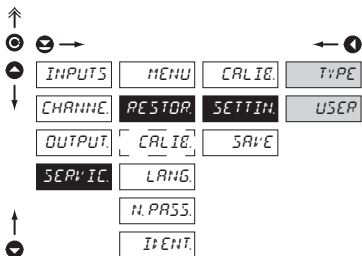
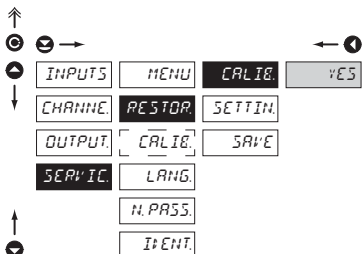

RESTOR Restoration of manufacture setting

- in the event of error setting or calibration, manufacture setting may be restored.

CALIB Restoration of manufacture calibration of the instrument

- prior executing the changes you will be asked to confirm your selection „YES“

SETTIN Restoration of instrument manufacture setting

TYPE Restoration of instrument manufacture setting

- generating the manufacture setting for currently selected type of instrument (items marked DEF)

USER Restoration of instrument user setting

- generating the instrument user setting, i.e. setting stored under SERVIC./RESTOR./SAVE

SAVE Save instrument user setting

- storing the user setting allows the operator to restore it in future if needed

Jobs performed	Restore	
	Calibration	Setting
cancel USER menu rights	✓	✓
deletes table of items order in USER - LIGHT menu	✓	✓
adds items from manufacture to LIGHT menu	✓	✓
deletes data stored in FLASH	✓	✓
cancel or linearization tables	✓	✓
clears tare	✓	✓
clears conduct resistances	✓	✓
restore manufacture calibration	✓	x
restore manufacture setting	x	✓



After restoration the instrument switches off for couple seconds

6.4.3 Calibration - Input range

DU

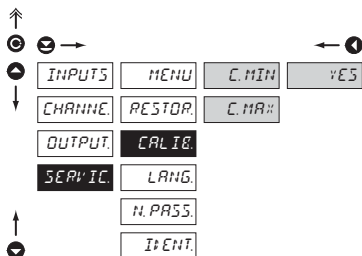
**CALIB.** Input range calibration

- when "C. MIN" is displayed, move the potentiometer traveller to the required minimum position and confirm by „Enter“, calibration is confirmed by "YES"
- when "C. MAX" is displayed, move the potentiometer traveller to required maximum position and confirm by „Enter“, calibration is confirmed by „YES"

6.4.4 Selection of instrument menu language version

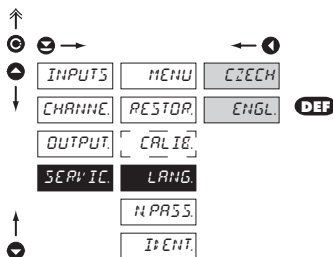
**LANG.** Selection of instrument menu language version

- CZECH** Instrument menu is in Czech
- ENGL.** Instrument menu is in English

6.4.5 Setting new access password

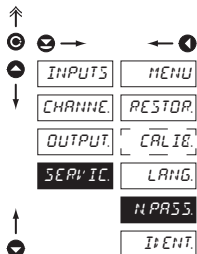
**N. PASS.** Setting new password for access to LIGHT and PROFi menu

- this selection enables changing number code that blocks the access into LIGHT and PROFi Menu.
- range of the number code is 0...9999
- universal password in the event of loss is „8177"

6.4.6 Instrument identification

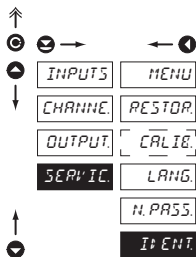

I: ENT. Projection of instrument SW version

- display shows type identification of the instrument, SW number, SW version and current input setting (Mode)
- if the SW version reads a letter on first position, it is a customer SW

7.0 Setting items into "USER" menu

- **USER** menu is designed for users who need to change only several items of the setting without the option to change the primary instrument setting (e.g. repeated change of limit setting)
- there are no items from manufacture permitted in **USER** menu
- on items indicated by inverse triangle  L i
- setting may be performed in **LIGHT** or **PROFI** menu, with the **USER** menu then overtaking the given menu structure



- For user operation
- Menu items are set by the user (Profi/Light) as per request
- Access is not password protected

Setting

flashing legend - current setting is displayed



H0

item will not be displayed in USER menu

YES

item will be displayed in USER menu with editing option

SHOW

item will be solely displayed in USER menu

Setting sequence of items in "USER" menu

In compiling USER menu from active LIGHT menu the items (max. 10) may be assigned a sequence, in which they will be projected in the menu



Example:

Into USER menu were selected these items

(keys +) > TARE A, LIM 1, LIM 2, LIM 3, for which we have preset this sequence (keys +):

TARE A	5
LIM 1	0 (sequence not determined)
LIM 2	2
LIM 3	1

Upon entering USER menu

(key) items will be projected in the following sequence: LIM 3 > LIM 2 > TARE A > LIM 1

Instrument with input for temperature measurement with thermocouple allows to set two types of measurement of cold junction.

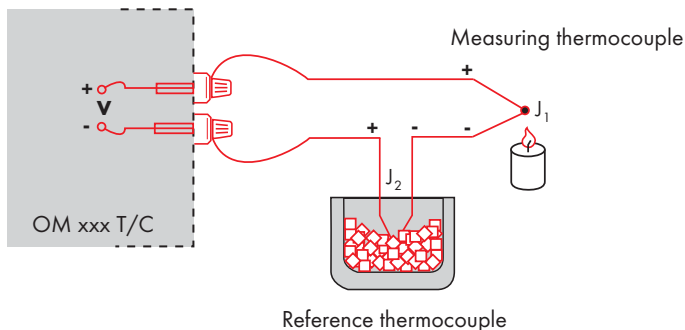

WITH REFERENCE THERMOCOUPLE

- a reference thermocouple may be located in the same place as the measuring instrument or in place with stable temperature/compensation box
- when measuring with reference thermocouple set *CONNECT* in the instrument menu to *INT2TC* or *E#T2TC*
- when using a thermostat (a compensation box or environment with constant temperature) set in the instrument menu *CJCTEM* its temperature (applies for setting *CONNECT* to *E#T2TC*)
- if the reference thermocouple is located in the same environment as the measuring instrument then set in the instrument menu *CONNECT* to *INT2TC*. Based on this selection the measurement of the ambient temperature is performed by a sensor located in the instrument terminal board.

WITHOUT REFERENCE THERMOCOUPLE

- inaccuracy originating from the creation of dissimilar thermocouples on the transition point terminal/conductor of the thermocouple is not compensated for in the instrument
- when measuring without reference thermocouple set *CONNECT* in the instrument menu to *INT1TC* or *E#T1TC*
- when measuring temperature without reference thermocouple the error in measured data may be as much as 10°C (applies for setting *CONNECT* to *E#T1TC*)

The instruments communicate via serial line RS232 or RS485. For communication they use the ASCII protocol. Communication runs in the following format:

ASCII: 8 bit, no parity, one stop bit
 DIN MessBus: 7 bit, even parity, one stop bit

The transfer rate is adjustable in the instrument menu. The instrument address is set in the instrument menu in the range of 0 ÷ 31. The manufacture setting always presets the ASCII protocol, rate of 9600 Baud, address 00. The type of line used - RS232 / RS485 - is determined by an output board automatically identified by the instrument.

The commands are described in specification you can find at www.orbit.merret.cz/rs.

DETAILED DESCRIPTION OF COMMUNICATION VIA SERIAL LINE

Activity	Data transferred										
Data solicitation (PC)	#	A	A	<CR>							
Data transmission (Instrument)	>	R	<SP>	D	D	D	D	D	(D)	(D)	<CR>
Command confirm. (Instr.) - OK	!	A	A	<CR>							
Command confirm. (Instr.) - Bad	?	A	A	<CR>							
Instrument identification	#	A	A	1Y	<CR>						
HW identification	#	A	A	1Z	<CR>						
One-time measurement	#	A	A	7X	<CR>						
Repeated measurement	#	A	A	8X	<CR>						

LEGEND

#	35	23 _H	Command beginning
A	A	0...31	Two signs of instrument address (sent in ASCII - tens and ones, e.g. "01", "99" universal
<CR>	13	0D _H	Carriage return
<SP>	32	20 _H	Space
D			Data - usually signs "0"... "9", ".", "-", ";", (D) - DP. and (-) may prolong data
R	50 _H ...57 _H		Relay and Tare status
!	33	21 _H	Positive command confirmation (ok)
?	63	3F _H	Negative command confirmation (bad)
>	62	3E _H	Beginning of the data transmitted

RELAY, TARE

Sign	Relay 1	Relay 2	Tare	Change relay 3/4
P	0	0	0	0
Q	1	0	0	0
R	0	1	0	0
S	1	1	0	0
T	0	0	1	0
U	1	0	1	0
V	0	1	1	0
W	1	1	1	0
p	0	0	0	1
q	1	0	0	1
r	0	1	0	1
s	1	1	0	1
t	0	0	1	1
u	1	0	1	1
v	0	1	1	1
w	1	1	1	1

ERROR	CAUSE	ELIMINATION
<i>E. I. U_n</i>	Number is too small (large negative) to be displayed	change DP setting, channel constant setting
<i>E. I. O_r</i>	Number is too large to be displayed	change DP setting, channel constant setting
<i>E. T. U_n</i>	Number is outside the table range	increase table values, change input setting (channel constant setting)
<i>E. T. O_r</i>	Number is outside the table range	increase table values, change input setting (channel constant setting)
<i>E. I. U_n</i>	Input quantity is smaller than permitted input quantity range	change input signal value or input (range) setting
<i>E. I. O_r</i>	Input quantity is larger than permitted input quantity range	change input signal value or input (range) setting
<i>E. HH</i>	A part of the instrument does not work properly	send the instrument for repair
<i>E. EE</i>	Data in EEPROM corrupted	perform restoration of manufacture setting, upon repeated error statement send instrument for repair
<i>E. I. ATA</i>	Data in EEPROM outside the range	perform restoration of manufacture setting, upon repeated error statement send instrument for repair
<i>E. CLR</i>	Memory was empty (presetting carried out)	upon repeated error statement send instrument for repair, possible failure in calibration

The instrument allows to add two descriptive characters to the classic numeric formats (at the expense of the number of displayed places). The setting is performed by means of a shifted ASCII code. Upon modification the first two places display the entered characters and the last two places the code of the relevant symbol from 0 to 95. Numeric value of given character equals the sum of the numbers on both axes of the table.

Description is cancelled by entering characters with code 00

	0	1	2	3	4	5	6	7		0	1	2	3	4	5	6	7	
0		7	"	#	\$	%	&	'		0	!	"	#	\$	%	&	'	
8	:)	*	+	,	-	.	/		8	()	*	+	,	-	.	/
16	0	1	2	3	4	5	6	7		16	0	1	2	3	4	5	6	7
24	8	9	:	;	<	=	>	?		24	8	9	:	;	<	=	>	?
32	P	R	E	C	T	E	F	G		32	@	A	B	C	D	E	F	G
40	H	I	J	K	L	M	N	O		40	H	I	J	K	L	M	N	O
48	P	Q	R	S	T	U	V	W		48	P	Q	R	S	T	U	V	W
56	X	Y	Z	[\]	^	_		56	X	Y	Z	[\]	^	_
64	`	a	b	c	d	e	f	g		64	`	a	b	c	d	e	f	g
72	h	i	j	k	l	m	n	o		72	h	i	j	k	l	m	n	o
80	p	q	r	s	t	u	v	w		80	p	q	r	s	t	u	v	w
88	x	y	z	{		}	~		88	x	y	z	{		}	~		

INPUT - CHANNEL A

range is adjustable

±60 mV	>100 MOhm
±150 mV	>100 MOhm
±300 mV	>100 MOhm
±1200 mV	>100 MOhm

DC

Input U
Input U
Input U
Input U

range is adjustable

0/4...20 mA	< 400 mV
±2 V	1 MOhm
±5 V	1 MOhm
±10 V	1 MOhm
±40 V	1 MOhm

PM

Input I
Input U
Input U
Input U
Input U

range is adjustable

0...100 Ohm
0...1 kOhm
0...10 kOhm
0...100 kOhm

OHM

Connection:

2, 3 or 4 wire

Pt xxxx

-200°...850°C

Pt xxxx/3910 ppm

-200°...1 100°C

Ni xxxx

-50°...250°C

Cu/4260 ppm

-50°...200°C

Cu/4280 ppm

-200°...200°C

Type Pt:

EU > 100/500/1 000 Ohm, with 3 850 ppm/°C

US > 100 Ohm, with 3 920 ppm/°C

RU > 50/100 Ohm, with 3 910 ppm/°C

Type Ni:

Ni 1 000/ Ni 10 000 with 5 000/6 180 ppm/°C

Type Cu:

Cu 50/Cu 100 with 4 260/4 280 ppm/°C

Connection:

2, 3 or 4 wire

RTD

range is adjustable in configuration menu

Type:

J (Fe-CuNi) -200°...900°C

K (NiCr-Ni) -200°...1 300°C

T (Cu-CuNi) -200°...400°C

E (NiCr-CuNi) -200°...690°C

B (PtRh30-PtRh6) 300°...1 820°C

S (PtRh10-Pt) -50°...1 760°C

R (Pt13Rh-Pt) -50°...1 740°C

N (Omegalloy) -200°...1 300°C

L (Fe-CuNi) -200°...900°C

T/C

Voltage of lin. pot.

2,5 VDC/6 mA

min. potentiometer resistance is 500 Ohm

DU**INPUT - CHANNEL B**

range is adjustable

0/4...20 mA	< 400 mV
±2 V	1 MOhm
±5 V	1 MOhm

PM

Input I
Input U
Input U

±10 V

1 MOhm

Input U

±40 V

1 MOhm

Input U

INPUT - CHANNEL C

range is adjustable

0/4...20 mA	< 400 mV
±2 V	1 MOhm
±5 V	1 MOhm
±10 V	1 MOhm
±40 V	1 MOhm

PM

Input I
Input U
Input U
Input U
Input U

INPUT - CHANNEL D

range is adjustable

0/4...20 mA	< 400 mV
±2 V	1 MOhm
±5 V	1 MOhm
±10 V	1 MOhm
±40 V	1 MOhm

PM

Input I
Input U
Input U
Input U
Input U

PROJECTION

Display:

999999, intensive red or green
14-ti segment LED, digit height 14 mm

Projection:

±9999 (99999...999999)

Decimal point:

adjustable - in menu

Brightness:

adjustable - in menu

INSTRUMENT ACCURACY

TC:

100 ppm/°C

Accuracy:

±0,1 % of range + 1 digit

±0,15 % of range + 1 digit

RTD, T/C**Above accuracies apply for projection 9999**

Resolution:

0,01°/0,1°/1°

RTD

Rate:

0,1...40 measurements/s, see table

Overload capacity:

10x (t < 100 ms) not for 400 V and 5 A,
2x (long-term)

Linearisation:

by linear interpolation in 50 points
- solely via OM Link

Digital filters:

Averaging, Floating average, Exponential filter, Rounding

Comp. of conduct:

max. 40 Ohm/100 Ohm

RTD

Comp. of cold junct.:

adjustable

T/C

0°...99°C or automatic

Functions:

Tare - display resetting
Hold - stop measuring (at contact)
Lock - control key locking
MM - min/max value

Mathematic functions

OM Link:

company communication interface for setting, operation
and update of instrument SW

Watch-dog:

reset after 400 ms

Calibration:

at 25°C and 40 % of r.h.

* values apply for resistance load

COMPARATOR

Type: digital, adjustable in menu
 Mode: Hysteresis, From, Dose
 Limita: -99999...999999
 Hysteresis: 0...999999
 Delay: 0...99,9 s
 Outputs: 2x relays with switch-on contact (Form A)
 (230 VAC/30 VDC, 3 A)*
 2x relays with switch-off contact (Form C)
 (230 VAC/50 VDC, 3 A)*
 2x SSR (250 VAC/ 1 A)*
 2x/4x open collector (30 VDC/100 mA)
 2x bistabil relays (250 VAC/250 VDC, 3 A/0,3 A)*
 Relay: 1/8 HP 277 VAC, 1/10 HP 125 V, Pilot Duty D300

DATA OUTPUTS

Protocols: ASCII, DIN MessBus
 Data format: 8 bit + no parity + 1 stop bit (ASCII)
 7 bit + even parity + 1 stop bit (MessBus)
 Rate: 600...230 400 Baud
 RS 232: isolated, two-way communication
 RS 485: isolated, two-way communication,
 addressing (max. 31 instruments)
 PROFIBUS Data protocol SIEMENS

ANALOGO OUTPUTS

Type: isolated, programmable with resolution of max.10 000 points, analog output corresponds with displayed data, type and range are adjustable
 Non-linearity: 0,2 % of range
 TC: 100 ppm/°C
 Rate: response to change of value < 40 ms
 Voltage: 0...2 V/5 V/10 V
 Current: 0...5/20 mA/4...20 mA
 - compensation of conduct to 500 Ohm/12 V
 or 1 000 Ohm/24 V

MEASURED DATA RECORD

Type RTC: time-controlled logging of measured data into instrument memory, allows to log up to 250 000 values
 Type FAST: fast data logging into instrument memory, allows to log up to 8 000 values at a rate of 40 records/s
 Transmission: via data output RS 232/485 or via OM Link

EXCITATION

Adjustable: 5...24 VDC/max. 1,2 W, isolated

POWER SUPPLY

Options: 10...30 V AC/DC, 10 VA, isolated,
 - fuse inside (T 4000 mA)
 80...250 V AC/DC, 10 VA, isolated
 - fuse inside (T 630 mA)

MECHANIC PROPERTIES

Material: Noryl GFN2 SE1, incombustible UL 94 V-I
 Dimensions: 96 x 48 x 120 mm
 Panel cut-out: 90,5 x 45 mm

OPERATING CONDITIONS

Connection: connector terminal board,
 conductor cross-section <1,5 mm² /<2,5 mm²
 Stabilisation period: within 15 minutes after switch-on
 Working temp.: 0°...60°C
 Storage temp.: -10°...85°C
 Cover: IP65 (front panel only)
 Construction: safety class I
 Overvoltage category: EN 61010-1, A2
 Insulation resistance: for pollution degree II, measurement category III
 instrum.power supply > 670 V (PI), 300 V (DI)
 Input/output > 300 V (PI), 150 (DI)
 EMC: EN 61000-3-2+A12; EN 61000-4-2, 3, 4, 5, 8, 11;
 EN 550222, A1, A2

Table of mesuring rate depending on the number of inputs

Channels/Rate	40	20	10	5	2	1	0,5	0,2	0,1
Qty. of channels: 1 (Type: DC, PM, DU)	40,00	20,00	10,00	5,00	2,00	1,00	0,50	0,20	0,10
Qty. of channels: 2	5,00	2,50	1,25	1,00	0,62	0,38	0,22	0,09	0,05
Qty. of channels: 3	3,33	1,66	0,83	0,66	0,42	0,26	0,14	0,06	0,03
Qty. of channels: 4	2,50	1,25	0,62	0,50	0,31	0,19	0,11	0,05	0,02
Qty. of channels: 1 (Type: OHM, RTD, T/C)	5,00	2,50	1,25	1,00	0,62	0,38	0,22	0,09	0,05
Qty. of channels: 2	3,33	1,066	0,83	0,66	0,42	0,26	0,14	0,06	0,03
Qty. of channels: 3	2,50	1,25	0,62	0,50	0,31	0,19	0,11	0,05	0,02
Qty. of channels: 4	2,00	1,00	0,50	0,40	0,25	0,15	0,08	0,04	0,02

PI - Primary insulation, DI - Double insulation

Front view



Panel cut

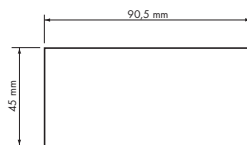

Side view

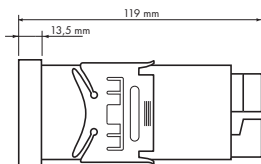

Panel thickness: 0,5...20 mm

Instrument installation

1. insert the instrument into the panel cut-out
2. fit both travellers on the box
3. press the travellers close to the panel

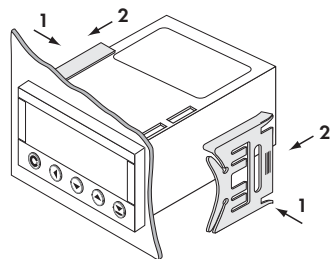
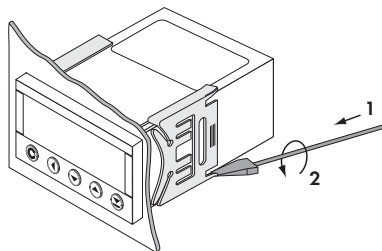

Instrument disassembly

1. slide a screw driver under the traveller wing
2. turn the screw driver and remove the traveller
3. take the instrument out of the panel

Product **OM 402UNI B**
 Type
 Manufacturing No.
 Date of sale

GUARANTEE

A guarantee period of 60 months from the date of sale to the user applies to this instrument.
 Defects occurring during this period due to manufacture error or due to material faults shall be eliminated free of charge.

For quality, function and construction of the instrument the guarantee shall apply provided that the instrument was connected and used in compliance with the instructions for use.

The guarantee shall not apply to defects caused by:

- mechanic damage
- transportation
- intervention of unqualified person incl. the user
- unavoidable event
- other unprofessional interventions

The manufacturer performs guarantee and post.guarantee repairs unless provided for otherwise.

YEARS

Stamp, signature

DECLARATION OF CONFORMITY

Company: **ORBIT MERRET, spol. s r.o.**
Klánska 81/141, 142 00 Prague 4, Czech Republic, IDNo: 00551309

Manufactured: **ORBIT MERRET, spol. s r.o.**
Vodňanská 675/30, 198 00 Prague 9, Czech Republic

declares at its full responsibility that the product presented hereunder meets all technical requirements, is safe for use when utilised under the terms and conditions determined by ORBIT MERRET, spol.s r.o. and that our company has taken all measures to ensure conformity of all products of the type listed hereunder, which are being brought out to the market, with technical documentation and requirements of the appurtenant statutory orders.

Product: 4-digit programmable panel instrument

Type: **OM 402**

Version: UNI, PWR

Conformity is assessed pursuant to the following standards:

El. safety:	EN 61010-1
EMC:	EN 50131-1, chapter 14 and chapter 15
	EN 50130-4, chapter 7
	EN 50130-4, chapter 8
	EN 50130-4, chapter 9
	EN 50130-4, chapter 10
	EN 50130-4, chapter 11
	EN 50130-4, chapter 12
	EN 50130-4, chapter 13
	EN 50130-5, chapter 20
	prEN 50131-2-1, par. 9.3.1
	EN 61000-4-8
	EN 61000-4-9
	EN 61000-3-2 ed. 2:2001
	EN 61000-3-3: 1997, Cor. 1:1998, Z1:2002
	EN 55022, chapter 5 and chapter 6

and Ordinance on:

El. safety:	No. 168/1997 Coll.
EMC:	No. 169/1997 Coll.

The evidence are the protocols of authorized and accredited organizations:

VTÚE Praha, experimental laboratory No. 1158, accredited by ČIA
VTÚPV Vyškov, experimental laboratory No. 1103, accredited by ČIA

Place and date of issue: Prague, 18. March 2006

Miroslav Hackl v.r.
Company representative

Mode of asses. of conformity §12, par. 4 b, d Act No. 22/1997 Coll.