

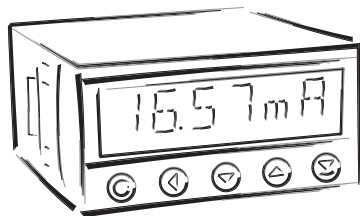

OM 502

5 DIGIT PROGRAMMABLE INSTRUMENT

DC VOLTMETER/AMMETER
PROCESS MONITOR
INTEGRATOR
LINEARIZATOR
DISPLAYS FOR LINEAR POTENTIOMETERS
DISPLAY INSTRUMENT FOR TENSIDMETER





SAFETY INSTRUCTIONS

Please, read the enclosed safety instructions carefully and observe them!
These instruments should be safeguarded by isolated or common fuses (breakers)!
For safety information the EN 61 010-1 + A2 standard must be observed.
This instrument is not explosion-safe!

TECHNICAL DATA

Measuring instruments of the OM 502 series conform to the European regulation no. 73/23/EHS and no. 2004/108/EHS

The instruments are up to the following European standards:
EN 61010-1, Electric safety
EN 61326-1, Electronic measuring, control and laboratory devices – Requirements for EMC "Industrial use"

The instruments are applicable for unlimited use in agricultural and industrial areas.

CONNECTION

Supply of energy from the main line has to be isolated from the measuring leads.

ORBIT MERRET, spol. s r.o.

Vodnanska 675/30
198 00 Prague 9
Czech Republic

Tel: +420 - 281 040 200
Fax: +420 - 281 040 299
e-mail: orbit@merret.cz
www.orbit.merret.cz



1. CONTENTS	3
2. INSTRUMENT DESCRIPTION	4
3. INSTRUMENT CONNECTION	6
Measuring ranges	6
Termination of RS 485 communication line	6
Instrument connection	7
Recommended connection of sensors	8
4. INSTRUMENT SETTING	10
Symbols used in the instructions	12
Setting the DP and the (-) sign	12
Control keys function	13
Setting/permitting items into "USER" menu	13
5. SETTING "LIGHT" MENU	14
5.0 Description "LIGHT" menu	14
Setting input - Type "DC"	18
Setting input - Type "PM"	20
Setting input - Type "I"	22
Setting input - Type "LX"	24
Setting input - Type "DU"	26
Setting input - Type "T"	28
Setting Limits	30
Setting analog output	32
Selection of programming menu „LIGHT"/„PROFI"	34
Restoration of manufacture setting	34
Automatic calibration - input range (only "DU")	35
Selection of instrument menu language version	36
Setting new access password	36
Instrument identification	37
6. SETTING "PROFI" MENU	38
6.0 Description of "PROFI" menu	38
6.1 "PROFI" menu - INPUTS	
6.1.1 Resetting internal values	40
6.1.2 Setting measuring type, range, mode, rate ..	41
6.1.3 Setting the Real Time	43
6.1.4 External input function selection	46
6.1.5 Optional accessory functions of the keys ..	47
6.2 "PROFI" menu - CHANNEL	
6.2.1 Setting measuring parameters (projection, filters, decimal point, description)	50
6.2.2 Setting mathematic functions	55
6.2.3 Setting integrator parameters	58
6.2.4 Selection of evaluation of min/max. value ..	62
6.3 "PROFI" menu - OUTPUT	
6.3.1 Setting data logging	64
6.3.2 Setting Limits	66
6.3.3 Setting data output	69
6.3.4 Setting analog output	70
6.3.5 Selection of display projection	72
6.4 "PROFI" menu - SERVICE	
6.4.1 Selection of programming menu „LIGHT"/„PROFI"	74
6.4.2 Restoration manufacture setting	75
6.4.3 Automatic calibration - input range	76
6.4.4 Selection of instrument menu language version	77
6.4.5 Setting new access password	77
6.4.6 Instrument identification	77
7. SETTING ITEMS INTO "USER" MENU	78
7.0 Configuration "USER" menu	78
8. DATA PROTOCOL	80
9. ERROR STATEMENTS	82
10. TABLE OF SYMBOLS	83
11. TECHNICAL DATA	84
12. INSTRUMENT DIMENSIONS AND INSTALLATION	86
13. CERTIFICATE OF GUARANTEE	87

2. INSTRUMENT DESCRIPTION



2.1 DESCRIPTION

The OM 502 model series are 5 digit panel programmable instruments.

The instrument is based on 8-bit microcontroller with high-rate 24-bit sigma-delta converter, which secures high accuracy, stability and easy operation of the instrument.

TYPES AND RANGES

DC	DC Voltmeter/Ammeter ±999,99 mV; ±999,99 mV; ±9,9999 V; ±99,999 V; ±300,00 V ±999,99 A; ±9,9999 mA; ±99,999 mA; ±999,99 mA; ±5,0000 A
PM	Process monitor 0...5 mA/0...20 mA/4...20 mA/±2 V/±5 V/±10 V
I	Integrator 0...5 mA/0...20 mA/4...20 mA/±2 V/±5 V/±10 V
L	Linearizator 0...5 mA/0...20 mA/4...20 mA/±2 V/±5 V/±10 V
DU	Display unit for linear potentiometers Linear potentiometer [min. 500 Ω]
T	Weighing indicator 1..4 mV/V; 2..8 mV/V; 4..16 mV/V

PROGRAMMABLE PROJECTION, FUNCTION

Measuring range:	adjustable (PM, I, LX) or as per order (DC, T)
Setting:	manual, optional display projection may be set for both limit values of the input signal, e.g. input 0...20 mA > 0...8500,0
Projection:	±99999 (-99999...999999)
Integration (I):	with time base 1 s, projection of integrated and current value
Weighing function (T):	manual or automatic calibration, signalization of stabilized equilibrium, zero stabilization, automatic zero monitoring, defined number of sections on the scale
Projection (T):	±99999 (Mode - Standard) selection of size of the section - 0,001/0,002/0,005/0,01/0,02/0,05/0,1/0,2/0,5/1/2/5/ 10/20/50/100 (Mode - WEIGHT)

LINEARIZATION

Linearization:	by linear interpolation in 50 points (solely via OM Link)
Linearization (LX):	linear interpolation in 256 points and 16 tables

DIGITAL FILTERS

Floating average:	from 2...30 measurements
Exponen.average:	from 2...100 measurements
Rounding:	setting the projection step for display

MATHEMATIC FUCTIONS

Min/max. value:	registration of min./max. value reached during measurement
Tare:	designed to reset display upon non-zero input signal
Fixed tare:	fixed preset tare
Peak value:	the display shows only max. or min. value
Mat. operations:	polynome, 1/x, logarithm, exponential, power, root, sin x

EXTERNAL CONTROL

Lock:	control keys blocking
Hold:	display/instrument blocking
Tare:	tare activation/resetting tare to zero
Resetting MM:	resetting min/max value
Memory:	data storage into instrument memory

2.2 OPERATION

The instrument is set and controlled by five control keys located on the front panel. All programmable settings of the instrument are performed in three adjusting modes:

LIGHT	Simple programming menu - contains solely items necessary for instrument setting and is protected by optional number code
PROFI	Complete programming menu - contains complete instrument menu and is protected by optional number code
USER	User programming menu - may contain arbitrary items selected from the programming menu (LIGHT/PROFI), which determine the right [see or change] - access without password

All programmable parameters are stored in the EEPROM memory (they hold even after the instrument is switched off).

OMLINK Complete instrument operation and setting may be performed via OM Link communication interface, which is a standard equipment of all instruments.

The operation program is freely accessible (www.orbit.merret.cz) and the only requirement is the purchase of OML cable to connect the instrument to PC. It is manufactured in version RS 232 and USB and is compatible with all ORBIT MERRET instruments. Another option for connection is with the aid of data output RS 232 or RS 485 (without the need of the OML cable).

The program OM LINK in „Basic“ version will enable you to connect one instrument with the option of visualization and archiving in PC. The OM Link „Standard“ version has no limitation of the number of instruments connected.

2.3 OPTIONS

Excitation is suitable for supplying power to sensors and transmitters. It has a galvanic separation.

Comparators are assigned to monitor one, two, three or four limit values with relay output. The user may select limits regime: LIMIT/DOSING/FRDM-TD. The limits have adjustable hysteresis within the full range of the display as well as selectable delay of the switch-on in the range of 0...99,9 s. Reaching the preset limits is signalled by LED and simultaneously by the switch-on of the relevant relay.

Data outputs are for their rate and accuracy suitable for transmission of the measured data for further projection or directly into the control systems. We offer an isolated RS232 and RS485 with the ASCII, MESSBUS, MODBUS - RTU or PROFIBUS protocol.

Analog outputs will find their place in applications where further evaluating or processing of measured data is required in external devices. We offer universal analog output with the option of selection of the type of output - voltage/current. The value of analog output corresponds with the displayed data and its type and range are selectable in Menu.

Measured data record is an internal time control of data collection. It is suitable where it is necessary to register measured values. Two modes may be used. FAST is designed for fast storage (100 records/s) of all measured values up to 8 000 records. Second mode is RTC, where data record is governed by Real Time with data storage in a selected time segment and cycle. Up to 266 000 values may be stored in the instrument memory. Data transmission into PC via serial interface RS232/485 and OM Link.

3. INSTRUMENT CONNECTION



The instrument supply leads should not be in proximity of the incoming low-potential signals.

Contactors, motors with larger input power should not be in proximity of the instrument.

The leads into the instrument input (measured quantity) should be in sufficient distance from all power leads and appliances. Provided this cannot be secured it is necessary to use shielded leads with connection to ground (bracket E).

The instruments are tested in compliance with standards for use in industrial area, yet we recommend to abide by the above mentioned principles.

MEASURING RANGES

TYPE	INPUTS I	INPUTS U
DC	$\pm 999,99 \mu\text{A}$; $\pm 9,9999 \text{ mA}$; $\pm 99,999 \text{ mA}$; $\pm 999,99 \text{ mA}$; $\pm 5,0000 \text{ A}$	$\pm 999,99 \text{ mV}$; $\pm 999,99 \text{ mV}$; $\pm 9,9999 \text{ V}$; $\pm 99,999 \text{ V}$; $\pm 300,00 \text{ V}$
PM	0...5/20 mA/4...20 mA	$\pm 2/\pm 5/\pm 10 \text{ V}$
I	0...5/20 mA/4...20 mA	$\pm 2/\pm 5/\pm 10 \text{ V}$
LX	0...5/20 mA/4...20 mA	$\pm 2/\pm 5/\pm 10 \text{ V}$
DU	Linear potentiometer (min. 500 Ω)	
T	1..4 mV/V; 2..8 mV/V; 4..16 mV/V	

Termination of RS 485 communication line

X3 - Termination of communication line RS 485

Full	Significance	Default	Recommendation
1-2	connect L+ to (+) source	terminalconnected	connect at the end of line do not disconnect
3-4	termination of line 120 Ohm	disconnected	
5-6	connect L- to (-) source	terminalconnected	

RS 485 line should have a linear structure - wires (ideally shielded and twisted) should lead from one device to another.

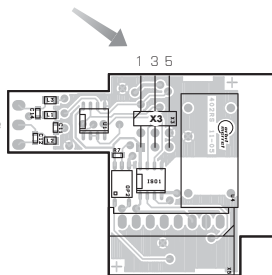

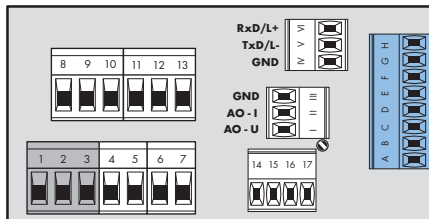
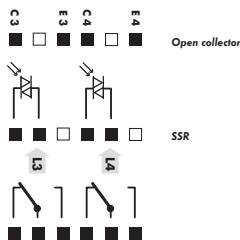

OM 502DC, PM, I, LX

- INPUT U
- INPUT I
- GND
- Shielding
- GND
- Excitation

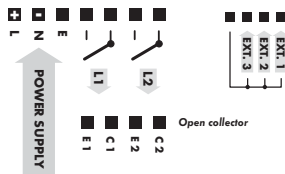

OM 502T



- DMS supply
- Sense
- INPUT
- INPUT
- Sense
- DMS supply
- Shielding

OM 502DU



Shielding

! Excitation value may be set by trimmer above the terminal block no. 17

! Grounding on terminal block 3 has to be connected at all times

! Signal „SENSE“ measures supply voltage on tensionmeter upon 6-wire connection, for 4-wire connection join brackets B+C and F+G directly on the instrument. When using the instrument in highly disturbing environment we recommend using 4-wire connection.

! Terminal block "Shielding" is designed for connecting shielding of the supply lead (connected only on the side of the instrument). The "Shielding" and "GND" terminal blocks **MUST NOT** be connected

3. INSTRUMENT CONNECTION

Example connection of a 2-wire sensor with current signal output powered by instrument's excitation

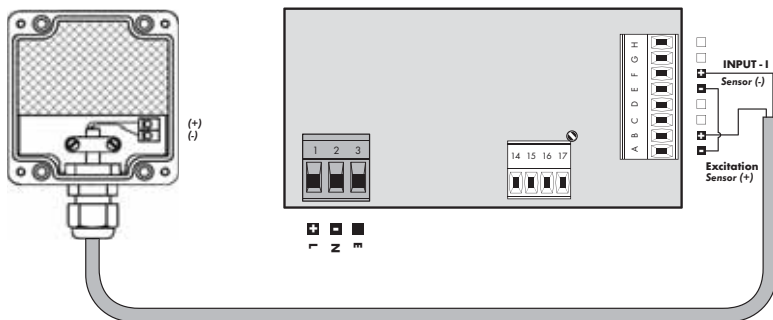

Example connection of a 3-wire sensor with current signal output powered by instrument's excitation

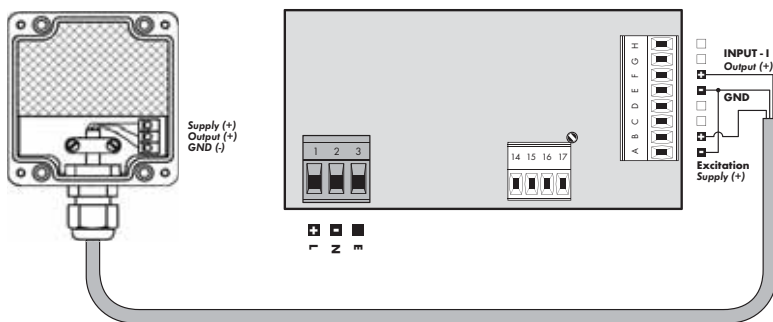

Example connection of 3-wire sensor with voltage signal output powered by instrument's excitation

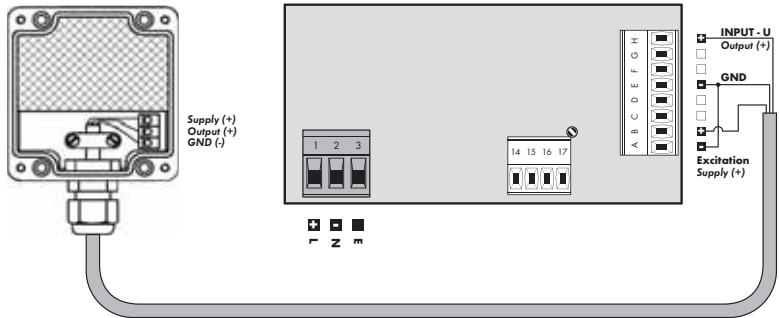



SETTING **PROFI**

For expert users

Complete instrument menu

Access is password protected

Possibility to arrange items of the **USER MENU**

Tree menu structure

SETTING **LIGHT**

For trained users

Only items necessary for instrument setting

Access is password protected

Possibility to arrange items of the **USER MENU**

Linear menu structure

SETTING **USER**

For user operation

Menu items are set by the user (Profi/Light) as per request

Access is not password protected

Optional menu structure either tree (PROFI) or linear (LIGHT)

4.1 SETTING

The instrument is set and controlled by five control keys located on the front panel. All programmable settings of the instrument are performed in three adjusting modes:

- LIGHT** **Simple programming menu**
 - contains solely items necessary for instrument setting and is protected by optional number code
- PROFI** **Complete programming menu**
 - contains complete instrument menu and is protected by optional number code
- USER** **User programming menu**
 - may contain arbitrary items selected from the programming menu (LIGHT/PROFI), which determine the right [see or change]
 - access without password

Complete instrument operation and setting may be performed via QM Link communication interface, which is a standard equipment of all instruments.

The operation program is freely accessible (www.orbit.merret.cz) and the only requirement is the purchase of QML cable to connect the instrument to PC. It is manufactured in version RS 232 and USB and is compatible with all ORBIT MERRET instruments. Another option for connection is with the aid of data output RS 232 or RS 485 (without the need of the QML cable).

Scheme of processing the measured signal

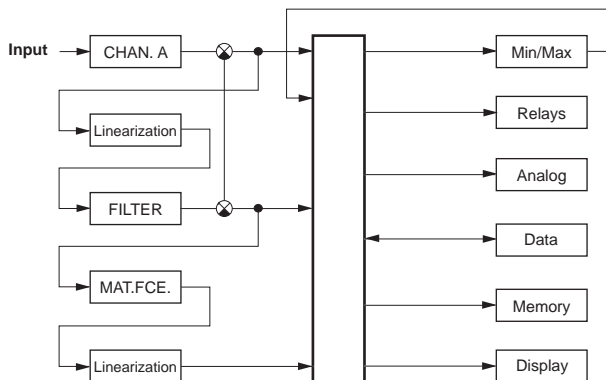

4. INSTRUMENT SETTING

Setting and controlling the instrument is performed by means of 5 control keys located on the front panel. With the aid of these keys it is possible to browse through the operation menu and to select and set required values.

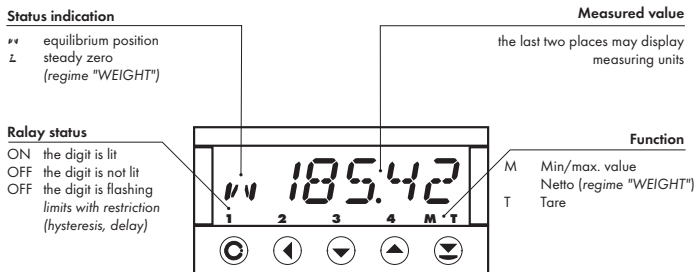

Symbols used in the instructions



Indicates the setting for given type of instrument



values preset from manufacture



symbol indicates a flashing light (symbol)



inverted triangle indicates the item that can be placed in USER menu



broken line indicates a dynamic item, i.e. it is displayed only in particular selection/version



after pressing the key the set value will not be stored



after pressing the key the set value will be stored



continues on page 30

Setting the decimal point and the minus sign

DECIMAL POINT

Its selection in the menu, upon modification of the number to be adjusted it is performed by the control key with transition beyond the highest decade, when the decimal point starts flashing. Positioning is performed by .

THE MINUS SIGN

Setting the minus sign is performed by the key on higher decade. When editing the item subtraction must be made from the current number (e.g.: 013 > , on class 100 > -87)

Control keys functions

KEY	MEASUREMENT	MENU	SETTING NUMBERS/SELECTION
	access into USER menu	exit menu	quit editing
	programmable key function	back to previous level	move to higher decade
	programmable key function	move to previous item	move down
	programmable key function	move to next item	move up
	programmable key function	confirm selection	confirm setting/selection
			numeric value is set to zero
	access into LIGHT/PROFI menu		
	direct access into PROF1 menu		
		configuration of an item for "USER" menu	
		determine the sequence of items in "USER - LIGHT" menu	

Setting items into „USER“ menu

- in **LIGHT** or **PROFI** menu
- no items permitted in **USER** menu from manufacture
- on items marked by inverted triangle

USER

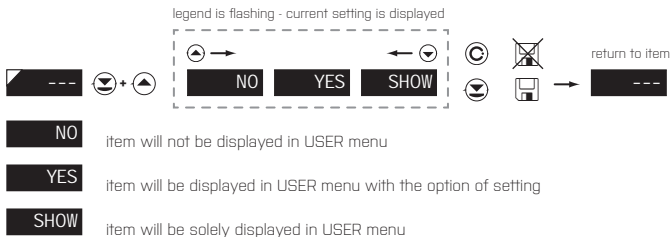



SETTING LIGHT

For trained users

Only items necessary for instrument setting

Access is password protected

Possibility to arrange items of the **USER MENU**

Linear menu structure



Upon delay exceeding 60 s the programming mode is automatically discontinued and the instrument itself restores the measuring mode

Preset from manufacture

Password	"0"
Menu	LIGHT
USER menu	off
Setting the items	DEF

1428

Access password

PASSW

0

DC Setting projection
 MIN A MAX A FORM.A
PM Selecting measuring range/Projection setting
 MODE MIN A MAX A FORM.A
I Selecting measuring range/Projection setting/Setting multiplying and dividing constantly
 MODE MAX A MAX A SCALE DI V I D FORM.A
LX Selecting measuring range/Projection setting/Table selection
 MODE MAX A MAX A TAB x FORM.A
DU Setting projection
 MIN A MAX A FORM.A
T Selecting measuring mode/Setting projection and tensionmeter sensitivity
 MODE MAX A SENSE MAX.W FORM.A
 LIM.L1 LIM.L2 LIM.L3 LIM.L4

Option - Comparators

 TYP.A0. MI N A0. MAX A0.

Option - Analog output

 Menu type MENU Return to manufacture calibration RE.CAL. Return to manufacture setting RE.SET.

Calibration - only for "DU"

 C.MI N C.MAX

 Language selection LANG. New password PAS.LI. Identification IDENT. Typy of instr. SW version Input
Return to measuring mode

5. SETTING LIGHT

1428



PASSW.



0

Entering access password
for access into the menu



PASSW. Access into instrument menu

PAS = 0

- access into menu is unrestricted, after releasing
keys you automatically move to first item of the
menu

PAS > 0

- access into menu is protected by number code

Set "Password" = 42

Example



Type „DC“	18
Type „PM“	20
Type „I“	22
Type „LX“	24
Type „DU“	26
Type „T“	28



5. SETTING LIGHT

FOR INSTRUMENT > OM 502DC



MIN A **Setting display projection for minimum value of input signal**

- range of the setting: ±99999 [-99999...99999]
- position of the DP does not affect display projection

- the DP is automatically shifted after the value is confirmed

DEF = 0

Projection for 0 mV > MIN A = -25 Example

0	1	2	3	4	5
0.5	1.5	2.5	3.5	4.5	5.5

MAX A



MAX A **Setting display projection for maximum value of input signal**

- range of the setting: ±99999 [-99999...99999]
- position of the DP does not affect display projection

- the DP is automatically shifted after the value is confirmed

DEF = 100

Projection for 999.9 mV > MAX A = 3500 Example

100	100	100	200	300	400
500	0500	1500	2500	3500	FORM A

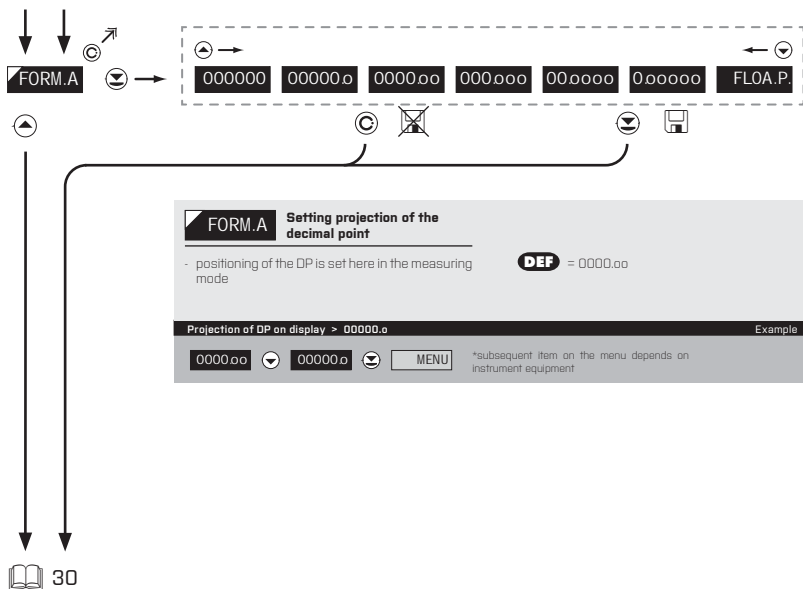

5. SETTING LIGHT

FOR INSTRUMENT > OM 502PM

The diagram illustrates the navigation path for setting the instrument measuring range and minimum input signal. It starts with the **MODE** menu, which leads to a range selection screen. From there, it goes to the **MIN A** menu, which leads to a setting screen for the minimum input signal.

MODE Selection of the instrument measuring range

DEF = 4 - 20 mA

Menu	Range
0-5mA	0...5 mA
0-20mA	0...20 mA
4-20mA	4...20 mA
0-2 V	±2 V
0-5 V	±5 V
0-10 V	±10 V
Er4-20	4...20 mA, with error statement of „underfl ow“ upon signal smaller than 3.36 mA

Range: 0...20 mA Example

4-20mA | 0-20mA | MIN A

MIN A Setting for minimum input signal

DEF = 0

Setting for minimum input signal

MIN A Setting display projection for minimum value of input signal

- range of the setting: ±99999 [-99999...99999]
- position of the DP does not affect display projection
- the DP is automatically shifted after the value is confirmed

DEF = 0

Projection for 0 mA > MIN A = -25 Example

0 | 0.5 | -5 | -0.5 | -1.5 | -2.5 | MAX A



MAX A **Setting display projection for maximum value of input signal**

- the DP is automatically shifted after the value is confirmed
- range of the setting: ±99999 [-99999...99999]
- position of the DP does not affect display projection

DEF = 100

Projection for 20 mA > MAX A = 2500 Example

100	100	100	200	300	400
500	0500	1500	2500	FORM.A	

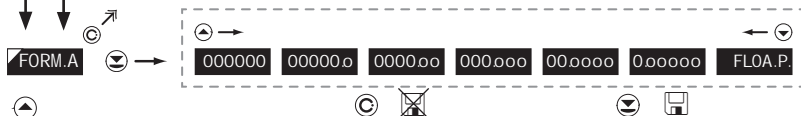

FORM.A **Setting projection of the decimal point**

- positioning of the DP is set here in the measuring mode

DEF = 0000.00

Projection of DP on display > 00000.0 Example

0000.00	00000.0	MENU
---------	---------	------

*subsequent item on the menu depends on instrument equipment

5. SETTING LIGHT

FOR INSTRUMENT > OM 502I

The diagram illustrates the navigation path for setting the instrument's measuring range and display projection. It starts with the **MODE** menu, which lists various ranges: 0-5mA, 0-20mA, 4-20mA, ..., 0-10 V, 0-40 V, and Er4-20. The selected range is 4-20 mA.

From the **MODE** menu, the user can navigate to **MIN A** (Setting for minimum input signal) or **MAX A** (Setting for maximum input signal). The **MIN A** setting is currently 0, and the **MAX A** setting is currently 100.

The **MIN A** screen shows the setting for minimum input signal and the display projection for the minimum value of the input signal. The range of the setting is ±99999 {99999...999999}. The projection for 0 mA > MIN A = -10. The **DEF** is 0.

The **MAX A** screen shows the setting for maximum input signal and the display projection for the maximum value of the input signal. The range of the setting is ±99999 {99999...999999}. The projection for 20 mA > MAX A = 2500. The **DEF** is 100.

The **MODE** menu table is as follows:

Menu	Range
0-5mA	0...5 mA
0-20mA	0...20 mA
4-20mA	4...20 mA
0-2 V	+2 V
0-5 V	+5 V
0-10 V	+10 V
Er4-20	4...20 mA, with error statement of „underfl ow“ upon signal smaller than 3.36 mA

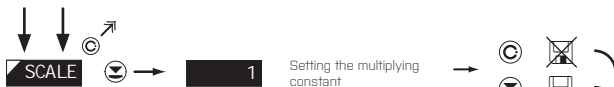

SCALE Setting the multiplying constant **DEF** = 1

- range of the setting is 1..100 000
- by using the multiplying and dividing constant it is easy to set the displayed value for required time period

Multiplying constant - 1 > SCALE = 1 Example

DIVID



DIVID. Selecting the dividing constant **DEF** = 1

- range 1/10/60/100/1 000/3 600
- by using the multiplying and dividing constant it is easy to set the displayed value for required time period

Dividing constant - 3600 > DIVID. = 3600 Example

1 3600 FORM.I

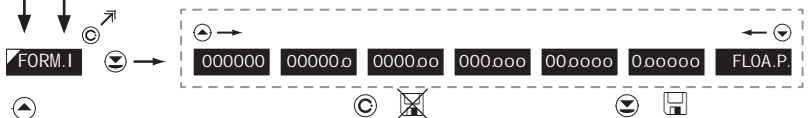

FORM.I Setting projection of the decimal point **DEF** = 0000.00

- positioning of the DP is set here in the measuring mode

Projection of DP on display > 00000.0 Example

0000.00 00000.0 MENU *subsequent item on the menu depends on instrument equipment

5. SETTING LIGHT

FOR INSTRUMENT > OM 502LX

The diagram illustrates the navigation path for setting the instrument's measuring range and display projection. It starts with the **MODE** menu, which lists various ranges: 0-5mA, 0-20mA, 4-20mA, ..., 0-10 V, 0-40 V, and Er4-20. The selected range is 4-20 mA.

From the **MODE** menu, the user can navigate to the **MIN A** setting. The **MIN A** setting is currently set to 0. The description indicates it is the "Setting for minimum input signal".

From the **MIN A** setting, the user can navigate to the **MAX A** setting. The **MAX A** setting is currently set to 100. The description indicates it is the "Setting for maximum input signal".

The **MIN A** configuration screen shows the following details:

- MODE**: Selection of the instrument measuring range
- DEF**: = 4 - 20 mA
- Range**: 0...20 mA
- Example**: 4-20mA, 0-20mA, MIN A

The **MAX A** configuration screen shows the following details:

- MAX A**: Setting display projection for maximum value of input signal
- range of the setting: ±99999 {99999...999999}
- DEF**: = 100
- Example**: Projection for 20 mA > MAX A = 2500

Additional notes for both MIN A and MAX A settings:

- position of the DP does not affect display projection
- the DP is automatically shifted after the value is confirmed

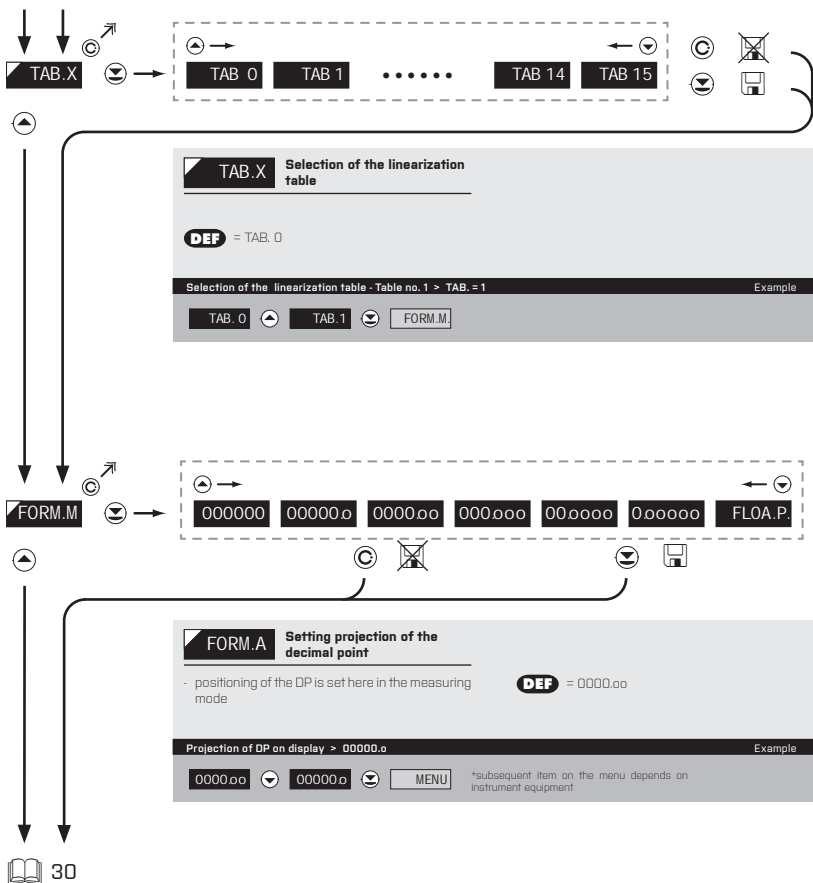

5. SETTING LIGHT

FOR INSTRUMENT > OM 502DU



MIN A **Setting display projection for minimum value of input signal**

- range of the setting: ±99999 [-99999...99999]
- position of the DP does not affect display projection

- the DP is automatically shifted after the value is confirmed

DEF = 0

Projection for the beginning > MIN A = 0 Example

0
MAX A



MAX A **Setting display projection for maximum value of input signal**

- range of the setting: ±99999 [-99999...99999]
- position of the DP does not affect display projection

- the DP is automatically shifted after the value is confirmed

DEF = 100

Projection for the end > MAX A = 5000 Example

100

100

100

000

0000

1000

2000

3000

4000

5000

FORM.A

FORM.A

000000 00000.0 0000.00 000.000 00.0000 0.00000 FLOA.P.

FORM.A **Setting projection of the decimal point**

- positioning of the DP is set here in the measuring mode **DEF** = 0000.00

Projection of DP on display > 00000.0 Example

0000.00	00000.0	MENU	*subsequent item on the menu depends on instrument equipment
---------	---------	------	--

30 Calibration of the beginning and the end of range of linear potentiometer is on page 35

5. SETTING LIGHT

FOR INSTRUMENT > OM 502T

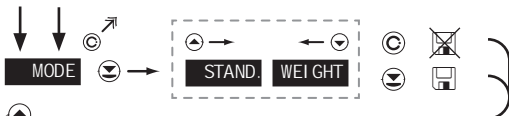

MODE Selection of measuring mode

- when mode „WEIGHT“ is selected these functions are active:
 - signalling of stable value (after the scales shake has stopped - stable signal)
 - stable zero (no weight on the scales - stable signal)
 - automatic following of zero (eliminates creeping over time caused by load cell deformation)
- automatic zeroing of tare (after weight is taken off the scales)
- defined number of scale divisions

DEF = STAND.

MODE	Menu	Measuring mode
	STAND.	Standard
	WEIGHT	Weighing function

Mode "WEIGHT" Example

STAND. WEIGHT MAX A



MAX A Setting display projection for maximum value of input signal

- range of the setting: ± 99999 [-99999...99999]
- position of the DP does not affect display projection
- the DP is automatically shifted after the value is confirmed

DEF = 100

Weighing range is -200 kg > MAX A = 200 Example

100 100 100 100 SENSE

!

Items in the menu "Manual Calibration":

MAX A Sensor range
SENSE Sensor sensitiveness

Items in the menu "Automatic Calibration":
(after calibration in menu "SERVIS/KALIB.")

MIN A The load at which minimum calibration was performed
MAX A The load at which maximum calibration was performed
- for maximum calibration we recommend the value of reference load to be in the upper third of the measuring range

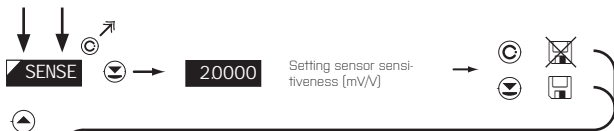

SENSE **Setting display projection for maximum input signal value**

- range of the setting: 0,2...4,0 [1...4 mV/V]
- range of the setting: 0,4...8,0 [2...8 mV/V]
- range of the setting: 0,8...16,0 [1...4 mV/V]

- DP is automatically shifted after the value is confirmed

DEF = 2.0000

Sensitiveness 2,0018 mV/V > SENSE = 2.0018 Example

23 24 25 25 35 FORM.A

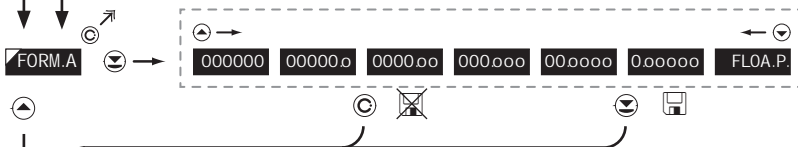

FORM.A **Setting projection of the decimal point**

- positioning of the DP is set here in the measuring mode

DEF = 0000.00

Projection of DP on display > 00000.0 Example

0000.00 00000.0 MENU *subsequent item on the menu depends on instrument equipment

5. SETTING LIGHT

DISPLAYED ONLY WITH OPTIONS > COMPARATORS

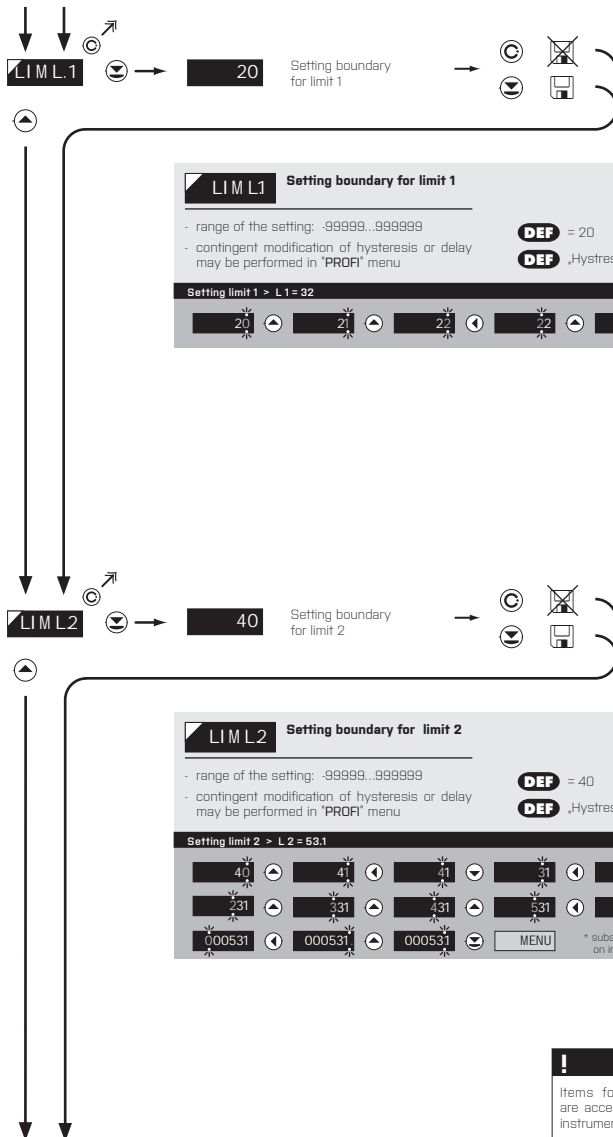

!
Items for "Limits" and "Analog output" are accessible only if incorporated in the instrument.

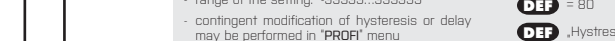
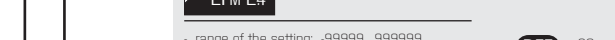
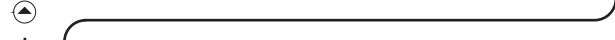
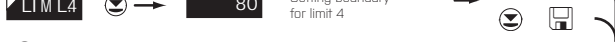
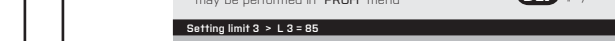
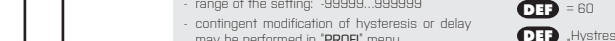
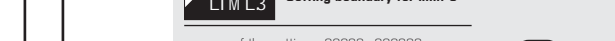
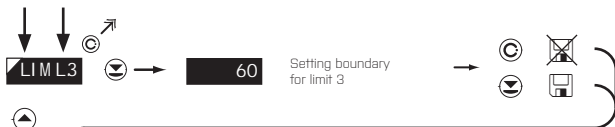

LIM L3

Setting boundary for limit 3

- range of the setting: -99999...999999 **DEF** = 60

- contingent modification of hysteresis or delay may be performed in 'PROF' menu **DEF** „Hysteresis“=0, „Delay“=0

Setting limit 3 > L 3 = 85

Example

60	61	62	63	64	65
65	75	85	MENU	* subsequent item on the menu depends on instrument equipment	

LIM L4

Setting boundary for limit 4

- range of the setting: -99999...999999 **DEF** = 80

- contingent modification of hysteresis or delay may be performed in 'PROF' menu **DEF** „Hysteresis“=0, „Delay“=0

Setting limit 4 > L 4 = 103

Example

80	81	82	83	83	93
03	003	103	MENU	* subsequent item on the menu depends on instrument equipment	

5. SETTING LIGHT

DISPLAYED ONLY WITH OPTIONS > ANALOG OUTPUT

0-20mA Er4-T 4-20 T Er4-20 ... 0-10 V +10 V

TYP.A.O. Setting the type of analog output

Menu	Range	Description
0-20mA	0...20 mA	
Er4-T	4...20 mA	with error message indication and broken loop indication (<3,6 mA)
4-20T	4...20 mA	with broken loop indication (<3,6 mA)
Er4-20	4...20 mA	with indication of error statement (<3,6 mA)
4-20mA	4...20 mA	
0.5mA	0...5 mA	
0.2 V	0...2 V	
0.5 V	0...5 V	
0-10 V	0...10 V	
+10 V	±10 V	

DEF = 4...20 mA

Type of analog output - 0...10 V > TYP. A.O. = 0-10 V Example

4-20mA 0-5mA 0-2 V 0-5 V 0-10 V MIN.A.O.

MIN.A.O. Assigning the display value to the beginning of the AD range

DEF = 0

- range of the setting: -99999...999999

Display value for the beginning of the AD range > MIN.A.O. = 0 Example

0 MAX.A.O.

!

Items for "Limits" and "Analog output" are accessible only if incorporated in the instrument.

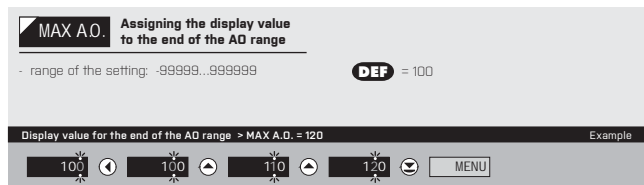

DISPLAYED ONLY WITH OPTIONS > ANALOG OUTPUT

5. SETTING LIGHT

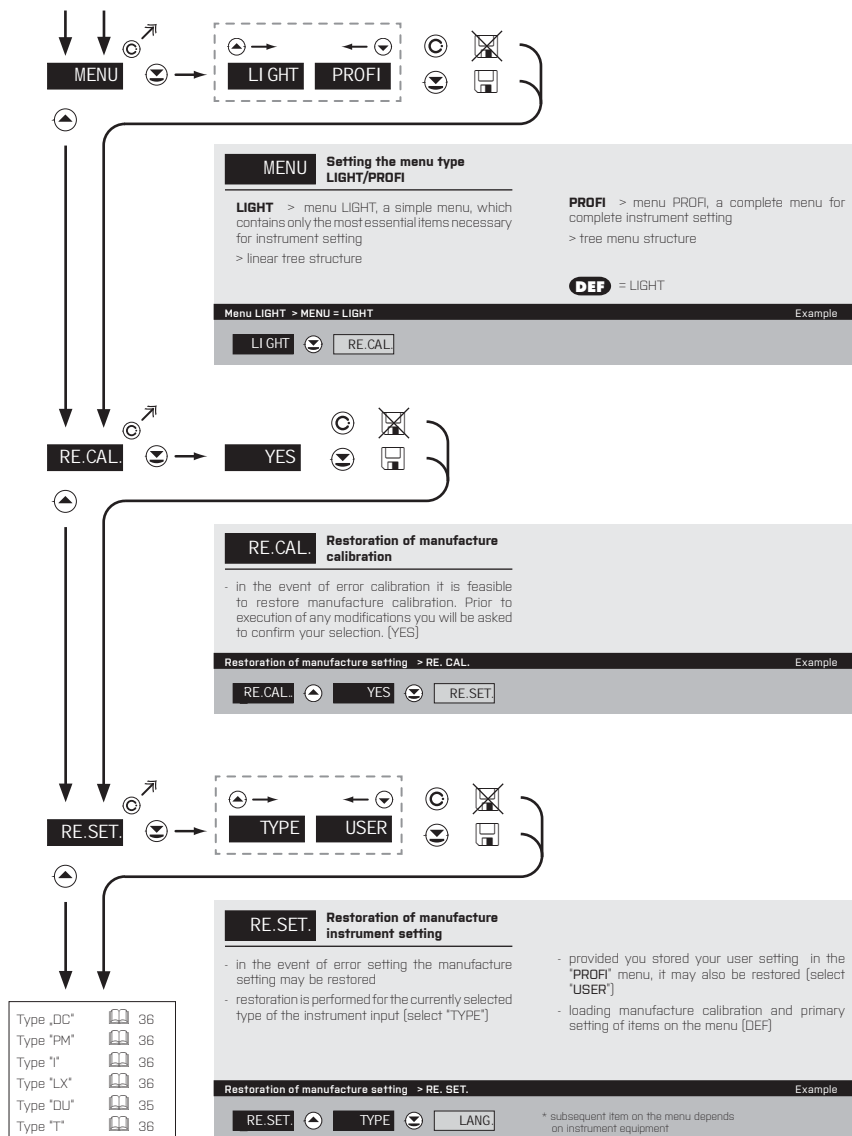

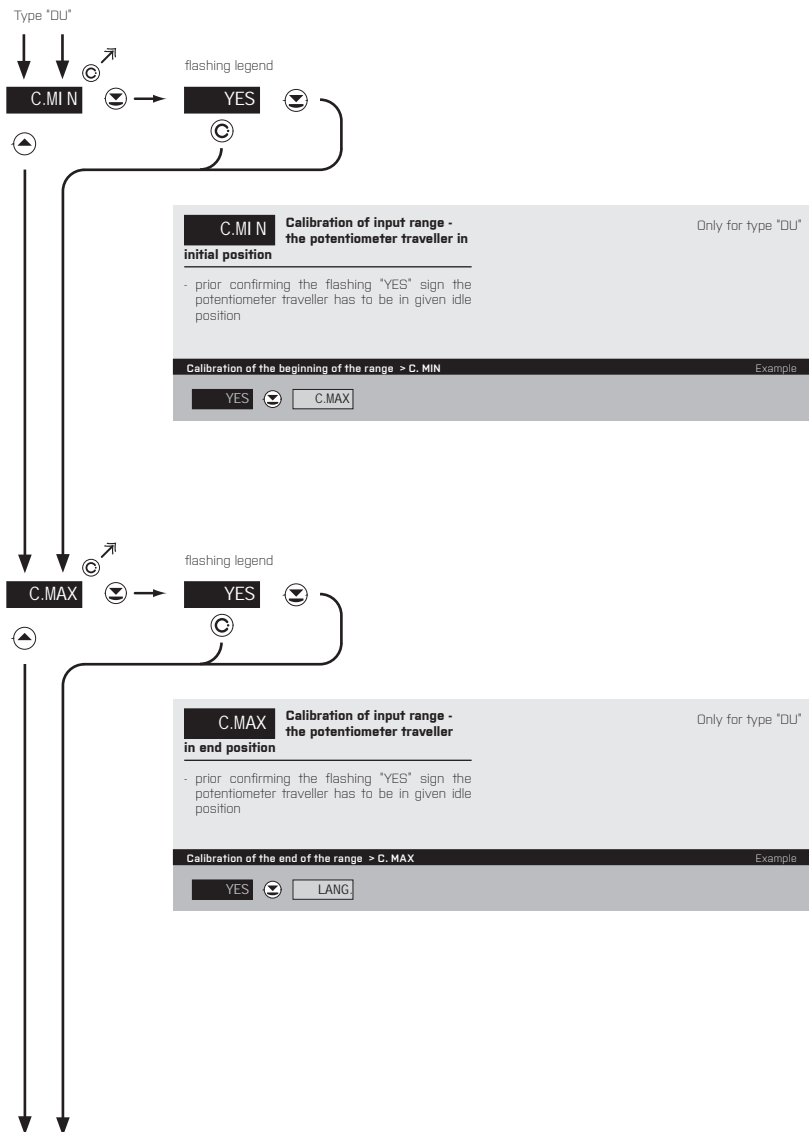

5. SETTING LIGHT

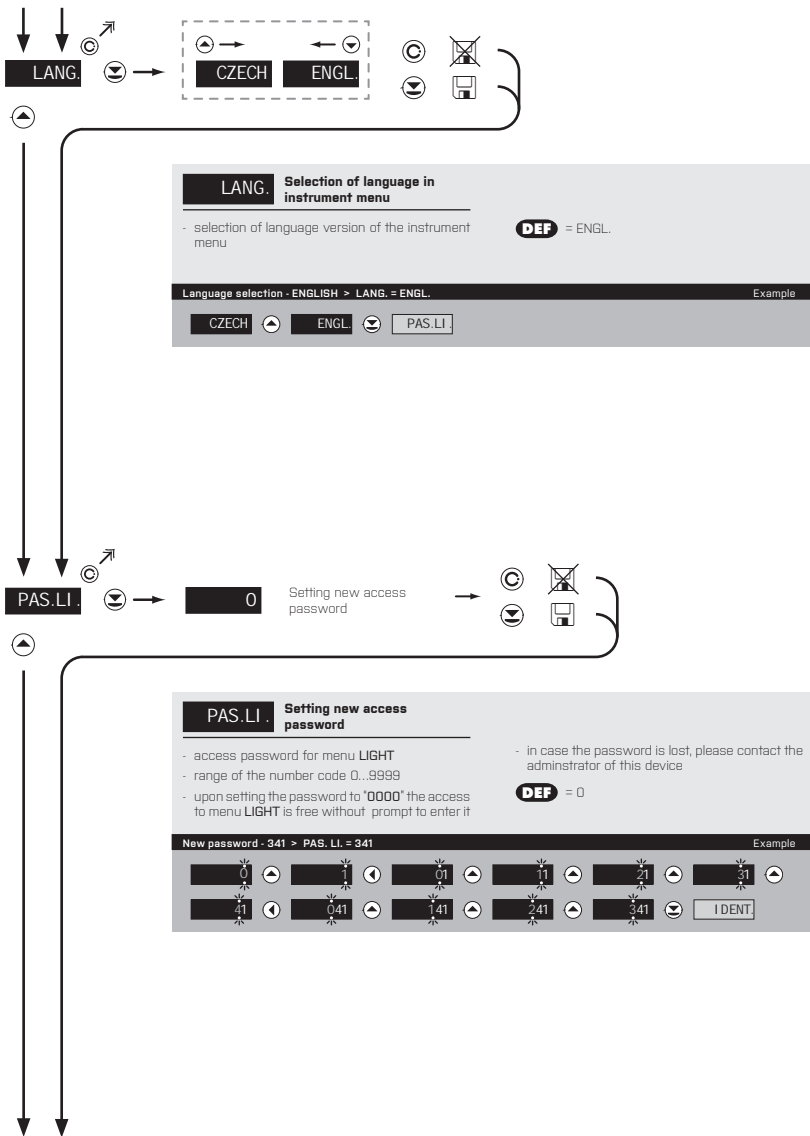

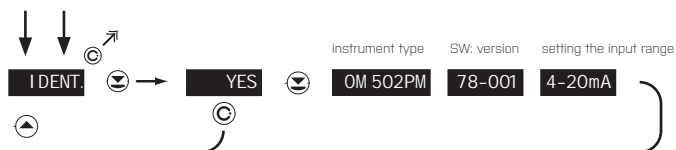

I DENT. Instrument SW version

- the display shows the type of instrument indication, SW number, SW version and current input setting [Mode]
- if SW version contains a letter in first position, then it is a customer SW
- after the identification is completed the menu is automatically exited and the instrument restores the measuring mode

1428

Return to measuring mode



SETTING **PROFI**

For expert users

Complete instrument menu

Access is password protected

Possibility to arrange items of the **USER MENU**

Tree menu structure

6.0

SETTING "PROFI"

PROFI

Complete programming menu

- contains complete instrument menu and is protected by optional number code
- designed for expert users
- preset from manufacture is menu **LIGHT**

Switching over to "PROFI" menu



- access to **PROFI** menu
- authorization for access to **PROFI** menu does not depend on setting under item **SERVIC. > MENU**
- password protected access (unless set as follows under the item **SERVIC. > N. PASS. > PROFI =0**)



- access to menu selected under item **SERVIC. > MENU > LIGHT/PROFI**
- password protected access (unless set as follows under the item **SERVIC. > N. PASS. > LIGHT =0**)
- for access to **LIGHT** menu passwords for **LIGHT** and **PROFI** menu may be used



6. SETTING PROFI

6.1 SETTING "PROFI" - INPUT

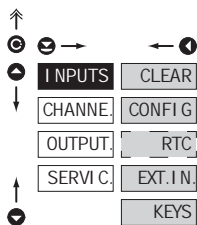

The primary instrument parameters are set in this menu

CLEAR	Resetting internal values
CONFIG.	Selection of measuring range and parameters
RTC	Setting date and time for option with RTC
EXT.IN.	Setting external inputs functions
KEYS	Assigning further functions to keys on the instrument

6.1.1 RESETTING INTERNAL VALUES

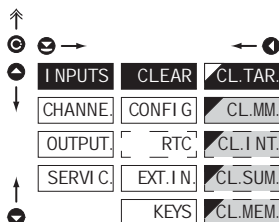

CLEAR	Resetting internal values
CL.TAR.	Tare resetting
CL.MM.	Resetting min/max value
- resetting memory for the storage of minimum and maximum value achieved during measurement	
CL.INT.	Resetting integrated value
- only for instrument OM 502I	
CL.SUM.	Resetting the sum
- summation serves for cumulative totals of values (e.g. shift operation), when after resetting the integrator ["N.INT"] the display value is added to the total ["SUM"]	
- only for instrument OM 502I	
CL.MEM.	Resetting the instrument memory
- resetting memory with data measured in the "FAST" or "RTC" modes	
- not in standard equipment	

6.1.2a

SELECTION OF MEASURING RATE

Navigation icons: ↑, Ⓞ, →, ←, Ⓞ, ↓, ↕

INPUTS	CLEAR	READ/S	1000	
CHANNE.	CONF I G	MODE	667	
OUTPUT.	RTC	TRACE0	500	
SERVIC.	EXT.I N	A.ZERO	250	
	KEYS		125	
			100	
			80	
			40	DEF
			20	
			10	DEF WEIGHT
			05	
			03	
			01	

READ/S Selection of measuring rate

READ/S	Selection of measuring rate
1000	100,0 measurement/s
667	66,7 measurement/s
500	50,0 measurement/s
250	25,0 measurement/s
125	12,5 measurement/s
100	10,0 measurement/s
80	8,0 measurement/s
40	4,0 measurement/s
DEF	
20	2,0 measurement/s
10	1,0 measurement/s
DEF	for OM 502T > mode WEIGHT
05	0,5 measurement/s
03	0,3 measurement/s
01	0,1 measurement/s

6. SETTING PROFI

6.1.2b

SELECTION OF MEASURING RANGE/MODE

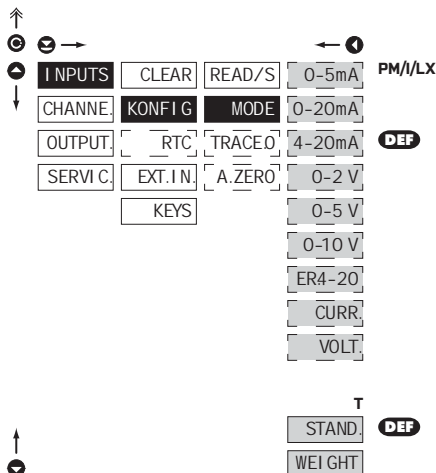

MODE Selection of measuring range/mode

MODE	Menu	Measuring range
	0-5mA	0...5 mA
	0-20mA	0...20 mA
	4-20mA	4...20 mA
	0-2 V	±2 V
	0-5 V	±5 V
	0-10 V	±10 V
	Er4-20	4...20 mA, with error statement of „underflow“ upon signal smaller than 3.36 mA
	CURR.	Current range after automatic calibration
	VOLT.	Voltage range after automatic calibration

MODE	Menu	Measuring range
	STAND.	Standard mode
	WEIGHT	Weighing mode

6.1.2c

SELECTION OF AUTOMATIC ZERO MONITORING

T

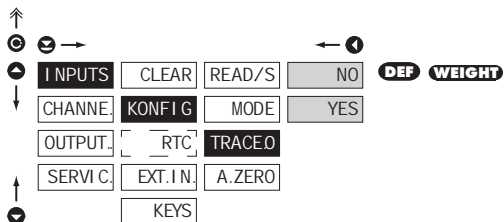

TRACE O Selection of automatic zero monitoring

NO	Function is off
YES	Function is on

- in 4% of the measuring range zero automatically faces the condition that correction must not be larger than 0.5 section/sec
- setting is possible only for mode "WEIGHT"

6.1.2d SELECTION OF AUTOMATIC WEIGHT RESETTING

T

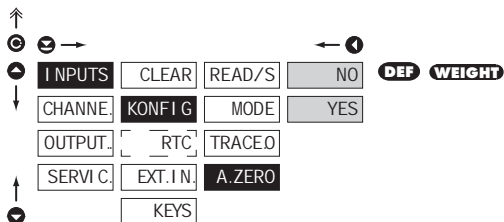

A.ZERO Selection of automatic weight resetting

NO Function is off

YES Function is on

- if stabilized negative value is displayed for a period > 5 s (at active Tare function) the tare is automatically reset
- selection is possible only for mode "WEIGHT"

6.1.3 SETTING THE REAL TIME CLOCK

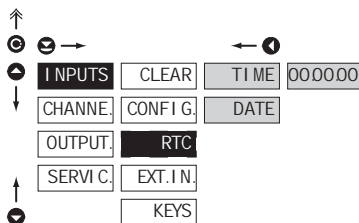

RTC Setting the real time clock (RTC)

TIME Time setting

- format 23.59.59

DATE Date setting

- format DD.MM.YY

6. SETTING PROFI

Programming sche

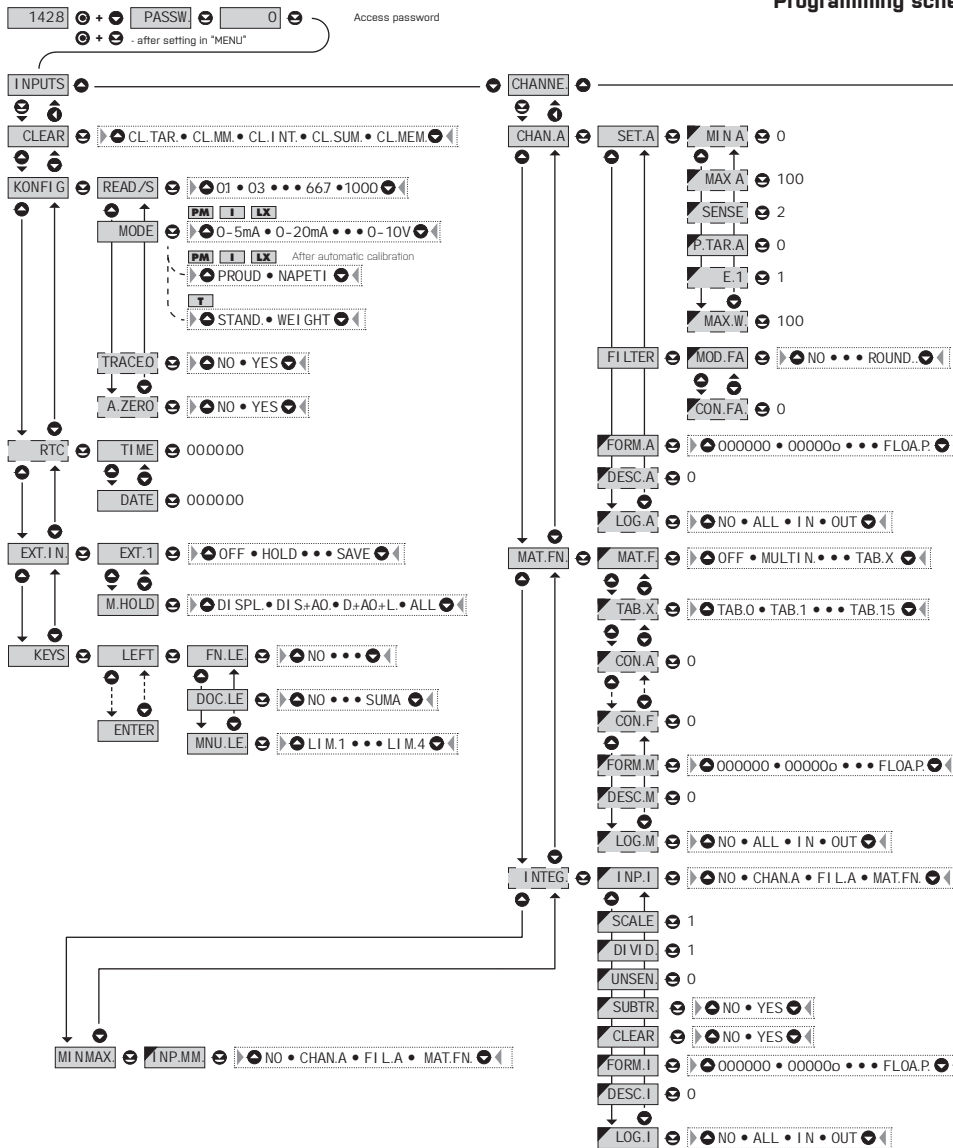

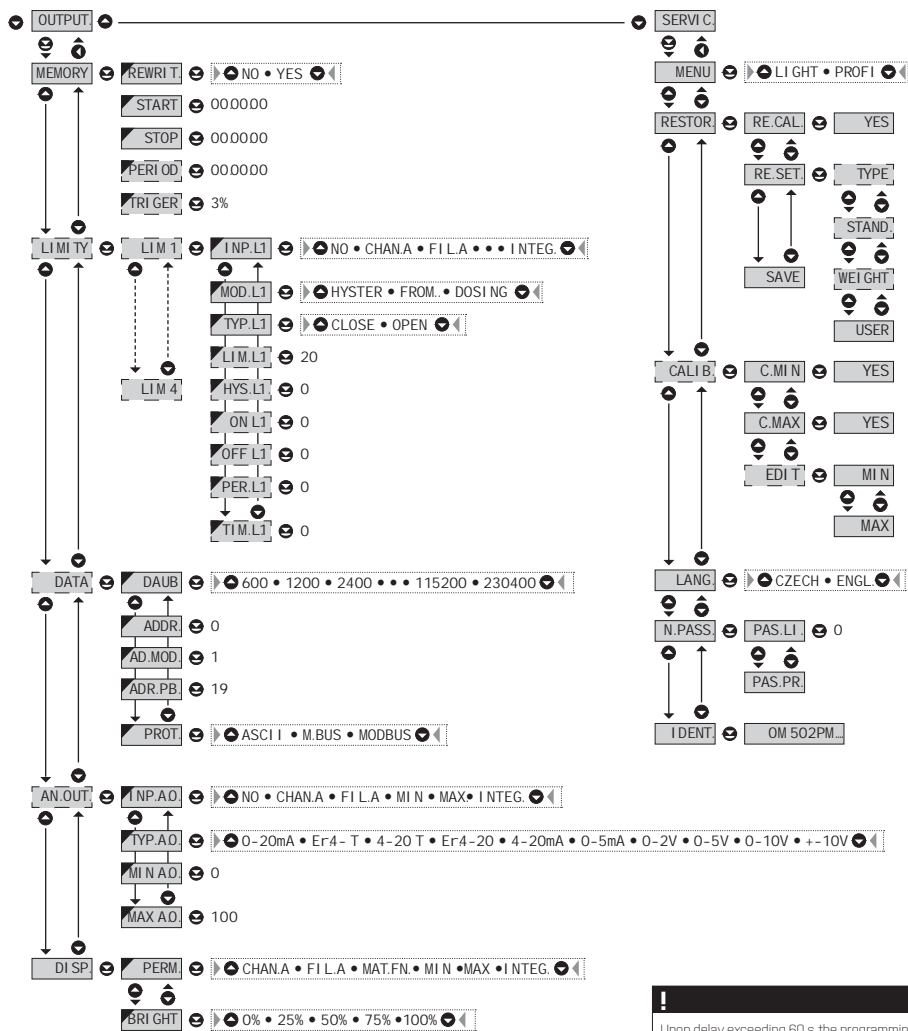

Upon delay exceeding 60 s the programming mode is automatically discontinued and the instrument itself restores the measuring mode

6. SETTING PROFI

6.1.4a

EXTERNAL INPUT FUNCTION SELECTION

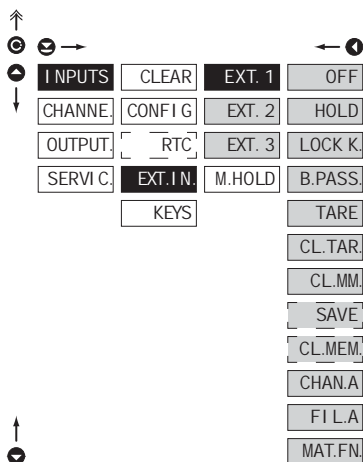

EXT. I.N. External input function selection

OFF	Input is off
HOLD	Activation of HOLD
LOCK K.	Locking keys on the instrument
B.PASS.	Activation of locking access into programming menu
LIGHT/PROFI	
TARE	Tare activation
CL.TAR.	Tare resetting
CL.MM.	Resetting min/max value
SAVE	Activation of the measured data record into instrument memory (not in standard equipment)
CL.I.NT.	Resetting integrated value
- only for instrument DM 502I	
CL.SUM.	Resetting the sum
- only for instrument DM 502I	
CL.MEM.	Clearing memory for option FAST/RTC
CHAN.A	Displaying value of "Channel A"
FI L.A	Displaying value of "Channel A" after being processed by digital filters
MAT.FN.	Displaying value of "Mathematical function"

- **DEF** EXT. 1 > HOLD
- **DEF** EXT. 2 > LOCK K.
- **DEF** EXT. 3 > TARE

*

Procedure identical for EXT. 2 and EXT. 3

6.1.4b SELECTION OF FUNCTION "HOLD"

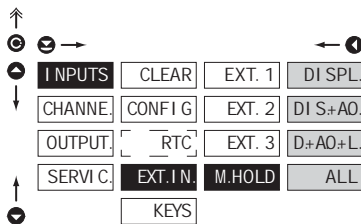

M.HOLD Selection of function "HOLD"

DI SPL.	"HOLD" locks only the value displayed
DI S+AO.	"HOLD" locks the value displayed and on AO
D+AO+L.	"HOLD" locks the value displayed, on AO and limit evaluation
ALL	"HOLD" locks the entire instrument

6.1.5a OPTIONAL ACCESSORY FUNCTIONS OF THE KEYS

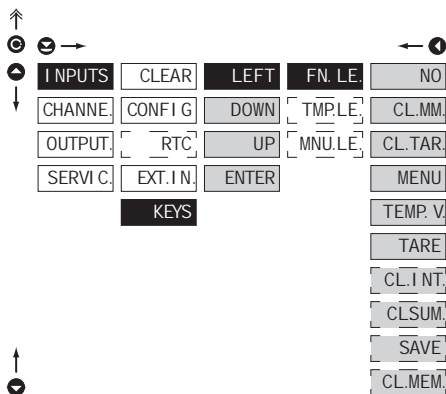

FN. LE. Assigning further functions to instrument keys

- „FN. LE.“ > executive functions

NO	Key has no further function
CL.MM.	Resetting min/max value
CL.TAR.	Tare resetting
MENU	Direct access into menu on selected item
TEMP.V.	Temporary projection of selected values
TARE	Tare function activation
CL.I NT.	Resetting integrated value (only for QM 502)
CL.SUM.	Resetting the sum (only for QM 502)
SAVE	Activation of measured data recording in instrument's memory (not in standard equipment)
CL.MEM.	Clearing memory

- after confirmation of this selection the "MNU. LE." item is displayed on superior menu level, where required selection is performed

- after confirmation of this selection the item "TMP. LE." is displayed on superior menu level, where required selection is performed

- storing the requested value into the memory after pressing a designated key

- clearing memory with data measured in modes "FAST" or "RTC"

!

Preset values of the control keys **DEF**

LEFT	Show Tare
UP	Show Max. value
DOWN	Show Min. value
ENTER	w/o functions

!

Setting is identical for LEFT, DOWN, UP and ENTER

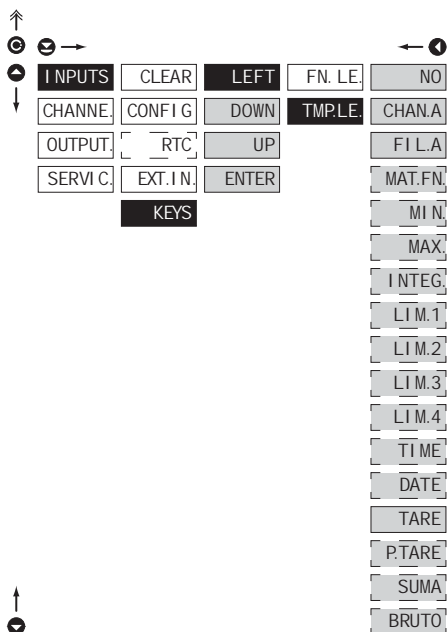
**TMP. LE.** Temporary projection of selected item

- "TMP. LE." > temporary projection of selected values
- "Temporary" projection of selected value is displayed for the time of keystroke
- "Temporary" projection may be switched to permanent by pressing **C** + "Selected key", this holds until the stroke of any key

NO	Temporary projection is off
CHAN.A	Temporary projection of "Channel A" value
FILA	Temporary projection of "Channel A" value after processing digital filters
MAT.FN.	Temporary projection of "Mathematic functions" value
MIN	Temporary projection of "Min. value"
MAX	Temporary projection of "Max. value"
INTEG.	Temporary projection of "Integrated value"
LIM 1	Temporary projection of "Limit 1" value
LIM 2	Temporary projection of "Limit 2" value
LIM.3	Temporary projection of "Limit 3" value
LIM.4	Temporary projection of "Limit 4" value
TIME	Temporary projection of "TIME" value
DATE	Temporary projection of "DATE" value
TARE	Temporary projection of "TARE" value
P.TARE	Temporary projection of "P. TARE" value
SUMA	Temporary projection of "SUM" (only for QM 502)
BRUTO	Temporary projection of the sum of the values of "CHAN. A + TARE + PTARE"



Setting is identical for **LEFT**, **DOWN**, **UP** and **ENTER**

6.1.5c

OPTIONAL ACCESSORY FUNCTIONS OF THE KEYS - DIRECT ACCESS TO ITEM

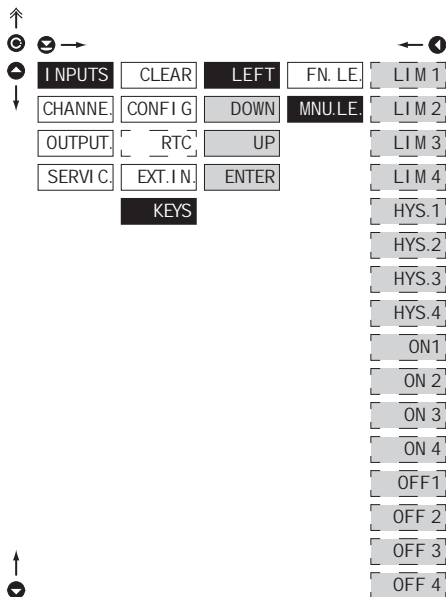
**MNU.LE.** Assigning access to selected menu item

- „MNU.LE.“ > direct access into menu on selected item

LIM 1	Direct access to item "LIM 1"
LIM 2	Direct access to item "LIM 2"
LIM 3	Direct access to item "LIM 3"
LIM 4	Direct access to item "LIM 4"
HYS.1	Direct access to item "HYS. 1"
HYS.2	Direct access to item "HYS. 2"
HYS.3	Direct access to item "HYS. 3"
HYS.4	Direct access to item "HYS. 4"
ON 1	Direct access to item "ON 1"
ON 2	Direct access to item "ON 2"
ON 3	Direct access to item "ON 3"
ON 4	Direct access to item "ON 4"
OFF 1	Direct access to item "OFF 1"
OFF 2	Direct access to item "OFF 2"
OFF 3	Direct access to item "OFF 3"
OFF 4	Direct access to item "OFF 4"

! Setting is identical for **LEFT**, **DOWN**, **UP** and **ENTER**

6. SETTING PROFI

6.2 SETTING "PROFI" - CHANNELS

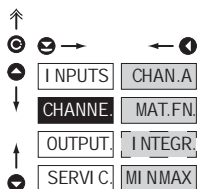

The primary instrument parameters are set in this menu

CHAN. A	Setting parameters of measuring "Channel"
MAT. FN.	Setting parameters of mathematic functions
I NTEGR.	Setting parameters for integrator (QM 502)
MI NMAX	Selection of access and evaluation of Min/max value

6.2.1a PROJECTION ON DISPLAY - MANUAL CALIBRATION

DC PM DU I LX

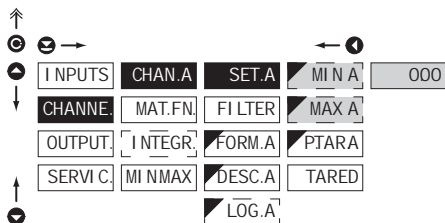

SET. A Setting display projection

MI N A	Setting display projection for minimum value of input signal
	- range of the setting is -99999...999999
	- menu is dynamic, after using automatic calibration this item is no more displayed
	- DEF = 0.00
MAX A	Setting display projection for maximum value of input signal
	- range of the setting is -99999...999999
	- DEF = 100.00

6.2.1b PROJECTION ON DISPLAY - MANUAL CALIBRATION

T

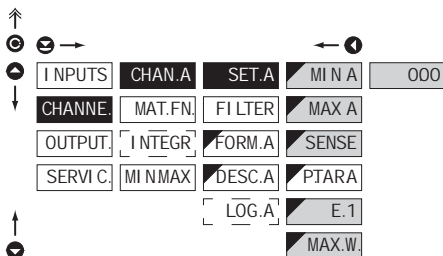

!

Manual calibration

MAX Sensor range
SENSE Sensor sensitiveness

Automatic calibration
(after calibration in menu "SERVIS/KALIB.")

MIN Size of load with which minimum calibration was performed

MAX Size of load with which maximum calibration was performed

- upon maximum calibration we recommend the reference load value in the upper third of the measuring range

SET.A Setting display projection

MI N A Setting display projection for minimum value of input signal

- range of the setting is -99999...999999
- menu is dynamic, in manual calibration this item is not displayed

- **DEF** = 0.00

MAX A Setting display projection for maximum value of input signal

- range of the setting is -99999...999999

- **DEF** = 100.00

SENSE Setting the tensionmeter sensitiveness [mV/V]

- range 1..4/2..8/4..16 mV/V
- fixed resolution in 4 decimal points
- menu is dynamic, the item is displayed only in automatic calibration

E.1 Setting the size of sections for projection

- range: 0.001/0.002/0.005/0.01/.../100

MAX.W. Setting the upper weighing limit

- range of the setting is -99999...999999

6.2.1c SETTING FIXED TARE

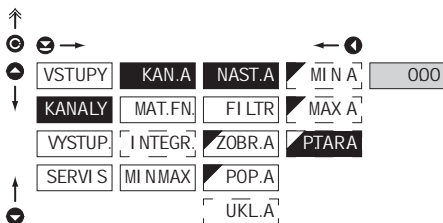

P.TAR.A Setting "Fixed tare" value

- setting is designed for the event when it is necessary to firmly shift the beginning of the range by known size

- when setting [P.TAR.A≠ 0] is in effect, display does not show the "T" symbol

- range of the setting: -99999...999999

- **DEF** = 0

6. SETTING PROFI

6.2.1d SELECTING WHERE TARE WILL BE APPLIED

Navigation icons: Up, Down, Left, Right, Home, and a button with a smiley face.

I NPUTS	CHAN.A	SET.A	MIN.A	CHAN.A	DEF
CHANNE.	MAT.FN	FI LTER	MAX.A	FI L.A	
OUTPUT	I NTEGR.	FORM.A	PTARA		
SERVI.C.	MI NMAX	DESC.A	TARED		
		LOG.A			

TARED Selecting the position of tare

- CHAN.A** The value will be tared before linearisation and digital filter
- FI L.A** The value will be tared after linearisation and digital filter

6.2.1e DIGITAL FILTERS

Navigation icons: Up, Down, Left, Right, Home, and a button with a smiley face.

I NPUTS	CHAN.A	SET.A	MOD.FA	NO	DEF
CHANNE.	MAT.FN	FI LTER	CON.F.A.	AVER.	
OUTPUT	I NTEGR.	FORM.A		FLOAT.	
SERVI.C.	MI NMAX	DESC.A		EXPON.	
		LOG.A		ROUND	

MOD.FA Selection of digital filters

- at times it is useful for better user projection of data on display to modify it mathematically and properly, wherefore the following filters may be used

- NO** Filters are off
- AVER.** Measured data average

- arithmetic average from given number [CON.F.A.] of measured values
- range 2..100

FLOAT. Selection of floating filter

- floating arithmetic average from given number [CON.F.A.] of measured data and updates with each measured value
- range 2..30

EXPON. Selection of exponential filter

- integration filter of first prvniho grade with time constant [CON.F.A.] measurement
- range 2..100

ROUND Measured value rounding

- is entered by any number, which determines the projection step [e.g. CON.F.A. = 2.5 > display 0, 2.5, 5,...]

CON.F.A. Setting constants

- this menu item is always displayed after selection of particular type of filter

DEF = 2

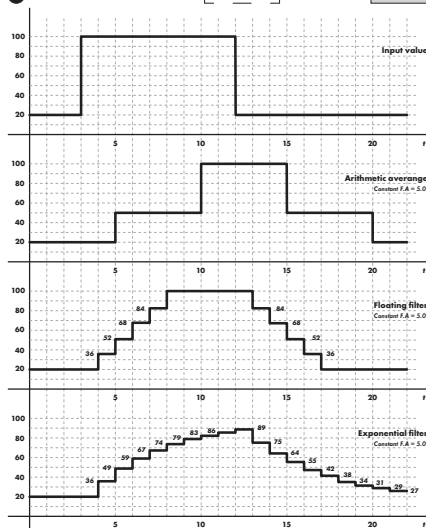

6.2.1f PROJECTION FORMAT - POSITIONING OF DECIMAL POINT

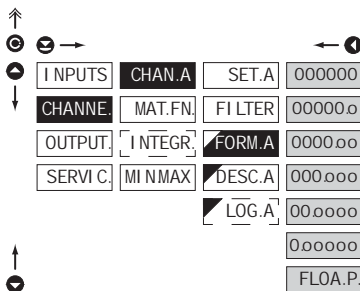

FORM.A Selection of decimal point

- the instrument allows for classic projection of a number with positioning of the DP as well as projection with floating DP, allowing to display a number in its most exact form. **FLOAT. P.**

000000. Setting DP - XXXXXX.

00000.0 Setting DP - XXXXX.x

0000.00 Setting DP - XXXX.xx

DEF

000.000 Setting DP - XXX.xxx

00.0000 Setting DP - XX.xxxx

0.00000 Setting DP - X.xxxxx

FLOA.P. Floating DP

6.2.1g PROJECTION OF DESCRIPTION - THE MEASURING UNITS

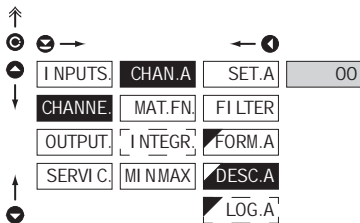

DESC.A Setting projection of descript. for "Channel A"

- projection of measured data may be extended (at the expense of the number of displayed places) by two characters for description
- description is set by shifted ASCII code, when two first places show the set description and two last characters their code in period 0...95
- description is cancelled by code 00

DEF = none

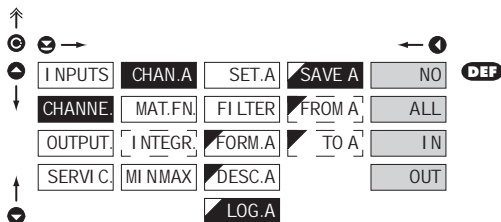

Table of signs on page 83

6. SETTING PROFI

6.2.1h

SELECTION OF STORING DATA INTO INSTRUMENT MEMORY



SAVE A

Selection of storing data into instrument memory

- by selection in this item you allow to register values into instrument memory
- another setting in item "OUTPUT. > MEMORY" (not in standard experiment)

NO

Measured data is not stored

ALL

Measured data is stored in memory

I N

Only data measured within the set interval is stored in memory

OUT

Only data measured outside the set interval is stored in memory

FROM A

Setting the initial interval value

- setting range: -99999...999999

TO A

Setting the final interval value

- setting range: -99999...999999

6.2.2a

MATHEMATIC FUNCTIONS

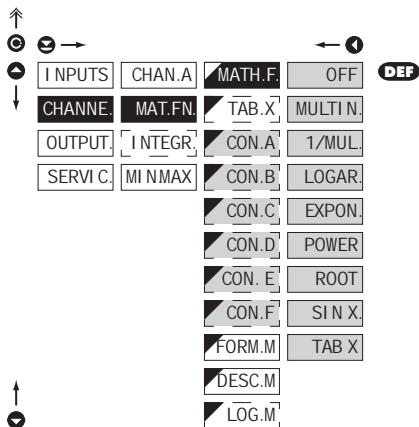

MATH.F.

Selection of mathematic functions

OFF

Mathematic functions are off

MULTI.N.

Multinomial

$$Ax^5 + Bx^4 + Cx^3 + Dx^2 + Ex + F$$

1/MUL.

 $1/x$

$$\frac{A}{x^5} + \frac{B}{x^4} + \frac{C}{x^3} + \frac{D}{x^2} + \frac{E}{x} + F$$

LOGAR.

Logarithm

$$A \times \ln\left(\frac{Bx + C}{Dx + E}\right) + F$$

EXPON.

Exponential

$$A \times e^{\left(\frac{Bx+C}{Dx+E}\right)} + F$$

POWER

Power

$$A \times (Bx + C)^{(Dx+E)} + F$$

ROOT

Root

$$A \times \sqrt{\frac{Bx + C}{Dx + E}} + F$$

SIN X

Sin x

$$A \sin^5 x + B \sin^4 x + C \sin^3 x + D \sin^2 x + E \sin x + F$$

TAB X

Switching on linearization table

- this menu can only be accessed in OM 502LX

CON.

Setting constants for calculation of mat.functions

- this menu is displayed only after selection of given mathematic function

6. SETTING PROFI

6.2.2b MATHEMATIC FUNCTIONS - SELECTION OF LINEARIZATION TABLE

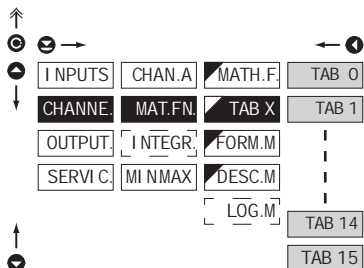
LX

TAB X Selection of linearization table

- this item is available only in type DM 502LX

TAB 0	Table number 0
TAB 1	Table number 1

TAB 14	Table number 14
TAB 15	Table number 15

6.2.2c MATHEMATIC FUNCTIONS - DECIMAL POINT

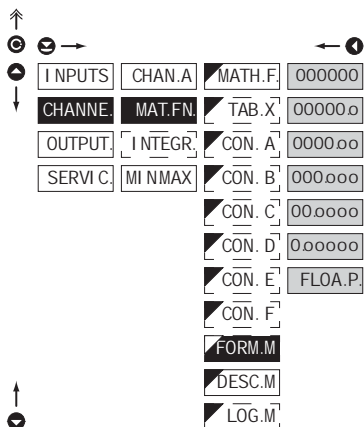

FORM.M. Selection of decimal point

- the instrument allows for classic projection of a number with positioning of the DP as well as projection with floating DP, allowing to display a number in its most exact form „FLOA.P.“

000000.	Setting DP - XXXXXX.
0000000	Setting DP - XXXXXx
00000000	Setting DP - XXXX.xx
000000000	Setting DP - XXX.xxx
0000000000	Setting DP - XX.xxxx
00000000000	Setting DP - X.xxxxx
FLOA.P.	Floating DP

- DEF

6.2.2d MATHEMATIC FUNCTIONS - MEASURING UNITS

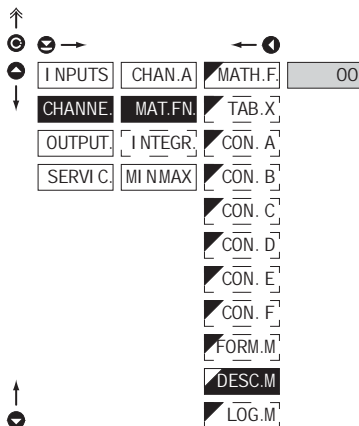
**DESC.M** Setting projection of description for "MAT.FN"

- projection of measured data may be extended (at the expense of the number of displayed places) by two characters for description
- description is set by shifted ASCII code, when two first places show the set description and two last characters their code in period 0...95
- description is cancelled by code 00

- **DEF** = no description



Table of signs on page 83

6.2.2e MATHEMATIC FUNCTIONS - SELECTION OF STORING DATA INTO INSTRUMENT MEMORY

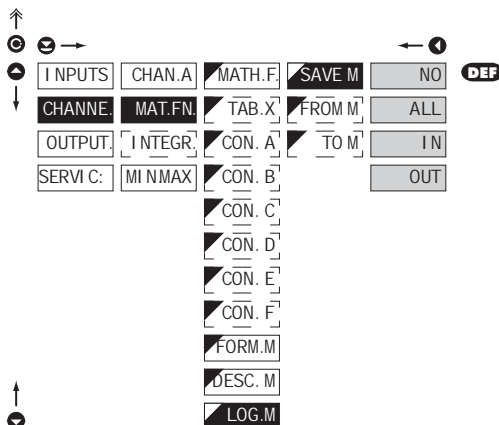
**LOG.M** Selection of storing data into instrument memory

- by selection in this item you allow to register values into instrument memory
- another setting in item "OUTPUT. > MEMORY" (not in standard experiment)

NO Measured data is not stored

ALL Measured data is stored in memory

IN Only data measured within the set interval is stored in memory

OUT Only data measured outside the set interval is stored in memory

FROM M Setting the initial interval value

- setting range: -99999...999999

TO M Setting the final interval value

- setting range: -99999...999999

6. SETTING PROFI

6.2.3a SELECTION OF INPUT QUANTITY FOR CALCULATION

The screenshot shows the 'INP.I' menu with the following options:

- ↑
- ☺ →
- ← ☹
- ↻
- ↑
- ↓
- ↑
- ↓

I NPUTS	CHAN.A	I N P . I	NO
CHANNE.	MAT.FN	SCALE	CHAN.A DEF
OUTPUT	I NTEGR.	DI VI D.	FI L.A
SERVI.C.	MI NMAX	UNSEN.	MAT.FN.
		SUBTR.	
		CLEAR	
		FORM.I	
		DESC.I	
		LOG.I	

I N P . I Selection of input quantity for calculation

- selecting value from which the integrated value will be calculated

NO	Evaluation of min/max value is off
CHAN.A	From "Channel A"
FI L.A	From "Channel A" after modification by dig.filter
MAT.FN.	From "Mathematic functions"



Primary setting of "Integrator" range is under "CHANNELS/SETTING A/MAX A, where maximum projection is set at time base 1 s

6.2.3b SETTING CALIBRATION CONSTANTS

The screenshot shows the 'SCALE' menu with the following options:

- ↑
- ☺ →
- ← ☹
- ↻
- ↑
- ↓
- ↑
- ↓

I NPUTS	CHAN.A	I N P . I
CHANNE.	MAT.FN	SCALE
OUTPUT	I NTEGR.	DI VI D.
SERVI.C.	MI NMAX	UNSEN.
		SUBTR.
		CLEAR
		FORM.I
		DESC.I
		LOG.I

SCALE Setting the multiplying constant

- through multiplying constant we may further mathematically adjust the data display projection
- range of the setting is 1..100 000
- **DEF** = 1

DI VI D. Setting the dividing constant

- through dividing constant we may further mathematically adjust the data display projection
- range: 1/10/60/100/1000/3600
- **DEF** = 1

6.2.3c SETTING THE "ZERO" BAND OF INSENSITIVENESS

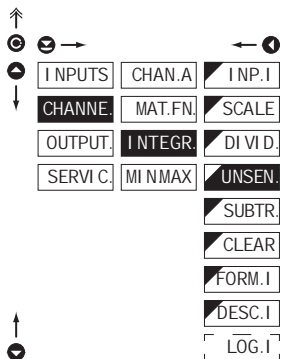
**UNSEN.** Setting the band of insensitivity

- by setting this item it is possible to extend "Zero" and thus achieve integration of the input signal from the set value
- range of the setting is 0...100 000

DEF = 0

6.2.3d SELECTION OF THE TYPE OF INTEGRATION

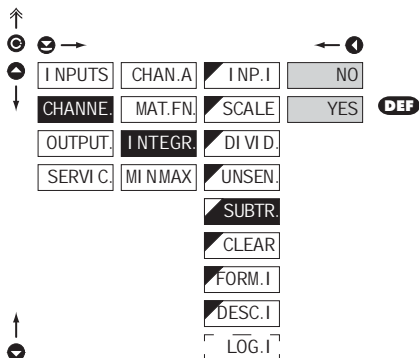
**SUBTR.** Selection of the type of integration

- the selection allows to suppress the negative value of input signal, i.e. the instrument integrates only in positive values (adds up)

NO Subtraction is off

YES Subtraction enabled

6. SETTING PROFI

6.2.3e SELECTION OF AUTOMATIC RESETTING

Navigation icons: ↑, Ⓞ, ☺, →, ←, Ⓚ, ↓, Ⓢ, Ⓣ

INPUTS	CHAN.A	INP.1	NO
CHANNE.	MAT.FN	SCALE	YES DEF
OUTPUT	INTEGR.	DI V D	
SERVIC.	MI NMAX	UNSEN.	
		SUBTR	
		CLEAR	
		FORM.1	
		DESC.1	
		LOG.1	

CLEAR Selection of automatic resetting

- in this step it is possible to allow automatic resetting upon display overflow

NO Automatic resetting is off

- upon display overflow error statement is displayed

YES Automatic resetting is enabled

- upon display overflow the instrument is automatically reset to zero and proceeds in continuous measuring

6.2.3f SELECTION OF PROJECTION FORMAT

Navigation icons: ↑, Ⓞ, ☺, →, ←, Ⓚ, ↓, Ⓢ, Ⓣ

INPUTS	CHAN.A	INP.1	000000
CHANNE.	MAT.FN	SCALE	00000.0 DEF
OUTPUT	INTEGR.	DI V D	0000.00
SERVIC.	MI NMAX	UNSEN.	000.000
		SUBTR	00.0000
		CLEAR	0.00000
		FORM.1	FLOA.P.
		DESC.1	
		LOG.1	

FORM.1 Selection of decimal point

- the instrument allows for classic projection of a number with positioning of the DP as well as projection with floating DP, allowing to display a number in its most exact form „FLOA.P.“

000000. Setting DP - XXXXXX.

00000.0 Setting DP - XXXXX.x

0000.00 Setting DP - XXXX.xx

000.000 Setting DP - XXX.xxx

00.0000 Setting DP - XX.xxxx

0.00000 Setting DP - X.xxxxx

FLOA.P. Floating DP

6.2.3g SELECTION OF PROJECTION OF MEASURING UNITS

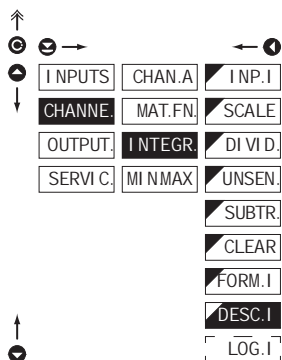
**DESC.I** Setting projection of description for INTEGR.

- projection of measured data may be extended (at the expense of the number of displayed places) by two characters for description
- description is set by shifted ASCII code, when two first places show the set description and two last characters their code in period 0...95
- description is cancelled by code 00

- **DEF** = no description

! Table of signs on page 83

6.2.3h SELECTION OF STORING DATA INTO INSTRUMENT MEMORY

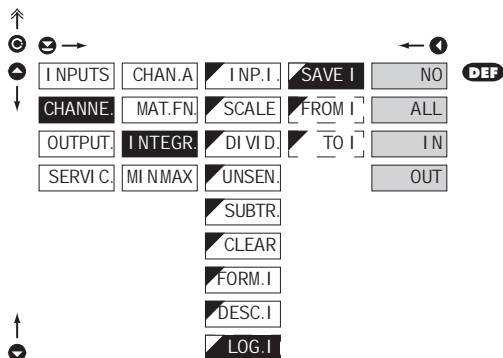
**LOG.I** Selection of storing data into instrument memory

- by selection in this item you allow to register values into instrument memory
- another setting in item "OUTPUT. > MEMORY" (not in standard experiment)

NO Measured data is not stored

ALL Measured data is stored in memory

IN Only data measured within the set interval is stored in memory

OUT Only data measured outside the set interval is stored in memory

FROM I Setting the initial interval value

- setting range: -99999...999999

TO I Setting the final interval value

- setting range: -99999...999999

6. SETTING PROFI

6.2.4 SELECTION OF EVALUATION OF MIN/MAX VALUE

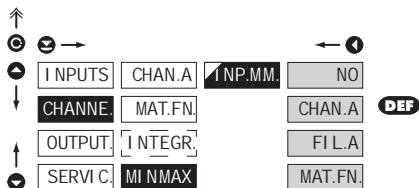

INP.MM. Selection of evaluation of min/max value

- selection of value from which the min/max value will be calculated

NO	Evaluation of min/max value is off
CHAN.A	From "Channel A"
FIL.A	From "Channel A" after digital filters processing
MAT.FN.	From "Mathematic functions"



6. SETTING PROFI

6.3 SETTING „PROFI“ - OUTPUTS

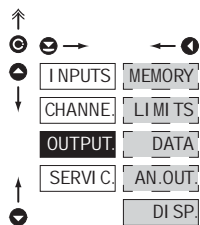

In this menu it is possible to set parameters of the instrument output signals

MEMORY	Setting data logging into memory
LIMITS	Setting type and parameters of limits
DATA	Setting type and parameters of data output
AN.OUT.	Setting type and parameters of analog output
DISP.	Setting display projection and brightness

6.3.1a SELECTION OF MODE OF DATA LOGGING INTO INSTRUMENT MEMORY

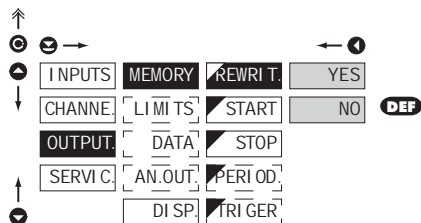

REWRITE Selection of the mode of data logging

- selection of the mode in the event of full instrument memory

NO	Rewriting values prohibited
YES	Rewriting values permitted, the oldest get rewritten by the latest

6.3.1b SETTING DATA LOGGING INTO INSTRUMENT MEMORY - RTC

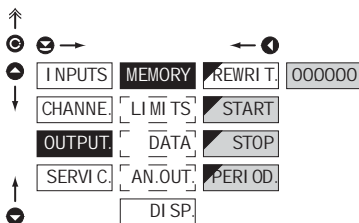
**START** Start of data logging into instrument memory

- time format HH:MM:SS

STOP Stop data logging into instrument memory

- time format HH:MM:SS

PERIOD Period of data logging into instrument memory

- determines the period in which values will be logged in an interval delimited by the time set under items **START** and **STOP**
- time format HH:MM:SS
- records are made on a daily basis in selected interval and period
- item not displayed if "SAVE" is selected in menu (INPUT > EXT. IN.)

RTC

The lowest recording rate possible is once a day, the highest is every second. Under exceptional circumstances it is possible to set the rate to 8 times per second by entering the recording period as 00:00:00. However, this mode is not recommended due to the memory overload. Recordings are realised in a timeframe of one day and are repeated periodically every following day. Recordings can take place either inside or outside of selected time intervals. The duration of re-writing can be determined by the number of channels recorded as well as by the recording rate.

6.3.1c SETTING DATA LOGGING INTO INSTRUMENT MEMORY - FAST

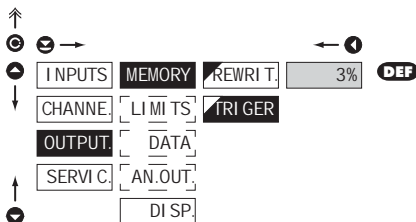
**TRIGGER** Setting logging data into inst. memory

- logging data into inst. memory is governed by the following selection, which determines how many percent of the memory is reserved for data logging prior to initiation of trigger impulse
- initialization is on ext. input or button
- setting in range 1...100 %
- when setting 100 %, datalogging works in the mode **ROLL** > data keep getting rewritten in cycles

1. Memory initialization

- clear memory (ext.input, button)
- LED "M" flashes, after reading **TRIGGER** [%] memory is permanently shining. In **ROLL** flashes constantly.

2. Triggering

- external input, button
- after the memory LED is full "M" turns off
- in the **ROLL** mode the trigger ends datalogging and LED turns off

3. Termination

- ext. input, button or reading data via RS

FAST

The memory operates on the basis of memory oscilloscope. Select an area of 0...100% of the memory capacity. [100% represents 8 192 individual recordings for a single channel measurement]. This area is filled cyclically up to the point when the recording starts (activated by the front panel button or by an external input). When the remaining memory capacity fills up the recording stops. A new recording is possible after the deletion of the latest recording. It is possible to abort a recording before its completion by reading out the data.

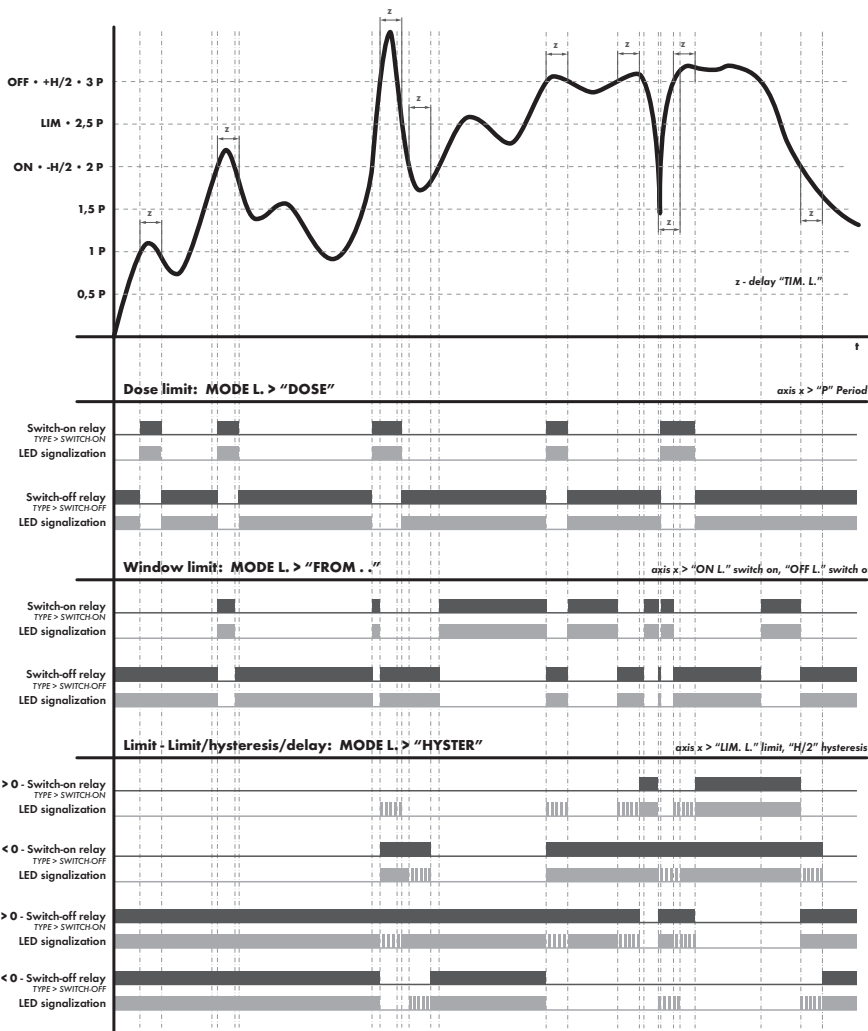

6.3.2a SELECTION OF INPUT FOR LIMITS EVALUATION

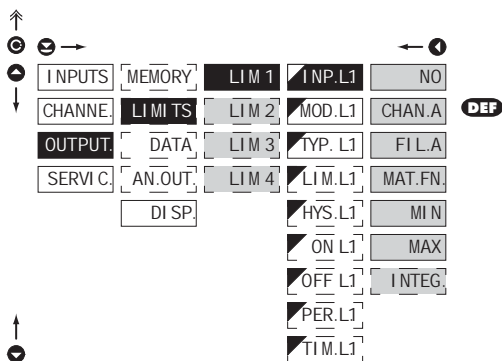

INP.L1 Selection evaluation of limits

- selection of value from which the limit will be evaluated

- NO** Limit evaluation is off
- CHAN.A** Limit evaluation from "Channel A"
- FIL.A** Limit evaluation from "Channel A" after digital filters processing
- MAT.FN.** Limit evaluation from "Mathematic functions"
- MIN** Limit evaluation from "Min. value"
- MAX** Limit evaluation from "Max. value"
- INTEG.** Limit evaluation from "Integrated value"

Setting is identical for LIM 1, LIM 2, LIM 3 and LIM 4

6.3.2b SELECTION OF TYPE OF LIMIT

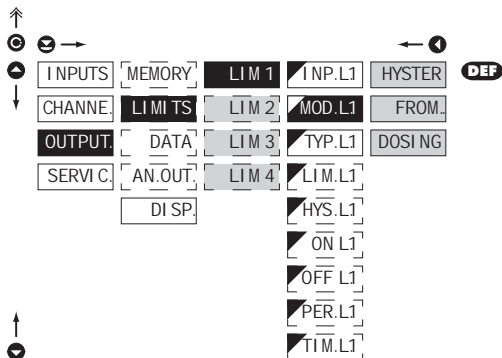

MOD.L1 Selection the type of limit

- HYSTER** Limit is in mode "Limit, hysteresis, delay"
- for this mode the parameters of "LIM.L1" are set, at which the limit will shall react, "HYS.L1" the hysteresis range around the limit (LIM $\pm 1/2$ HYS) and time "TIM.L1" determining the delay of relay switch-on
- FROM.** Frame limit
- for this mode the parameters are set for interval "ON.L1" the relay switch-on and "OFF.L1" the relay switch-off
- DOSING** Dose limit (periodic)
- for this mode the parameters are set for "PER.L1" determining the limit value as well as its multiples at which the output is active and "TIM.L2" indicating the time during which is the output active

Setting is identical for LIM 1, LIM 2, LIM 3 and LIM 4

6.3.2c SELECTION OF TYPE OF OUTPUT

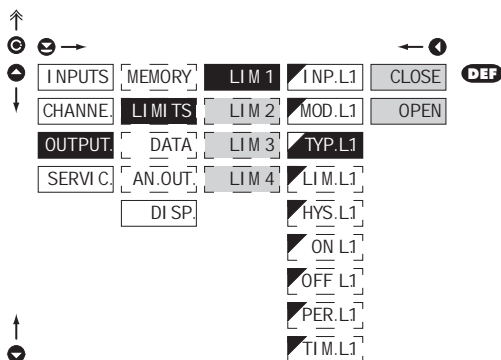

TYP.L1 Selection of type of output

CLOSE Output switches on when condition is met

OPEN Output switches off when condition is met

! Setting is identical for LIM 1, LIM 2, LIM 3 and LIM 4

6.3.2d SETTING VALUES FOR LIMITS EVALUATION

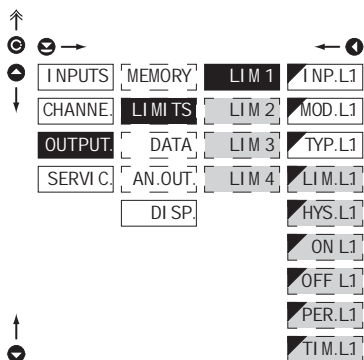

LIM.L1 Setting limit for switch-on

- for type "HYSTER"

HYS.L1 Setting hysteresis

- for type "HYSTER"
- indicates the range around the limit (in both directions, LIM. ±1/2 HYS.)

ON.L1 Setting the outset of the interval of limit switch-on

- for type "FROM.."

OFF.L1 Setting the end of the interval of limit switch-on

- for type "FROM.."

PER.L1 Setting the period of limit switch-on

- for type "DOSING"

TIM.L1 Setting the time switch-on of the limit

- for type "HYSTER" and "DOSING"
- setting within the range: ±0...99,9 s
- positive time > relay switches on after crossing the limit (LIM. L1) and the set time (TIM. L1)
- negative time > relay switches off after crossing the limit (LIM. L1) and the set negative time (TIM. L1)

! Setting is identical for LIM 1, LIM 2, LIM 3 and LIM 4

6.3.3a SELECTION OF DATA OUTPUT BAUD RATE

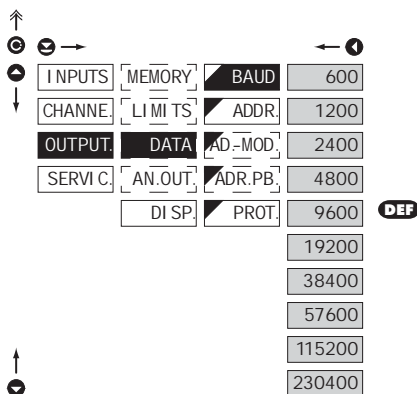

BAUD	Selection of data output baud rate
600	Rate - 600 Baud
1200	Rate - 1 200 Baud
2400	Rate - 2 400 Baud
4800	Rate - 4 800 Baud
9600	Rate - 9 600 Baud
19200	Rate - 19 200 Baud
38400	Rate - 38 400 Baud
57600	Rate - 57 600 Baud
115200	Rate - 115 200 Baud
230400	Rate - 230 400 Baud

6.3.3b SETTING INSTRUMENT ADDRESS

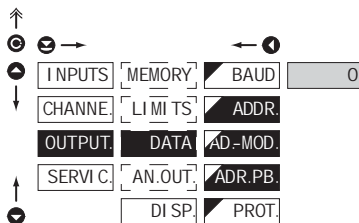

ADDR	Setting instrument address
	- setting in range 0...31
	- DEF = 00
AD - MOD	Setting instrument address - MODBUS
	- setting in range 1...247
	- DEF = 1
ADR_PB	Setting instrument address - PROFIBUS
	- setting in range 1...127
	- DEF = 19

6. SETTING PROFI

6.3.3c SELECTION OF DATA OUTPUT PROTOCOL

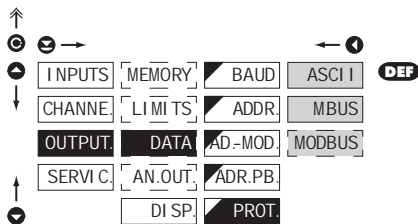

PROT. Selection of the type of analog output

ASCII Data protocol
ASCII

M.BUS Data protocol
DIN MessBus

MODBUS Data protocol
MODBUS-RTU

- option is available only for RS 485

6.3.4a SELECTION OF INPUT FOR ANALOG OUTPUT

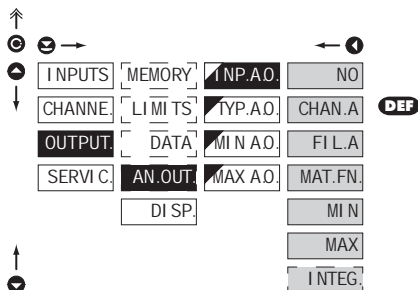

INP.A.O. Selection evaluation analog output

- selection of value from which the analog output will be evaluated

NO AD evaluation is off

CHAN.A AD evaluation from
"Channel A"

FIL.A AD evaluation from
"Channel A" after digital
filters processing

MAT.FN. AD evaluation from "Math.
functions"

MIN AD evaluation from "Min.
value"

MAX AD evaluation from "Max.
value"

INTEG. AD evaluation
from "Integrated value"

6.3.4b SELECTION OF THE TYPE OF ANALOG OUTPUT

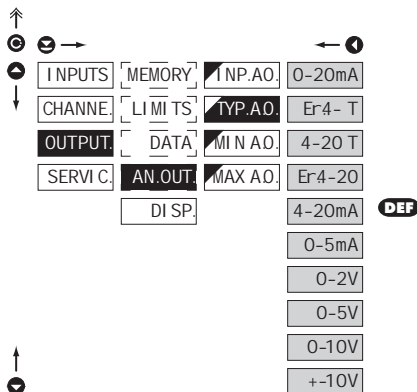

TYP. A.O. Selection of the type of analog output

0-20mA Type - 0...20 mA

Er4- T Type - 4...20 mA with indication

- with broken loop detection and indication of error statement (< 3,6 mA)

4-20 T Type - 4...20 mA with indication

- with broken loop detection (< 3,6 mA)

Er4-20 Type - 4...20 mA with indication

- with indic. of error statement (< 3,6 mA)

4-20mA Type - 4...20 mA

0-5mA Type - 0...5 mA

0-2V Type - 0...2 V

0-5V Type - 0...5 V

0-10V Type - 0...10 V

+10V Type - ±10 V

6.3.4c SETTING THE ANALOG OUTPUT RANGE

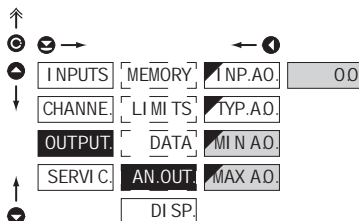

AN. OUT. Setting the analog output range

- analog output is isolated and its value corresponds with displayed data. It is fully programmable, i.e. it allows to assign the AO limit points to two arbitrary points of the entire measuring range

MIN.A.O. Assigning the display value to the beginning of the AO range

- range of the setting: -99999...999999

- **DEF** = 0

MAX.A.O. Assigning the display value to the end of the AO range

- range of the setting: -99999...999999

- **DEF** = 100

6. SETTING PROFI

6.3.5a SELECTION OF INPUT FOR DISPLAY PROJECTION

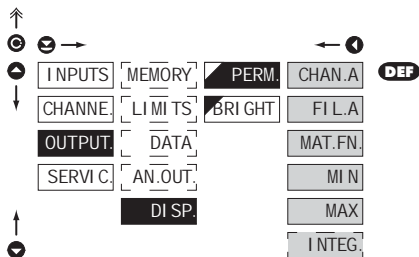

PERM. Selection display projection

- selection of value which will be shown on the instrument display

CHAN.A	Projection of values from "Channel A"
FI L A	Projection of values from "Channel A" after digital filters processing
MAT.FN.	Projection of values from "Math.functions"
MI N.	Projection of values from "Min.value"
MAX	Projection of values from "Max. value"
INTEG.	Projection of values from "Integrated value"

6.3.5b SELECTION OF DISPLAY BRIGHTNESS

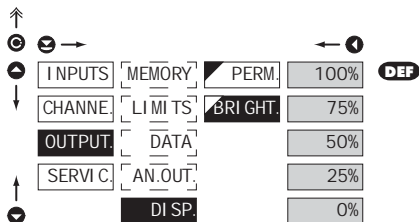

BRI GHT Selection of display brightness

- by selecting display brightness we may appropriately react to light conditions in place of instrument location

0%	Display is off
25%	Display brightness - 25%
50%	Display brightness - 50%
75%	Display brightness - 75%
100%	Display brightness - 100%



6. SETTING PROFI

6.4 SETTING "PROFI" - SERVIS

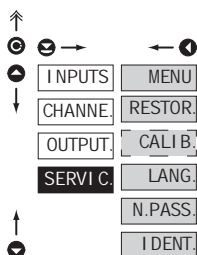

The instrument service functions are set in this menu

MENU	Selection of menu type LIGHT/PROFI
RESTOR.	Restore instrument manufacture setting and calibration
CALI B	Input range calibration for „DU“ version
LANG.	Language version of instrument menu
N.PASS.	Setting new access password
I DENT.	Instrument identification

6.4.1 SELECTION OF TYPE OF PROGRAMMING MENU

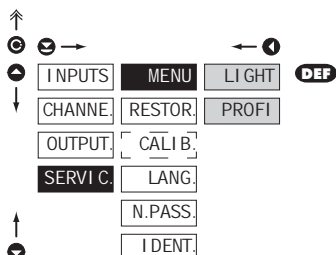

MENU Selection of menu type - LIGHT/PROFI

- enables setting the menu complexity according to user needs and skills

LI GHT Active LIGHT menu

- simple programming menu, contains only items necessary for configuration and instrument setting
- linear menu > items one after another

PROFI Active PROFI menu

- complete programming menu for expert users
- free menu



Change of setting is valid upon next access into menu

6.4.2 RESTORATION OF MANUFACTURE SETTING

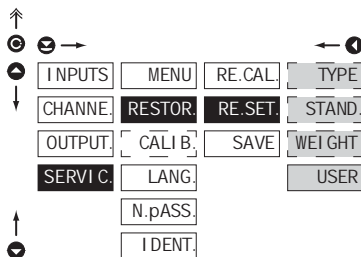
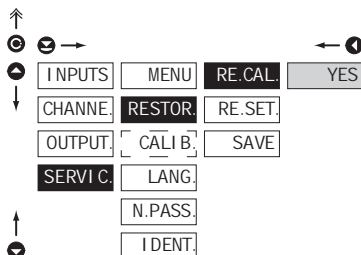
**RESTOR.** Restoration of manufacture setting

- in the event of error setting or calibration, manufacture setting may be restored.

RE.CAL. Restoration of manufacture calibration of the instrument

- prior executing the changes you will be asked to confirm you selection ,YES'

RE.SET. Restoration of instrument manufacture setting

TYPE Restoration of instrument manufacture setting

- generating the manufacture setting for currently selected type of instrument (items marked DEF)

STAND. Restoration of instrument manufacture setting

- generating the manufacture setting for currently selected type of instrument (items marked DEF, only for DM 502T)

WEIGHT Restoration of instrument manufacture setting

- generating the manufacture setting for currently selected type of instrument (items marked DEF, only for DM 502T)

USER Restoration of instrument user setting

- generating the instrument user setting, i.e. setting stored under **SERVIC./RESTOR./SAVE**

SAVE Save instrument user setting

- storing the user setting allows the operator to restore it in future if needed



After restoration the instrument switches off for couple seconds

JOBS PERFORMED	RESTORE	
	CALIBRATION	SETTING
cancel USER menu rights	✓	✓
deletes table of items order in USER - LIGHT menu	✓	✓
adds items from manufacture to LIGHT menu	✓	✓
deletes data stored in FLASH	✓	✓
cancel or linearization tables	✓	✓
clears tare	✓	✓
restore manufacture calibration	✓	✗
restore manufacture setting	✗	✓

6. SETTING PROFI

6.4.3 CALIBRATION - INPUT RANGE

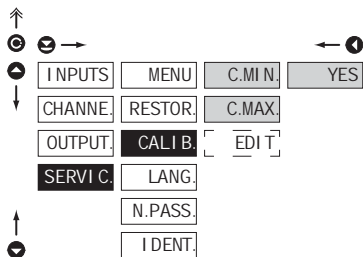

! After incorrect client calibration it is always possible to restore manufacture calibration ('SERVIC/RESTOR/CALIB.')

CALI B. Input range calibration

- prior performing any changes you will be asked to confirm your selection "YES"

C. MI N Calibration of the beginning of the measuring range

- prior confirmation of the selection the reference signal has to be connected

C. MAX Calibration of the end of the measuring range

- prior confirmation of the selection the reference signal has to be connected

! Manual calibration

MAX Sensor range

SENSE Sensor sensitivity

Automatic calibration

[after calibration in menu "SERVIS/KALIB."]

MIN Size of load with which minimum calibration was performed

MAX Size of load with which maximum calibration was performed

- upon maximum calibration we recommend the reference load value in the upper third of the measuring range

6.4.4 CALIBRATION - MODIFICATION OF INTERNAL CONSTANTS

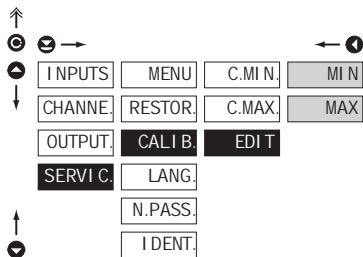

EDI T Modification of internal calibration constants

- this option is designed solely for contingent metrological examination and protocol
- item is available after aut. calibration

MI N Minimum calibration range

- range: ±99.0000

MAX Maximum calibration range

- range: ±99.0000

6.4.5 SELECTION OF INSTRUMENT MENU LANGUAGE VERSION

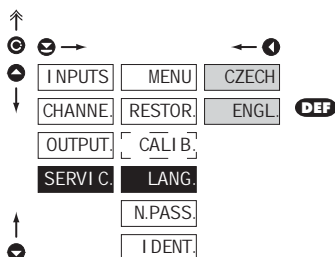
**LANG.** Selection of instrument menu language version

CZECH	Instrument menu is in Czech
ENGL.	Instrument menu is in English

6.4.6 SETTING NEW ACCESS PASSWORD

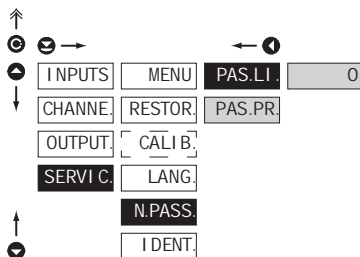
**N.PASS.** Setting new password for access to LIGHT and PROFi menu

- this option allows to change the numeric code, which blocks the access into **LIGHT** and **PROFI** menu.
- numerical code range: 0...9999
- universal passwords in the event of loss:
LIGHT Menu > „8177”
PROFI Menu > „7915”

6.4.7 INSTRUMENT IDENTIFICATION

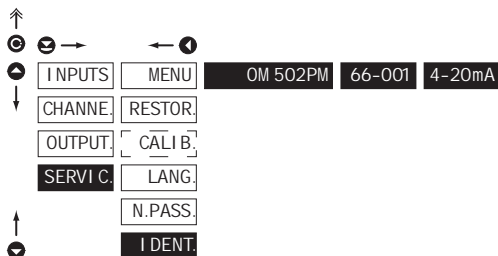
**I.DENT.** Projection of instrument SW version

- display shows type identification of the instrument, SW number, SW version and current input setting [Mode]
- if the SW version reads a letter on first position, it is a customer SW

I.DENT.	Pos.	Description
	1.	type of instrument
	2.	SW: number - version
	3.	the input type



SETTING USER

For user operation

Menu items are set by the user (Profi/Light) as per request

Access is not password protected

Optional menu structure either tree (PROFI) or linear (LIGHT)

7.0 SETTING ITEMS INTO "USER" MENU

- **USER** menu is designed for users who need to change only several items of the setting without the option to change the primary instrument setting (e.g. repeated change of limit setting)
- there are no items from manufacture permitted in **USER** menu
- on items indicated by inverse triangle  LIM 1
- setting may be performed in **LIGHT** or **PROFI** menu, with the **USER** menu then overtaking the given menu structure

Setting



NO

item will not be displayed in USER menu

YES

item will be displayed in USER menu with editing option

SHOW

item will be solely displayed in USER menu

Setting sequence of items in "USER" menu

In compiling USER menu from active LIGHT menu the items (max. 10) may be assigned a sequence, in which they will be projected in the menu

setting projection sequence



Example of ranking the order of menu items in the "USER" menu

In this example we want to have a direct access to menu items Limit 1 and Limit 2 (example show is for the Light menu, but can equally be used in the Profi menu).

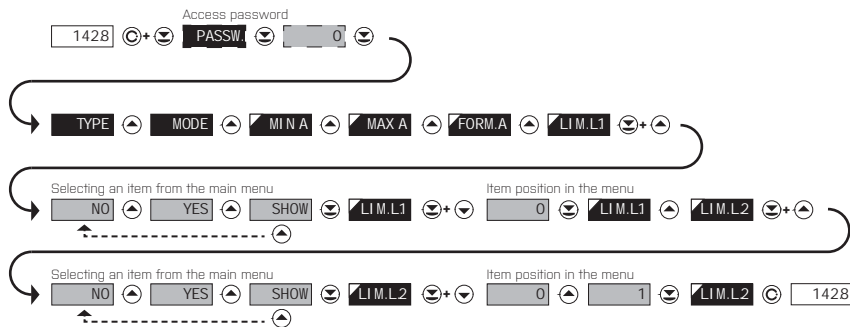

The result of this setting is that when the **OK** button is pressed, the display will read „LIM.L1“. By pressing **ENTER** button you confirm your selection and then you can set the desired limit value, or by pressing the **ESC** button you can go to setting of „LIM.L2“ where you can proceed identically as with Limit one.

You can exit the setting by pressing the **ESC** button by which you store the latest setting and pressing the **OK** button will take you back to the measuring mode

8. DATA PROTOCOL



The instruments communicate via serial line RS232 or RS485. For communication they use the ASCII protocol. Communication runs in the following format:

ASCII: 8 bit, no parity, one stop bit

DIN MessBus: 7 bit, even parity, one stop bit

The transfer rate is adjustable in the instrument menu. The instrument address is set in the instrument menu in the range of 0 ÷ 31. The manufacture setting always presets the ASCII protocol, rate of 9600 Baud, address 00. The type of line used - RS232 / RS485 - is determined by an output board automatically identified by the instrument.

The commands are described in specifications you can find at www.orbit.merret.cz

DETAILED DESCRIPTION OF COMMUNICATION VIA SERIAL LINE

EVENT	TYPE	PROTOCOL	TRANSMITTED DATA	
Data solicitation (PC)	232	ASCII	# A A A <CR>	
		MessBus	No - data is transmitted permanently	
	485	ASCII	# A A A <CR>	
		MessBus	<SADR> <ENQ>	
Data transmission (instrument)	232	ASCII	> D (D) (D) (D) (D) (D) (D) (D) (D) (D) (D) (D) (D) (D) <CR>	
		MessBus	<STX> D (D) (D) (D) (D) (D) (D) (D) (D) (D) (D) (D) (D) (D) <ETX> <BCC>	
	485	ASCII	> D (D) (D) (D) (D) (D) (D) (D) (D) (D) (D) (D) (D) (D) <CR>	
		MessBus	<STX> D (D) (D) (D) (D) (D) (D) (D) (D) (D) (D) (D) (D) (D) <ETX> <BCC>	
Confirmation of data acceptance (PC) - OK	485	MessBus	<DLE> 1	
Confirmation of data acceptance (PC) - Bad			<NAK>	
Sending address (PC) prior command			<EADR> <ENQ>	
Confirmation of address (instrument)			<SADR> <ENQ>	
Command transmission (PC)	232	ASCII	# A A N P (D) (D) (D) (D) (D) (D) (D) (D) (D) <CR>	
		MessBus	<STX> S N P (D) (D) (D) (D) (D) (D) (D) (D) (D) (D) <ETX> <BCC>	
	485	ASCII	# A A N P (D) (D) (D) (D) (D) (D) (D) (D) (D) (D) <CR>	
		MessBus	<STX> S N P (D) (D) (D) (D) (D) (D) (D) (D) (D) (D) <ETX> <BCC>	
Command confirmation (instrument)	232	ASCII	OK	! A A <CR>
			Bad	? A A <CR>
		Messbus		No - data is transmitted permanently
		485	ASCII	OK
	Bad			? A A <CR>
	MessBus		OK	<DLE> 1
			Bad	<NAK>
	Instrument identification			# A A 1 Y <CR>
HW identification			# A A 1 Z <CR>	
One-time transmission			# A A 7 X <CR>	
Repeated transmission			# A A 8 X <CR>	

LEGEND

SIGN	RANGE	DESCRIPTION
#	35 23 _H	Command beginning
A A	0...31	Two characters of instrument address (sent in ASCII - tens and units, e.g. "01", "99" universal)
<CR>	13 00 _H	Carriage return
<SP>	32 20 _H	Space
N, P		Number and command - command code
D		Data - usually characters "0"... "9", "*", ".", ";", ":", "[] - dp, and {} may prolong data
R	30 _H ...3F _H	Relay and tare status
!	33 21 _H	Positive confirmation of command (ok)
?	63 3F _H	Negative confirmation of command (point)
>	62 3E _H	Beginning of transmitted data
<STX>	2 02 _H	Beginning of text
<ETX>	3 03 _H	End of text
<SADR>	adresa +60 _H	Prompt to send from address
<EADR>	adresa +40 _H	Prompt to accept command at address
<ENQ>	5 05 _H	Terminate address
<DLE>1	16 49 10 _H 31 _H	Confirm correct statement
<NAK>	21 15 _H	Confirm error statement
<BCC>		Check sum -XOR

RELAY, TARE

SIGN	RELAY 1	RELAY 2	TARE	CHANGE RELAY 3/4
P	0	0	0	0
Q	1	0	0	0
R	0	1	0	0
S	1	1	0	0
T	0	0	1	0
U	1	0	1	0
V	0	1	1	0
W	1	1	1	0
p	0	0	0	1
q	1	0	0	1
r	0	1	0	1
s	1	1	0	1
t	0	0	1	1
u	1	0	1	1
v	0	1	1	1
w	1	1	1	1

Relay status is generated by command #AA6X <CR>.

The instrument immediately returns the value in the format >HH <CR>, where HH is value in HEX format and range 00_H...FF_H. The lowest bit stands for „Relay 1“, the highest for „Relay 8“

9. ERROR STATEMENTS



ERROR	CAUSE	ELIMINATION
E.D.Un.	Number is too small (large negative) to be displayed	change DP setting, channel constant setting
E.D.Ow.	Number is too large to be displayed	change DP setting, channel constant setting
E.T.UN.	Number is outside the table range	increase table values, change input setting (channel constant setting)
E.T.Ow.	Number is outside the table range	increase table values, change input setting (channel constant setting)
E.I .UN.	Input quantity is smaller than permitted input quantity range	change input signal value or input (range) setting
E.I .Ow.	Input quantity is larger than permitted input quantity range	change input signal value or input (range) setting
E.Hw.	A part of the instrument does not work properly	send the instrument for repair
E.EE	Data in EEPROM corrupted	perform restoration of manufacture setting, upon repeated error statement send instrument for repair
E.SET.	Data in EEPROM outside the range	perform restoration of manufacture setting, upon repeated error statement send instrument for repair
E.CLR	Memory was empty (presetting carried out)	upon repeated error statement send instrument for repair, possible failure in calibration
E.OUT.	Analogue output current loop disconnected	check wire connection

The instrument allows to add two descriptive characters to the classic numeric formats (at the expense of the number of displayed places). The setting is performed by means of a shifted ASCII code. Upon modification the first two places display the entered characters and the last two places the code of the relevant symbol from 0 to 95. Numeric value of given character equals the sum of the numbers on both axes of the table.

Description is cancelled by entering characters with code 00

	0	1	2	3	4	5	6	7		0	1	2	3	4	5	6	7
0		7	"	#	\$	%	&	'	0	!	"	#	\$	%	&	'	
8	:	;	*	+	,	-	.	/	8	()	*	+	,	-	.	/
16	0	1	2	3	4	5	6	7	16	0	1	2	3	4	5	6	7
24	8	9	VA	Vr	<	=	>	?	24	8	9	VA	Vr	<	=	>	?
32	P	Q	R	S	T	U	V	W	32	@	A	B	C	D	E	F	G
40	H	I	J	K	L	M	N	O	40	H	I	J	K	L	M	N	O
48	P	Q	R	S	T	U	V	W	48	P	Q	R	S	T	U	V	W
56	X	Y	Z	[\]	^	_	56	X	Y	Z	[\]	^	_
64	`	a	b	c	d	e	f	g	64	`	a	b	c	d	e	f	g
72	h	i	j	k	l	m	n	o	72	h	i	j	k	l	m	n	o
80	p	q	r	s	t	u	v	w	80	p	q	r	s	t	u	v	w
88	x	y	z	{		}	~		88	x	y	z	{		}	~	

11. TECHNICAL DATA



INPUT

range is fixed, as per order

Range:	±99,999 mV	>1,8 MΩ
	±999,99 mV	1,8 MΩ
	±9,9999 V	1,8 MΩ
	±99,999 V	1,8 MΩ
	±300,00 V	1,8 MΩ
	±999,99 µA	< 300 mV
	±9,9999 mA	< 300 mV
	±99,999 mA	< 300 mV
	±999,99 mA	< 50 mV
	±5,0000 A	< 10 mV

Range:	0...5 mA	< 300 mV
	0...20 mA	< 300 mV
	4...20 mA	< 300 mV
	±2 V	1,8 MΩ
	±5 V	1,8 MΩ
	±10 V	1,8 MΩ
	±40 V	1 MΩ

Number of inputs: 2, [Input U and Input I]

Range:	0...5 mA	< 300 mV
	0...20 mA	< 300 mV
	4...20 mA	< 300 mV
	±2 V	1,8 MΩ
	±5 V	1,8 MΩ
	±10 V	1,8 MΩ
	±40 V	1 MΩ

Number of inputs: 2, [Input U and Input I]

Time base: 1 s

Zobrazení: immediate [±99999]
accrued [999999]

Range:	0...5 mA	< 300 mV
	0...20 mA	< 300 mV
	4...20 mA	< 300 mV
	±2 V	1,8 MΩ
	±5 V	1,8 MΩ
	±10 V	1,8 MΩ
	±40 V	1 MΩ

Number of inputs: 2, [Input U and Input I]

Linearization: linear interpolation in 256 points

Number of tables: 16

Voltage of lin. pot. 2,5 VDC/6 mA
min. potentiometer resistance is 500 Ω

DC

Input U
Input U
Input U
Input U
Input U

Input I
Input I
Input I
Input I
Input I

PM

Input I
Input I
Input I
Input U
Input U
Input U

I

Input I
Input I
Input I
Input U
Input U
Input U
Input U

I

Input I
Input I
Input I
Input U
Input U
Input U
Input U

DU

range is fixed, as per order

Sensitiveness: 1..4 mV/V
2...8 mV/V
4...16 mV/V

Connection: 4/6-wire

Tensiometer volt.: 10 VDC, max. load 65 Ω

PROJECTION

Display: 999999, intensive red or green
14-ti segment LED, digit height 14mm

Projection: ±99999 [-99999...999999]

Decimal point: adjustable - in menu

Brightness: adjustable - in menu

INSTRUMENT ACCURACY

TC: 50 ppm/°C

Accuracy: ±0,02% of range + 1 digit

±0,05% of range + 1 digit

Above accuracies apply for projection 99999

Rate: 0,1...100 measurements/s

Overload capacity: 10x [t < 100 ms] not for 500 V and 5 A,

2x [long-term]

Linearisation: by linear interpolation in 50 points

- solely via QM Link

Digital filters: Averaging, Floating average, Exponential filter,
Rounding

Functions: Tare - display resetting

Hold - stop measuring [at contact]

Lock - control key locking

MM - min/max value

Mathematic functions

QM Link: company communication interface for setting,
operation and update of instrument SW

Watch-dog: reset after 400 ms

Calibration: at 25°C and 40% of r.h.

COMPARATOR

Type: digital, adjustable in menu

Mode: Hysteresis, From, Dosing

Limits: -99999...999999

Hysteresis: 0...999999

Delay: 0...99,9 s

Outputs: 2x relays with switch-on contact [Form A]
[230 VAC/30 VDC, 3 A]*

2x relays with switch-off contact [Form C]

[230 VAC/50 VDC, 3 A]*

2x SSR [250 VAC/ 1 A]*

2x/4x open collector [30 VDC/100 mA]

2x bistabil relays [250 VAC/250 VDC, 3 A/0,3 A]*

Relay: 1/8 HP 277 VAC, 1/10 HP 125 V, Pilot Duty D300

T

DU, T

* values apply for resistance load

DATA OUTPUTS

Protocols:	ASCII, DIN MessBus, MODBUS, PROBUS
Data format:	8 bit + no parity + 1 stop bit (ASCII) 7 bit + even parity + 1 stop bit (MessBus)
Rate:	600...230 400 Baud 9 600 Baud...12 Mbaud (PROFIBUS)
RS 232:	isolated, two-way communication
RS 485:	isolated, two-way communication, addressing [max. 31 instruments]
PROFIBUS	Data protocol SIEMENS

ANALOG OUTPUTS

Type:	isolated, programmable with 12 bits Q/A converter, analog output corresponds with displayed data, type and range are adjustable
Non-linearity:	0,1% of range
TC:	15 ppm/°C
Rate:	response to change of value < 1 ms
Voltage:	0...2 V/5 V/10 V/±10 V
Current:	0...5/20 mA/4...20 mA - compensation of conduct to 500 Ω/12 V or 1 000 Ω/24 V

MEASURED DATA RECORD

Type RTC:	time-controlled logging of measured data into instrument memory, allows to log up to 250 000 values
Type FAST:	fast data logging into instrument memory, allows to log up to 8 000 values at a rate of 40 records/s
Transmission:	via data output RS 232/485 or via QM Link

EXCITATION

Adjustable:	5...24 VDC/max. 12 W, isolated
Fixed:	10 VDC, maximal load is 65 Ω

T**POWER SUPPLY**

Options:	10...30 V AC/DC, 10 VA, PF ≥ 0,4, isolated, - fuse inside [T 4000 mA] 80...250 V AC/DC, 10 VA, PF ≥ 0,4, isolated - fuse inside [T 630 mA]
----------	---

MECHANIC PROPERTIES

Material:	Noryl GFN2 SE1, incombustible UL 94 V-1
Dimensions:	96 x 48 x 120 mm
Panel cut-out:	90,5 x 45 mm

OPERATING CONDITIONS

Connection:	connector terminal board, conductor cross-section <1,5 mm² / <2,5 mm²
Stabilisation period:	within 15 minutes after switch-on
Working temp.:	0°...60°C
Storage temp.:	-10°...85°C
Cover:	IP65 [front panel only]
Construction:	safety class I
Dielectric strength:	4 kVAC after 1 min between supply and input 4 kVAC after 1 min between supply and data/ analog output 4 kVAC after 1 min between supply and relay output 2,5 kVAC after 1 min between supply and data/ analog output
Overvoltage cat.:	EN 61010-1, A2
Insulation resist.:	for pollution degree II, measurement cat. III instrum.power supply > 670 V [PI], 300 V [DI] Input/output > 300 V [PI], 150 [DI]
EMC:	EN 61326-1

12. INSTRUMENT DIMENSIONS AND INSTALLATION



Front view



Panel cut

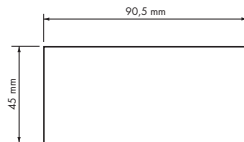

Side view

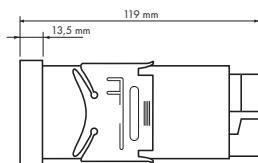

Panel thickness: 0,5...20 mm

INSTRUMENT INSTALLATION

1. insert the instrument into the panel cut-out
2. fit both travellers on the box
3. press the travellers close to the panel

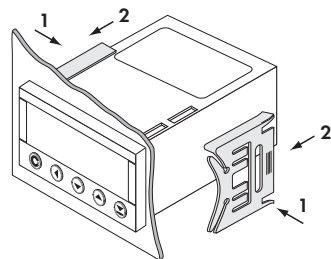
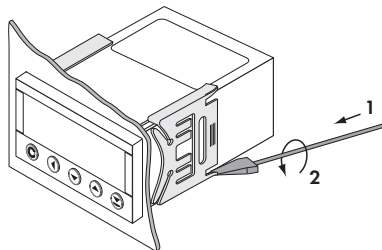

INSTRUMENT DISASSEMBLY

1. slide a screw driver under the traveller wing
2. turn the screw driver and remove the traveller
3. take the instrument out of the panel



Product **OM 502** **DC PM I LX DU T**
Type
Manufacturing No.
Date of sale

GUARANTEE

A guarantee period of 60 months from the date of sale to the user applies to this instrument.
Defects occurring during this period due to manufacture error or due to material faults shall be eliminated free of charge.

For quality, function and construction of the instrument the guarantee shall apply provided that the instrument was connected and used in compliance with the instructions for use.

The guarantee shall not apply to defects caused by:

- mechanic damage
- transportation
- intervention of unqualified person incl. the user
- unavoidable event
- other unprofessional interventions

The manufacturer performs guarantee and post.guarantee repairs unless provided for otherwise.

YEARS

Stamp, signature



Company: **ORBIT MERRET, spol. s r.o.**
Klánova 81/141, 142 00 Prague 4, Czech Republic, IDNo.: 00551309

Manufactured: **ORBIT MERRET, spol. s r.o.**
Vodňanská 675/30, 198 00 Prague 9, Czech Republic

declares at its explicit responsibility that the product presented hereunder meets all technical requirements, is safe for use when utilised under the terms and conditions determined by ORBIT MERRET, spol.s r.o. and that our company has taken all measures to ensure conformity of all products of the types referred-to hereunder, which are being brought out to the market, with technical documentation and requirements of the appurtenant Czech statutory orders.

Product: Programmable panel instrument

Type: **DM 502**

Version: DC, PM, I, LX, DU, T

That has been designed and manufactured in line with requirements of:

Statutory order no. 17/2003 Coll., on low-voltage electrical equipment (directive no. 73/23/EHS)
Statutory order no. 616/2006 Coll., on electromagnetic compatibility (directive no. 2004/108/EHS)

The product qualities are in conformity with harmonized standard:

el. bezpečnost: EN 61010-1
EMC: EN 61326-1
Electronic measuring, control and laboratory devices – Requirements for EMC "Industrial use"
EN 50131-1, chap. 14 and chap. 15, EN 50130-4, chap. 7, EN 50130-4, chap. 8 [EN 61000-4-11, ed. 2], EN 50130-4, chap. 9 [EN 61000-4-2], EN 50130-4, chap. 10 [EN 61000-4-3, ed. 2], EN 50130-4, chap. 11 [EN 61000-4-6], EN 50130-4, chap. 12 [EN 61000-4-4, ed. 2], EN 50130-4, chap. 13 [EN 61000-4-5], EN 61000-4-8, EN 61000-4-9, EN 61000-6-1, EN 61000-6-2, EN 55022, kap. 5 a kap. 6

The product is furnished with CE label issued in 2007.

As documentation serve the protocols of authorized and accredited organizations:

EMC MO CR, Testing institute of technical devices, protocol no. 80/6-330/2006 of 15/01/2007
MO CR, Testing institute of technical devices, protocol no. EMI.80/6-333/2006 of 15/01/2007

Place and date of issue: Prague, 19. Juli 2009

Miroslav Hackl
Company representative

Assessment of conformity pursuant to §22 of Act no. 22/1997 Coll. and changes as amended by Act no.71/2000 Coll. and 205/2002 Coll