

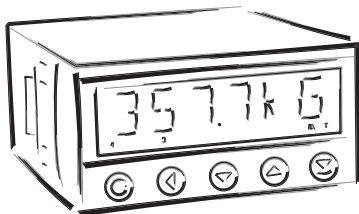

OM 502

5 DIGIT PROGRAMMABLE INSTRUMENT

DC VOLTMETER/AMMETER
PROCESS MONITOR
INTEGRATOR
LINEARIZATOR
DISPLAYS FOR LIN. POTENTIOMETERS
DISPLAY INST. FOR TENSIO METER



SAFETY INSTRUCTIONS

Please, read the enclosed safety instructions carefully and observe them!
These instruments should be safeguarded by isolated or common fuses (breakers)!
For safety information the EN 61 010-1 + A2 standard must be observed.
This instrument is not explosion-safe!

TECHNICAL DATA

Measuring instruments of the OM 502 series conform to the European regulation 89/336/EWG.

The instruments are up to the following European standards:

EN 55 022, class B

EN 61000-4-2, -4, -5, -6, -8, -9, -10, -11

The instruments are applicable for unlimited use in agricultural and industrial areas.

CONNECTION

Supply of energy from the main line has to be isolated from the measuring leads.



ORBIT MERRET, spol. s r.o.

Vodnanská 675/30
198 00 Prague 9
Czech Republic

Tel: +420 - 281 040 200
Fax: +420 - 281 040 299
e-mail: orbit@merret.cz
www.orbit.merret.cz



1.	Contents	3
2.	Instrument description	4
3.	Instrument connection	6
4.	Instrument setting	8
	Symbols used in the instructions	10
	Setting the DP and the (-) sign	10
	Control keys function	11
	Setting/permitting items into "USER" menu	11
5.	Setting "LIGHT" menu	12
5.0	Description "LIGHT" menu	12
	"LIGHT" menu input	14
	Setting input - Type "DC"	16
	Setting input - Type "PM"	18
	Setting input - Type "I"	20
	Setting input - Type "IX"	22
	Setting input - Type "DU"	24
	Setting input - Type "T"	26
	Setting Limits	28
	Setting analog output	30
	Selection of programming menu „LIGHT"/„PROFI"	32
	Restoration of manufacture setting	32
	Automatic calibration - input range	33
	Selection of instrument menu language version	34
	Setting new access password	34
	Instrument identification	35
6.	Setting "PROFI" menu	36
6.0	Description of "PROFI" menu	36
6.1	"PROFI" menu - INPUTS	
6.1.1	Resetting internal values	38
6.1.2	Setting measuring type, range, mode, rate	39
6.1.3	Setting the Real Time	41
6.1.4	External input function selection	44
6.1.5	Optional accessory functions of the keys	45
6.2	"PROFI" menu - CHANNEL	
6.2.1	Setting measuring parameters (projection, filters, decimal point, description)	48
6.2.2	Setting mathematic functions	53
6.2.3	Setting integrator parameters	56
6.2.4	Selection of evaluation of min/max. value	60
6.3	"PROFI" menu - OUTPUT	
6.3.1	Setting data logging	62
6.3.2	Setting Limits	64
6.3.3	Setting data output	66
6.3.4	Setting analog output	67
6.3.5	Selection of display projection	69
6.4	"PROFI" menu - SERVICE	
6.4.1	Selection of programming menu „LIGHT"/„PROFI"	70
6.4.2	Restoration manufacture setting	71
6.4.3	Automatic calibration - input range	72
6.4.4	Selection of instrument menu language version	73
6.4.5	Setting new access password	73
6.4.6	Instrument identification	73
7.	Setting items into "USER" men	74
7.0	Configuration "USER" menu	72
8.	Data protocol	76
9.	Error statements	78
10.	Table of symbols	79
11.	Technical data	80
12.	Instrument dimensions and instalation	82
13.	Certificate of guarantee	83
	Declaration of conformity	84

2.1 Description

The OM 502 model series are 5 digit panel programmable instruments.

The instrument is based on 8-bit microcontroller with high-rate 24-bit sigma-delta converter, which secures high accuracy, stability and easy operation of the instrument.

The OM 502 instruments are manufactured in the following types and ranges

DC:	DC Voltmeter/Ammeter ±999,99 mV; ±999,99 mV; ±9,9999 V; ±99,999 V; ±300,00 V ±999,99 µA; ±9,9999 mA; ±99,999 mA; ±999,99 mA; ±5,0000 A
PM:	Process monitor 0...5 mA/0...20 mA/4...20 mA/±2 V/±5 V/±10 V
I:	Integrator 0...5 mA/0...20 mA/4...20 mA/±2 V/±5 V/±10 V
LX:	Linearizerion 0...5 mA/0...20 mA/4...20 mA/±2 V/±5 V/±10 V
DU:	Display unit for linear potentiometers Linear potentiometer (min. 500 Ω)
T:	Weighing indicator 1...4 mV/V; 2...8 mV/V; 4...16 mV/V

PROGRAMMABLE PROJECTION, FUNCTION

Measuring range:	adjustable (PM, I, LX) or as per order (DC, T)
Setting:	manual, optional display projection may be set for both limit values of the input signal, e.g. input 0...20 mA > 0...8500,0
Projection:	±99999 (-99999...999999)
Integration (I):	with time base 1 s, projection of integrated and current value
Weighing function (T):	manual or automatic calibration, signalization of stabilized equilibrium, zero stabilization, automatic zero monitoring, defined number of sections on the scale
Projection (T):	±99999 (Mode - Standard) selection of size of the section - 0,001/0,002/0,005/0,01/0,02/0,05/0,1/0,2/0,5/1/2/5/ 10/20/50/100 (Mode - WEIGHT)

LINEARIZATION

Linearization:	by linear interpolation in 50 points (solely via OM Link)
Linearization (LX):	linear interpolation in 256 points and 16 tables

DIGITAL FILTERS

Floating average:	from 2...30 measurements
Exponen.average:	from 2...100 measurements
Rounding:	setting the projection step for display

MATHEMATIC FUCTIONS

Min/max. value:	registration of min./max. value reached during measurement
Tare:	designed to reset display upon non-zero input signal
Fixed tare:	fixed preset tare
Peak value:	the display shows only max. or min. value
Mat. operations:	polynome, 1/x, logarithm, exponential, power, root, sin x

EXTERNAL CONTROL

Lock:	control keys blocking
Hold:	display/instrument blocking
Tare:	tare activation/resetting tare to zero
Resetting MM:	resetting min/max value
Memory:	data storage into instrument memory

2.2 Operation

The instrument is set and controlled by five control keys located on the front panel. All programmable settings of the instrument are performed in three adjusting modes:

LIGHT	Simple programming menu - contains solely items necessary for instrument setting and is protected by optional number code
PROFI	Complete programming menu - contains complete instrument menu and is protected by optional number code
USER	User programming menu - may contain arbitrary items selected from the programming menu (LIGHT/PROFI), which determine the right (see or change) - access without password

All programmable parameters are stored in the EEPROM memory (they hold even after the instrument is switched off).

 Complete instrument operation and setting may be performed via OM Link communication interface, which is a standard equipment of all instruments.
The operation program is freely accessible (www.orbit.merret.cz) and the only requirement is the purchase of OML cable to connect the instrument to PC. It is manufactured in version RS 232 and USB and is compatible with all ORBIT MERRET instruments. Another option for connection is with the aid of data output RS 232 or RS 485 (without the need of the OML cable).

The program OM LINK in „Basic“ version will enable you to connect one instrument with the option of visualization and archiving in PC. The OM Link „Standard“ version has no limitation of the number of instruments connected.

2.3 Options

Excitation is suitable for supplying power to sensors and transmitters. It has a galvanic separation.

Comparators are assigned to monitor one, two, three or four limit values with relay output. The user may select limits regime: LIMIT/DOSING/FROM-TO. The limits have adjustable hysteresis within the full range of the display as well as selectable delay of the switch-on in the range of 0...99,9 s. Reaching the preset limits is signalled by LED and simultaneously by the switch-on of the relevant relay.

Data outputs are for their rate and accuracy suitable for transmission of the measured data for further projection or directly into the control systems. We offer an isolated RS232 and RS485 with the ASCII, MESSBUS, MODBUS - RTU or PROFIBUS protocol.

Analog outputs will find their place in applications where further evaluating or processing of measured data is required in external devices. We offer universal analog output with the option of selection of the type of output - voltage/current. The value of analog output corresponds with the displayed data and its type and range are selectable in Menu.

Measured data record is an internal time control of data collection. It is suitable where it is necessary to register measured values. Two modes may be used. FAST is designed for fast storage (40 records/s) of all measured values up to 8 000 records. Second mode is RTC, where data record is governed by Real Time with data storage in a selected time segment and cycle. Up to 250 000 values may be stored in the instrument memory. Data transmission into PC via serial interface RS232/485 and OM Link.

3 INSTRUMENT CONNECTION

The instrument supply leads should not be in proximity of the incoming low-potential signals.

Contactors, motors with larger input power should not be in proximity of the instrument.

The leads into the instrument input (measured quantity) should be in sufficient distance from all power leads and appliances. Provided this cannot be secured it is necessary to use shielded leads with connection to ground (bracket E).

The instruments are tested in compliance with standards for use in industrial area, yet we recommend to abide by the above mentioned principles.

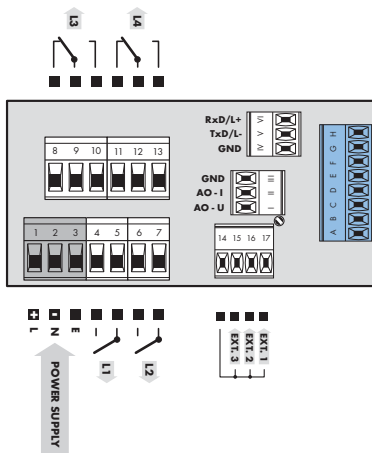

OM 502DC, PM, I, LX

- INPUT U
- GND
- INPUT I
- GND
- Shielding
- GND
- Excitation

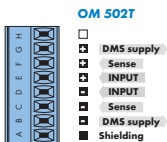

Excitation value may be set by trimmer above the terminal block no. 17

Grounding on terminal block 3 has to be connected at all times

Signal „SENSE“ measures supply voltage on tensionmeter upon 6-wire connection, for 4-wire connection join brackets II+III and VI+VII directly on the instrument. When using the instrument in highly disturbing environment we recommend using 4-wire connection..

Terminal block “Shielding” is designed for connecting shielding of the supply lead (connected only on the side of the instrument). The “Shielding” and “GND” terminal blocks MUST NOT be connected

MEASURING RANGES

Type	Input I	Input U
DC	$\pm 999,99 \mu\text{A}$; $\pm 9,9999 \text{ mA}$; $\pm 99,999 \text{ mA}$; $\pm 999,99 \text{ mA}$; $\pm 5,0000 \text{ A}$	$\pm 999,99 \text{ mV}$; $\pm 999,99 \text{ mV}$; $\pm 9,9999 \text{ V}$; $\pm 99,999 \text{ V}$; $\pm 300,00 \text{ V}$
PM	0...5/20 mA/4...20 mA	$\pm 2/\pm 5/\pm 10 \text{ V}$
I	0...5/20 mA/4...20 mA	$\pm 2/\pm 5/\pm 10 \text{ V}$
LX	0...5/20 mA/4...20 mA	$\pm 2/\pm 5/\pm 10 \text{ V}$
DU	Linear potentiometer (min. 500 Ω)	
T	1...4 mV/V; 2...8 mV/V; 4...16 mV/V;	

Selection of jumpers

X1 - Calibration

- no calibration enabled
- yes calibration disabled

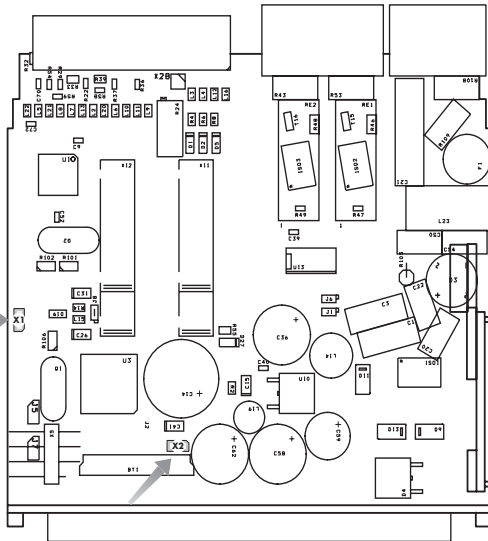

X2 - Battery for RTC

- no Battery off
- yes Battery on

PROFI

Setting

profi

- ▶ For expert users
- ▶ Complete instrument menu
- ▶ Access is password protected
- ▶ Possibility to arrange items of the „User“ menu
- ▶ Tree menu structure

LIGHT

Setting

light

- ▶ For trained users
- ▶ Only items necessary for instrument setting
- ▶ Access is password protected
- ▶ Possibility to arrange items of the „User“ menu
- ▶ Linear menu structure

USER

Setting

*profi light**user*

- ▶ For user operation
- ▶ Menu items are set by the user (Profi/Light) as per request
- ▶ Access is not password protected
- ▶ Optional menu structure either tree (PROFI) or linear (LIGHT)

4.1 Setting

The instrument is set and controlled by five control keys located on the front panel. All programmable settings of the instrument are performed in three adjusting modes:

- LIGHT** **Simple programming menu**
 - contains solely items necessary for instrument setting and is protected by optional number code
- PROFI** **Complete programming menu**
 - contains complete instrument menu and is protected by optional number code
- USER** **User programming menu**
 - may contain arbitrary items selected from the programming menu (LIGHT/PROFI), which determine the right (see or change)
 - acces without password

All programmable parameters are stored in the EEPROM memory (they hold even after the instrument is switched off).

Complete instrument operation and setting may be performed via OM Link communication interface, which is a standard equipment of all instruments.

The operation program is freely accessible (www.orbit.merret.cz) and the only requirement is the purchase of OML cable to connect the instrument to PC. It is manufactured in version RS 232 and USB and is compatible with all ORBIT MERRET instruments.

Another option for connection is with the aid of data output RS 232 or RS 485 (without the need of the OML cable).

Scheme of processing the measured signal

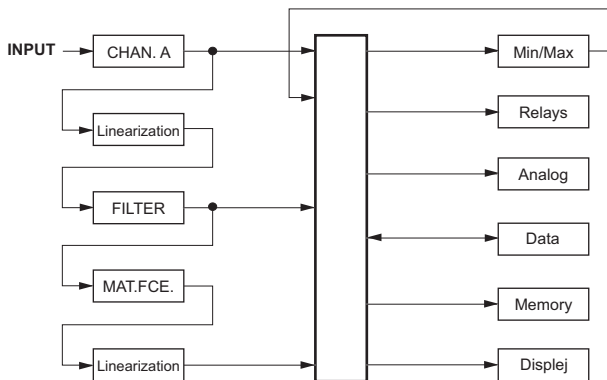

Setting and controlling the instrument is performed by means of 5 control keys located on the front panel. With the aid of these keys it is possible to browse through the operation menu and to select and set required values.

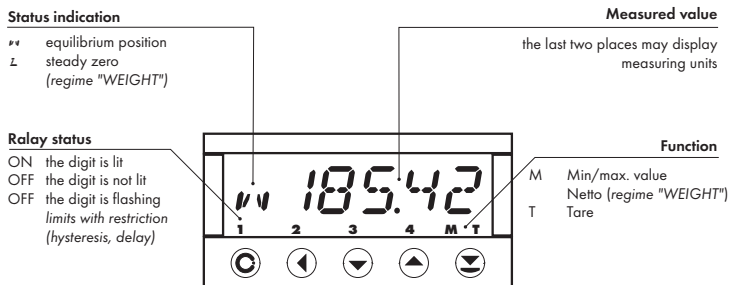

Symbols used in the instructions

DC **PM**

DU **OHM** **RTD** **T/C**

Indicates the setting for given type of instrument

DEF

values preset from manufacture



symbol indicates a flashing light (symbol)



inverted triangle indicates the item that can be placed in USER menu



broken line indicates a dynamic item, i.e. it is displayed only in particular selection/version



after pressing the key the set value will not be stored



after pressing the key the set value will be stored



30 continues on page 30

Setting the decimal point and the minus sign

DECIMAL POINT

Its selection in the menu, upon modification of the number to be adjusted it is performed by the control key **1** with transition beyond the highest decade, when the decimal point starts flashing. Positioning is performed by **▲**/**▼**.

THE MINUS SIGN

Setting the minus sign is performed by the key **▼** on higher decade. When editing the item subtraction must be made from the current number (e.g.: 013 > **▼**, on class 100 > -87)

Control keys functions

Key	Measurement	Menu	Setting numbers/selection
	access into USER menu	exit menu	quit editing
	programmable key function	back to previous level	move to higher decade
	programmable key function	move to previous item	move down
	programmable key function	move to next item	move up
	programmable key function	confirm selection	confirm setting/selection
			numeric value is set to zero
	access into LIGHT/PROFI menu		
	direct access into PROFI menu		
		configuration of an item for "USER" menu	
		determine the sequence of items in "USER - LIGHT" menu	

Setting items into „USER“ menu

- in LIGHT or PROFI menu
- no items permitted in USER menu from manufacture
- on items marked by inverted triangle

user

legend is flashing - current setting is displayed



- item will not be displayed in USER menu
- item will be displayed in USER menu with the option of setting
- item will be solely displayed in USER menu

5.0

Setting "LIGHT"

LIGHT

Simple programming menu

- contains only items necessary for instrument setting and is protected by optional number code

SETTING LIGHT



- For capable users
- Only items necessary for instrument setting
- Access is password protected
- Possibility to arrange items of the „User“ menu
- Linear menu structure

Preset from manufacture

Password	"0"
Menu	LIGHT
USER menu	off
Setting the items	DEF

Access password
 1428 **PASSW**

!
 Upon delay exceeding 60 s the programming mode is automatically discontinued and the instrument itself restores the measuring mode

DC Setting projection

PM Selecting measuring range/Projection setting

I Selecting measuring range/Projection setting/Setting multiplying and dividing constantly

LX Selecting measuring range/Projection setting/Table selection

DU Projection setting

T Selecting measuring mode/Setting projection and tensionmeter sensitivity

Option - comparator

Option - Analog output

Menu type Return to manufacture calibration Return to manufacture setting

Calibration - only for "DU" Language selection

New password Identification **Return to measuring mode**

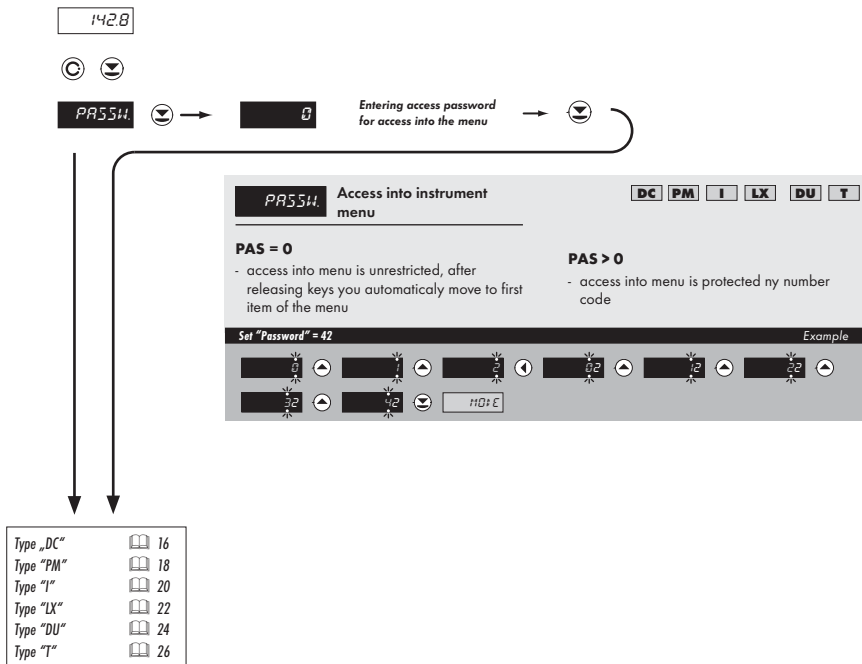

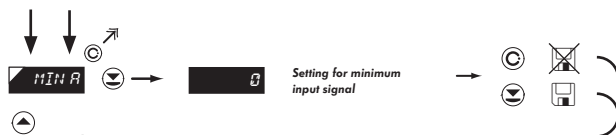

MIN A Setting display projection for minimum value of input signal

- position of the DP does not affect display projection
- the DP is automatically shifted after the value is confirmed

- range of the setting is ± 99999 (-99999...99999)

DEF = 0

Projection for 0 mA > MIN A = -25 Example



MAX A Setting display projection for maximum value of input signal

- position of the DP does not affect display projection
- the DP is automatically shifted after the value is confirmed

- range of the setting is ± 99999 (-99999...99999)

DEF = 100

Projection for 20 mA > MAX A = 2500 Example

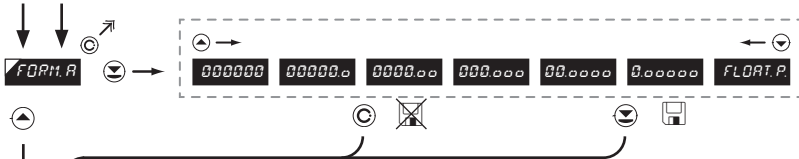

F0000.00 Setting projection of the decimal point **DEF** = 0000.00

- positioning of the DP is set here in the measuring mode

Projection of DP on display > 00000.0 Example

0000.00 ▼ 00000.0 ▼ * subsequent item on the menu depends on instrument equipment

↑

↓

↓

28



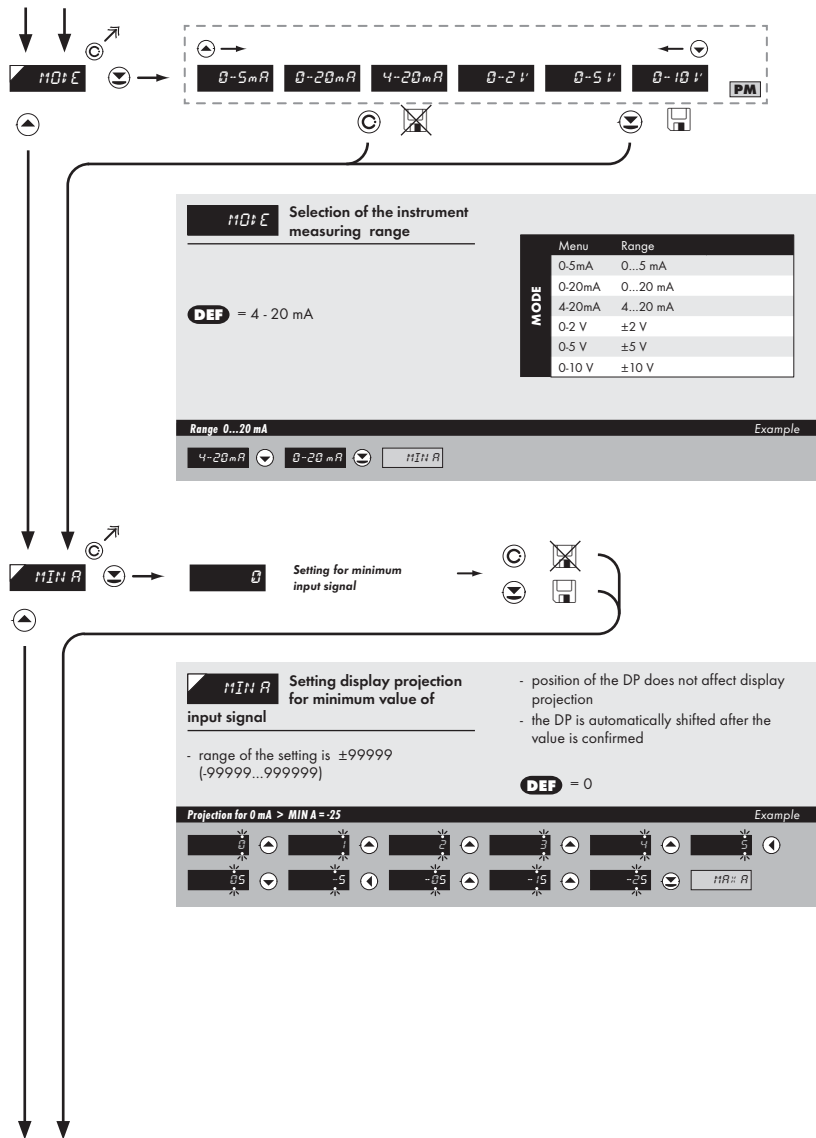



mA: A Setting display projection for maximum value of input signal

- position of the DP does not affect display projection
- the DP is automatically shifted after the value is confirmed

DEF = 100

Projection for 20 mA > MAX A = 2500 Example

100	150	100	200	300	400
500	500	500	500	FORM: A	

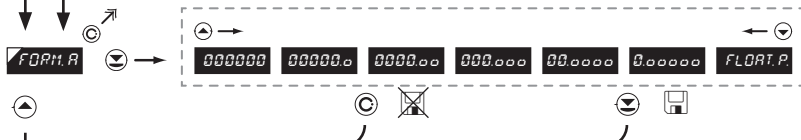

FORM: A Setting projection of the decimal point

DEF = 0000.00

- positioning of the DP is set here in the measuring mode

Projection of DP on display > 00000.0 Example

0000.00	00000.0	HELD
---------	---------	------

* subsequent item on the menu depends on instrument equipment

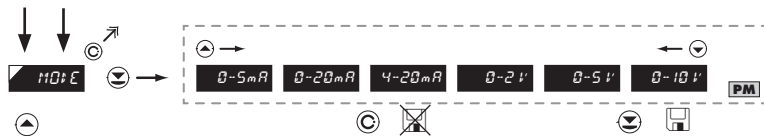

HD: E Selection of the instrument measuring range

DEF = 4 - 20 mA

MODE	Menu	Range
	0-5mA	0...5 mA
	0-20mA	0...20 mA
	4-20mA	4...20 mA
	0-2 V	±2 V
	0-5 V	±5 V
	0-10 V	±10 V

Range 0...20 mA Example

4-20mA 0-20mA MIN R



MIN R Setting display projection for minimum value of input signal

- range of the setting is ±99999 (99999...999999)
- position of the DP does not affect display projection
- the DP is automatically shifted after the value is confirmed

DEF = 0

Projection for 0 mA > MIN A = 10 Example

0 10 20 30 MIN R



MAX R Setting display projection for maximum value of input signal

- range of the setting is ±99999 (99999...999999)
- position of the DP does not affect display projection
- the DP is automatically shifted after the value is confirmed

DEF = 100

Projection for 20 mA > MAX A = 2500 Example

100 200 300 400 500 1000 2000 3000 4000 5000 MAX R SCALE

SCALE Setting the multiplying constant

constant it is easy to set the displayed value for required time period

- range of the setting is 1...100 000
- by using the multiplying and dividing

DEF = 1

Multiplying constant > NASOB. = 1 Example

I/I: I Selecting the dividing constant

- by using the multiplying and dividing constant it is easy to set the displayed value for required time period

- range 1/10/60/100/1 000/3 600

DEF = 1

Dividing constant 3600 > DIVID. = 3600 Example

FORM: I Setting projection of the decimal point

- positioning of the DP is set here in the measuring mode

DEF = 0000.00

Projection of DP on display > 00000.0 Example

* subsequent item on the menu depends on instrument equipment

28

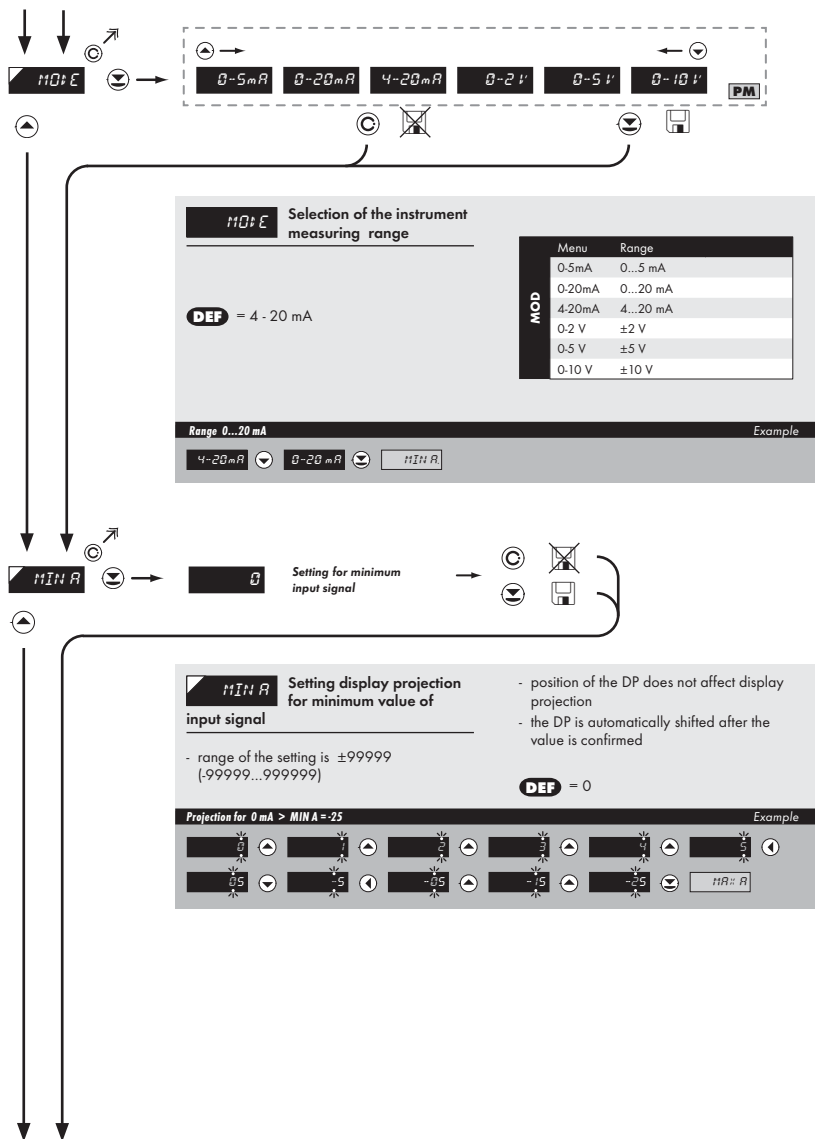

11A :: R → **100** Setting for maximum input signal →

11A :: R Setting display projection for maximum value of input signal

- position of the DP does not affect display projection
- the DP is automatically shifted after the value is confirmed

 DEF = 100

Projection for 20 mA > Max = 2500 Example

100	100	100	200	300	400
500	0500	500	2500	TAB ::	

TAB :: → **TAB 0** **TAB 1** ... **TAB 14** **TAB 15**

TAB :: Selection of the linearization table

DEF = TAB. 0

Selection of the linearization table - Tabulka 1 > TAB. 1 Example

TAB 0	TAB 1	FORM.H
-------	-------	--------

FORM.H → **000000** **000000** **000000** **000000** **00.0000** **0.00000** **FLOAT.P**

FORM.H Setting projection of the decimal point

DEF = 0000.00

- positioning of the DP is set here in the measuring mode

Projection of DP on display > 00000.0 Example

0000.00	00000.0	MECHU
---------	---------	-------

* subsequent item on the menu depends on instrument equipment



MIN A

Setting display projection
for minimum value of
input signal

- range of the setting is ± 99999
(-99999...99999)

- position of the DP does not affect display projection
- the DP is automatically shifted after the value is confirmed

DEF = 0

Projection for the beginning > MIN A = 0

Example

MIN A



MAX A

Setting display projection
for maximum value of
input signal

- range of the setting is ± 99999
(-99999...99999)

- position of the DP does not affect display projection
- the DP is automatically shifted after the value is confirmed

DEF = 100

Projection for the end > MAX A = 5000

Example

1000 ← 1000 ↓ 1000 ↓ 0000 ← 0000 ↑ 1000 ↑

2000 ↑ 3000 ↑ 4000 ↑ 5000 ↓ **DEF** A

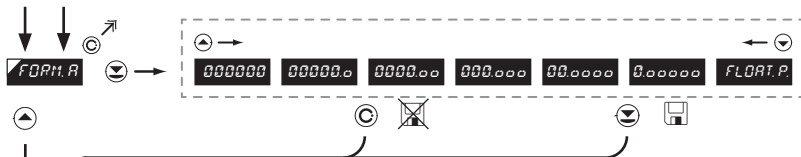

FORM.A Setting projection of the decimal point **DEF** = 0000.00

- positioning of the DP is set here in the measuring mode

Projection of DP on display > 0000.00 Example

0000.00 **MENU** * subsequent item on the menu depends on instrument equipment

28

Calibration of the beginning and the end of range of linear potentiometer is on page 33



The diagram illustrates the navigation flow between two menu screens:

- Top Screen (Selection of measuring mode):**
 - Display: **MODE: E**
 - Navigation: Press **↑** to go to the previous screen, **↓** to go to the next screen, **←** to move left, and **→** to move right.
 - Content: A dashed box highlights the **STAND.** and **WEIGHT** options. A **DEF** button is shown below.
 - Table:

MODE	Menu	Measuring mode
	STAND.	Standard
	WEIGHT	Weighing function
 - Example: **Mode "WEIGHT"** (Example)
- Bottom Screen (Setting the tensionmeter range):**
 - Display: **MR: R**
 - Navigation: Press **↑** to go to the previous screen, **↓** to go to the next screen, **←** to move left, and **→** to move right.
 - Content: **100** is displayed. A **DEF** button is shown to the right.
 - Text: **Setting the tensionmeter range**
 - Notes:
 - position of the DP does not affect display projection
 - DP is automatically shifted after the value is confirmed
 - DEF = 100
 - Text: **Weighing range is 200 kg > MAXA = 200**
 - Example: A sequence of screens showing the range being set from **100** to **200** using the **SENSE** button.

!

Manual calibration:

MAX Sensor range

SENSE Sensor sensitiveness

Automatic calibration
(after calibration in menu "SERVIC./CALIB."):

MIN The load at which minimum calibration was performed

MAX The load at which maximum calibration was performed

- for maximum calibration we recommend the value of reference load to be in the upper third of the measuring range

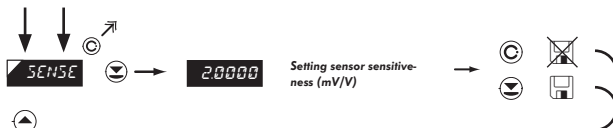

SENSE Setting display projection for maximum input signal value

- DP is automatically shifted after the value is confirmed
- range of the setting: 0,2...4,0 [1...4 mV/V]
- range of the setting: 0,4...8,0 [2...8 mV/V]
- range of the setting: 0,8...16,0 [1...4 mV/V]

DEF = 2.00

Sensitivity 2,0018 > SENSE = 2,0018 Example

2	0	0	0	0	0	0	0	0	0	0	0	0	0
0	0	0	0	0	0	0	0	0	0	0	0	0	0
0	0	0	0	0	0	0	0	0	0	0	0	0	0

FORM.A

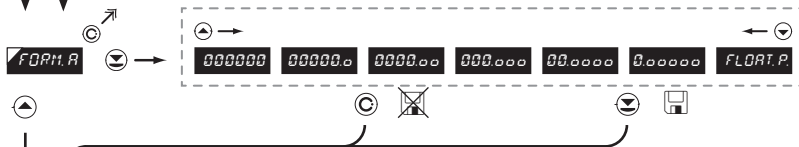

FORM.A Setting projection of the decimal point

- positioning of the DP is set here in the measuring mode

DEF = 0000.00

Projection of DP on display > 0000.00 Example

0	0	0	0	0	0	0	0	0	0	0	0	0	0
0	0	0	0	0	0	0	0	0	0	0	0	0	0
0	0	0	0	0	0	0	0	0	0	0	0	0	0

HEHL

* subsequent item on the menu depends on instrument equipment

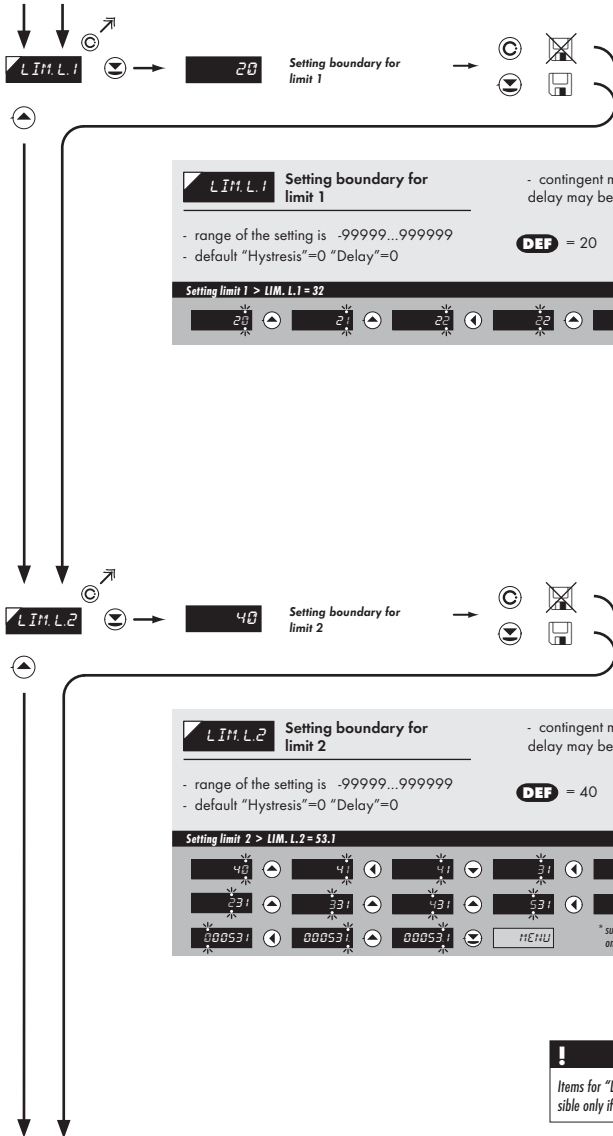



LIM.L3 Setting boundary for limit 3

- contingent modification of hysteresis or delay may be performed in "PROFI" menu

- range of the setting is -99999...999999
 - default "Hysteresis"=0 "Delay"=0

DEF = 60

Setting limit 3 > LIM.L3 = 85 Example

60	61	62	63	64	65
65	65	65	11E+11		

* subsequent item on the menu depends on instrument equipment



LIM.L4 Setting boundary for limit 4

- contingent modification of hysteresis or delay may be performed in "PROFI" menu

- range of the setting is -99999...999999
 - default "Hysteresis"=0 "Delay"=0

DEF = 80

Setting limit 4 > LIM.L4 = 103 Example

80	81	82	83	83	83
83	803	103	11E+11		

* subsequent item on the menu depends on instrument equipment

↓ ↓ ↗

TYP.AO. →

0-20mA E. 4-20 4-20mA 0-5mA 0-2V 0-5V 0-10V

↑ C X ↓

TYP.AO. Setting the type of analog output

Menu	Range	Description
0-20mA	0...20 mA	
E. 4-20mA	4...20 mA	with indication of error statement (<3,6 mA)
4-20mA	4...20 mA	
0.5mA	0...5 mA	
0-2 V	0...2 V	
0-5 V	0...5 V	
0-10 V	0...10 V	

DEF = 4...20 mA

Type of analog output - 0...10V > TYP.AV. = U 10 Example

4-20mA 0-5mA 0-2V 0-5V 0-10V **MIN.AO.**

↓ ↓ ↗

MIN.AO. → 0

Assigning the display value to the beginning of the AO range

↑ C X ↓

MIN.AO. Assigning the display value to the beginning of the AO range **DEF** = 0

- range of the setting is -99999...99999

Display value for the beginning of the AO range > MIN.AV. = 0 Example

MIN.AO.

!

Items for "Limits" and "Analog output" are accessible only if incorporated in the instrument.

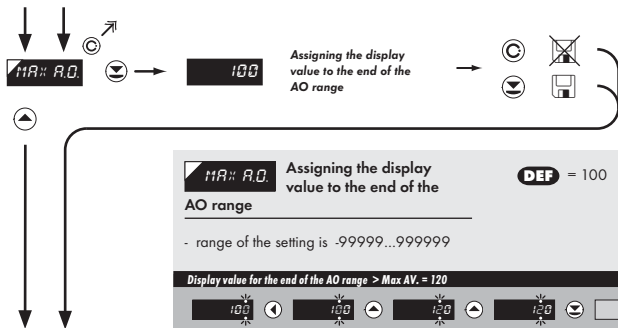

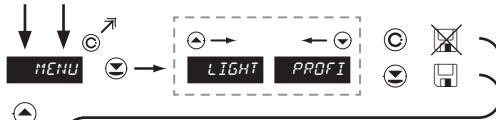

MENU Setting the menu type LIGHT/PROFI

LIGHT > menu LIGHT, a simple menu, which contains only the most essential items necessary for instrument setting
> linear tree structure

PROFI > menu PROFI, a complete menu for complete instrument setting
> tree menu structure

DEF = LIGHT

Menu LIGHT > MENU = LIGHT

Example

LIGHT CALIB



CALIB. Restoration of manufacture calibration

- in the event of error calibration it is feasible to restore manufacture setting.

- prior to execution of any modifications you will be asked to confirm your selection. (YES)

Restoration of manufacture calibration > CALIB.

Example

CALIB. YES SETTIN

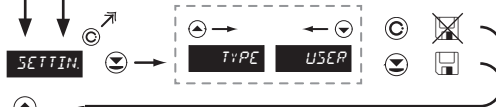

SETTIN. Restoration of manufacture instrument setting

- in the event of error setting the manufacture setting may be restored
- restoration is performed for the currently selected type of the instrument input (select "TYPE")

- provided you stored your user setting in the "PROFI" menu, it may also be restored (select "USER")
- loading manufacture calibration and primary setting of items on the menu (DEF)

Restoration of manufacture setting > SETTIN.

Example

SETTIN. TYPE LANG

* subsequent item on the menu depends on instrument type, for "DU" > "K. MIN"

Type „DC“		34
Type „PM“		34
Type „I“		34
Type „LX“		34
Type „DU“		33
Type „T“		34

!
Automatická kalibrace je nutná pouze pro typ "DU", pro ostatní verze dle požadavků uživatele

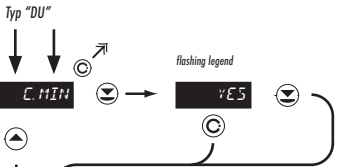

C. MIN Calibration of input range - the potentiometer traveller in initial position Only for type "DU"

- prior confirming the flashing "YES" sign the potentiometer traveller has to be in given idle position

Calibration of the beginning of the range > C. MIN Example

YES C. MAX

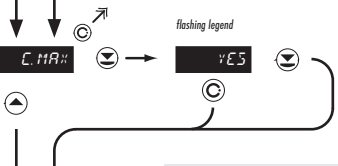

C. MAX Calibration of input range - the potentiometer traveller in end position Only for type "DU"

- prior confirming the flashing "YES" sign the potentiometer traveller has to be in given idle position

Calibration of the end of the range > C. MAX Example

YES LANG



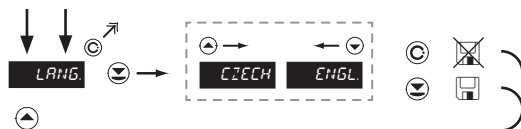

LANG. Selection of language in instrument menu

- selection of language version of the instrument menu

DEF = ENGL.

Language selection - ENGLISH > LANG. = ENGL. Example

CZECH ▲ ENGL ▼ N. PASS

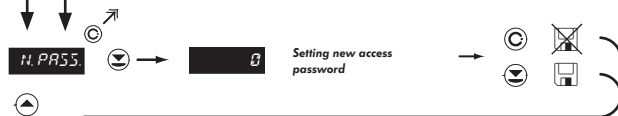

N. PASS. Setting new access password

- access password for menu LIGHT/PROFI

- range of the number code 0...9999

DEF = 0

New password - 341 > N.PASS. = 341 Example

0 ▲ 1 ▲ 2 ▲ 3 ▲ 4 ▲ 5 ▲ 6 ▲ 7 ▲ 8 ▲ 9 ▲

0 ▼ 1 ▼ 2 ▼ 3 ▼ 4 ▼ 5 ▼ 6 ▼ 7 ▼ 8 ▼ 9 ▼

Is ENT

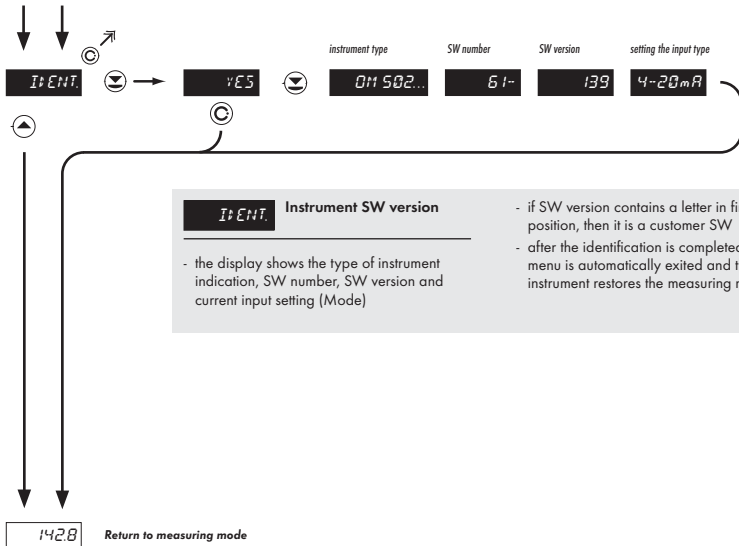

PROFI

Complete programming menu

- contains complete instrument menu and is protected by optional number code
- designed for expert users
- preset from manufacture is menu **LIGHT**



- For expert users
- Complete instrument menu
- Access is password protected
- Possibility to arrange items of the „User“ menu
- Tree menu structure

Switchng over to "PROFI" menu



- direct access to **PROFI** menu, irrespective of the menu type setting (SERVICE/MENU)
- after quitting **PROFI** menu the instrument automatically switches to **LIGHT** menu
- access is password protected (if it was not set under item N. PASS. =0)



- access into „menu“ (**LIGHT/PROFI**) according to the setting in item (SERVICE/MENU)
- access is password protected (if it was not set under item N. PASS. =0)

6.1 Setting "PROFI" - INPUT

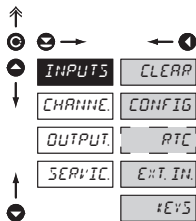

The primary instrument parameters are set in this menu

- CLEAR** Resetting internal values
- CONFIG** Selection of measuring range and parameters
- RTC** Setting date and time for option with RTC
- EXT. IN** Setting external inputs functions
- EYS** Assigning further functions to keys on the instrument

6.1.1 Resetting internal values

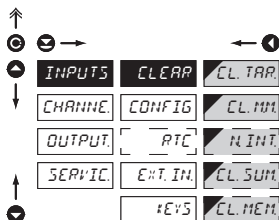

- CLEAR** Resetting internal values to zero
- CL.TAR** Tare resetting
- CL.MM** Resetting min/max value
 - resetting memory for storing the minimum and maximum values reached during measurement
- CL.INT** Resetting integrated value
 - only for instrument OM 5021
- CL.SUM** Resetting the sum
 - summation serves for cumulative totals of values (e.g. shift operation), when after resetting the integrator ("CL INT") the display value is added to the total ("SUM")
 - only for instrument OM 5021
- CL.MEM** Clear instrument memory
 - clear memory with data measured in the "FAST" or "RTC" mode
 - not in standard instrument equipment

6.1.2a Selection of measuring rate

Navigation icons: Up, Home, Left, Right, Down, and a small circle with a dot.

INPUTS	CLEAR	MEAS./S	100.0
CHANNEL	CONFIG	MODE	66.7
OUTPUT	PTC	TRACED	50.0
SERVIC.	EXT. IN.	A. ZERO	25.0
	#EVS		12.5
			10.0
			8.0
			4.0
		DEF	2.0
			1.0
		DEF WEIGHT	0.5
			0.3
			0.1

MEAS./S Selection of measuring rate

100.0	100,0 measurements/s
66.7	66,7 measurements/s
50.0	50,0 measurements/s
25.0	25,0 measurements/s
12.5	12,5 measurements/s
10.0	10,0 measurements/s
8.0	8,0 measurements/s
4.0	4,0 measurements/s
DEF	
2.0	2,0 measurements/s
1.0	1,0 measurements/s
DEF	for OM 502T > mode WEIGHT
0.5	0,5 measurements/s
0.3	0,3 measurements/s
0.1	0,1 measurements/s

6.1.2b Selection of measuring range/mode

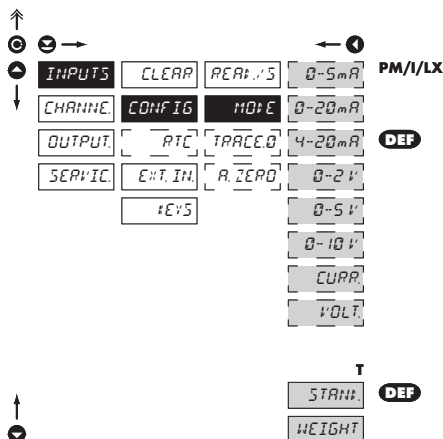
MODE Selection of instrument measuring range/mode

Menu	Range
0-5mA	0...5 mA
0-20mA	0...20 mA
4-20mA	4...20 mA
0-2 V	±2 V
0-5 V	±5 V
0-10 V	±10 V
CURR.	Current range after automatic calibration
VOLT.	Voltage range after automatic calibration

Menu	Measuring mode
T STANB	Standard mode
WEIGHT	Weighing mode

6.1.2c Selection of automatic zero monitoring

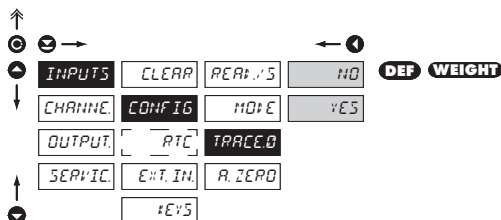
TRACE0 Selection of automatic zero monitoring

NO	Function is off
YES	Function is on

- in 4% of the measuring range zero automatically faces the condition that correction must not be larger than 0,5 section/sec
- setting is possible only for mode "WEIGHT"

6.1.2.d Selection of automatic weight resetting

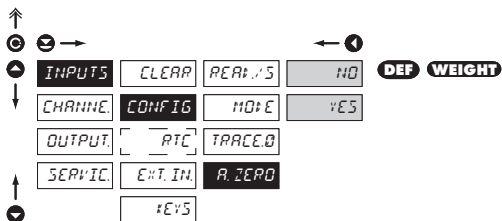
T

A. ZERO Selection of automatic weight resetting

NO Function is off

YES Function is one

- if stabilized negative value is displayed for a period > 5 s (at active Tare function) the tare is automatically reset
- selection is possible only for mode "WEIGHT"

6.1.3 Setting the real time clock

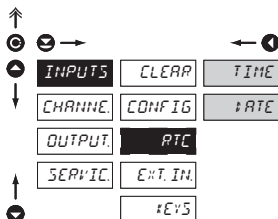

RTC Setting the real time clock (RTC)

TIME Time setting

- format 23.59.59

DATE Date setting

- format DD.MM.YY

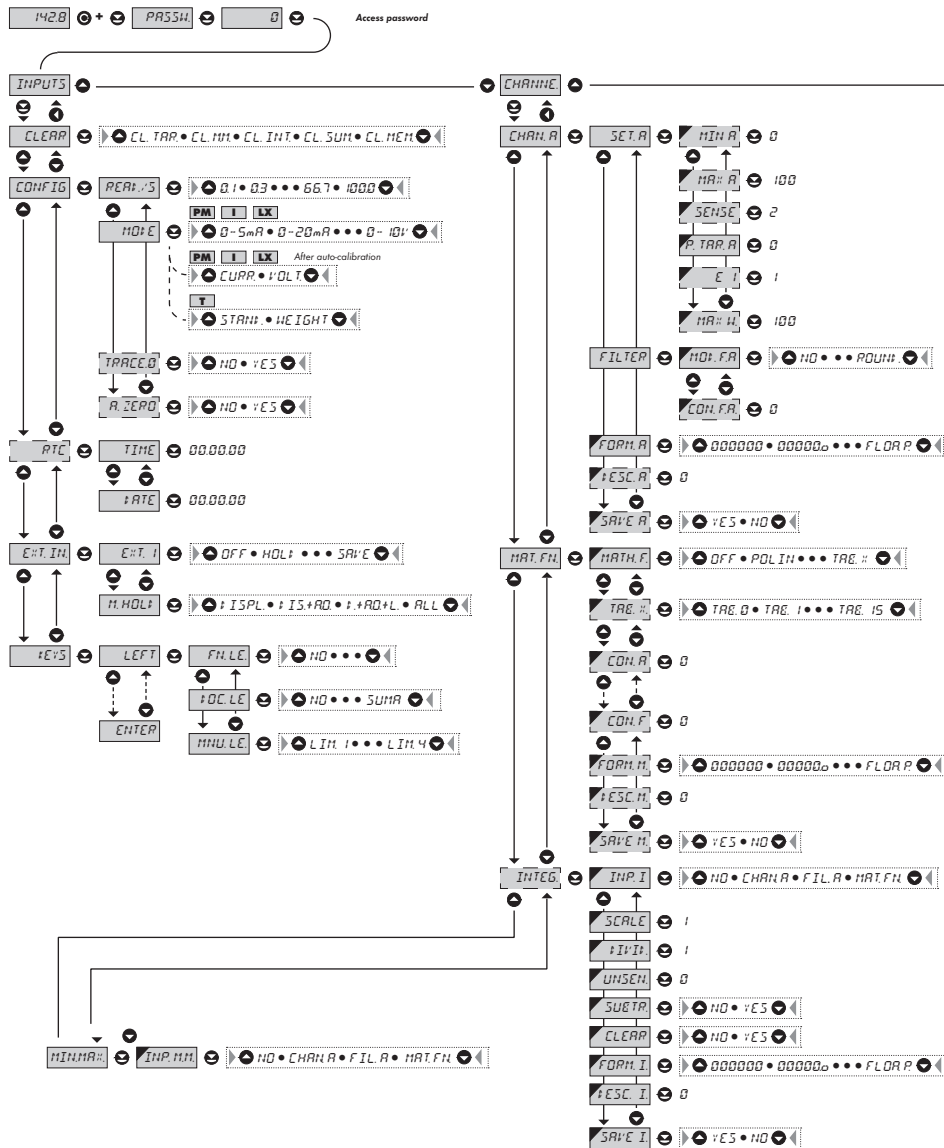

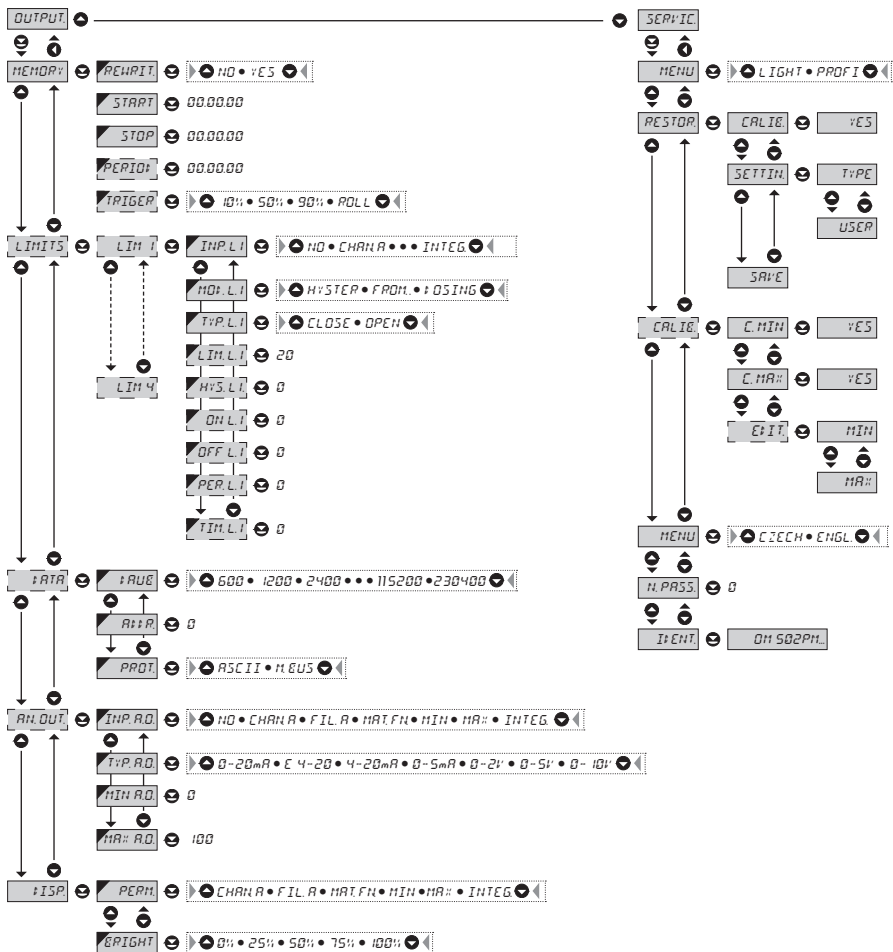

!
 Upon delay exceeding 60 s the programming mode is automatically discontinued and the instrument itself restores the measuring mode

6.1.1a External input function selection

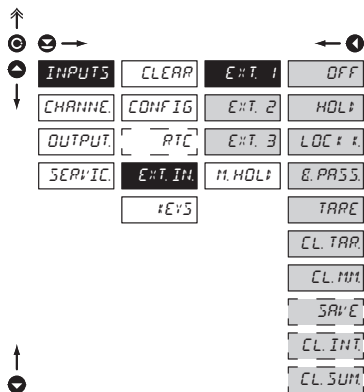
EXT. IN. External input function selection

- OFF** Input is off
- HOLD** Activation of HOLD
- LOCK K.** Locking keys on the instrument
- EXT. IN.** Activation of locking access into programming menu LIGHT/PROFI
- TARE** Tare activation
- CL. TARE** Tare resetting
- CL. MIN** Resetting min/max value
- SAVE** Activation of the measured data record into instrument memory (not in standard equipment)
- CL. INT.** Resetting integrated value
 - only for instrument OM 5021
- CL. SUM** Resetting the sum
 - only for instrument OM 5021

- **DEF** EXT. 1 > HOLD
- **DEF** EXT. 2 > LOCK. K.
- **DEF** EXT. 3 > TARE

*

Setting procedure is identical for Ext. 2 and Ext. 3

6.1.4b Selection of function "HOLD"

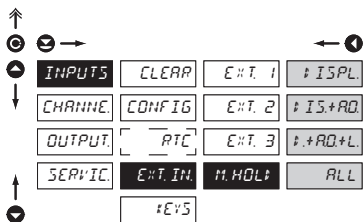

M. HOLD Selection of function "HOLD"

↵ ISPL "HOLD" locks only the value displayed

↵ IS+RD "HOLD" locks the value displayed and on AO

↵ +RD+L "HOLD" locks the value displayed, on AO and limit evaluation

ALL "HOLD" locks the entire instrument

6.1.5a Optional accessory functions of the keys

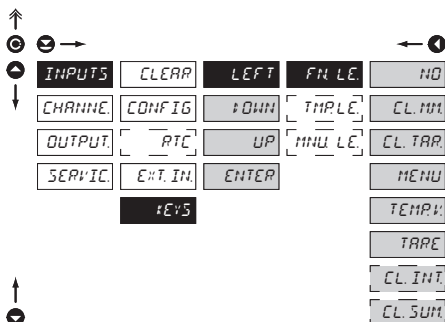

FN. LE. Assigning further functions to instrument keys

- „FN. LE.“> executive functions
- „TMP. LE.“> temporary projection of selected values
- „MNU. LE.“> direct access into menu on selected item

NO Key has no further function

CL. MIN. Resetting min/max value

CL. TAR. Tare resetting

MENU Direct access into menu on selected item

- after confirmation of this selection the "MENU" item is displayed on superior menu level, where required selection is performed

TEMP. V. Temporary projection of selected values

- after confirmation of this selection the item "TEMPOR." is displayed on superior menu level, where required selection is performed

TARE Tare function activation

CL. INT. Resetting integrated value

CL. SUM. Resetting the sum



Preset values of the control keys DEF:

LEFT	Show Tare
UP	Show Max. value
DOWN	Show Min. value
ENTER	w/o function

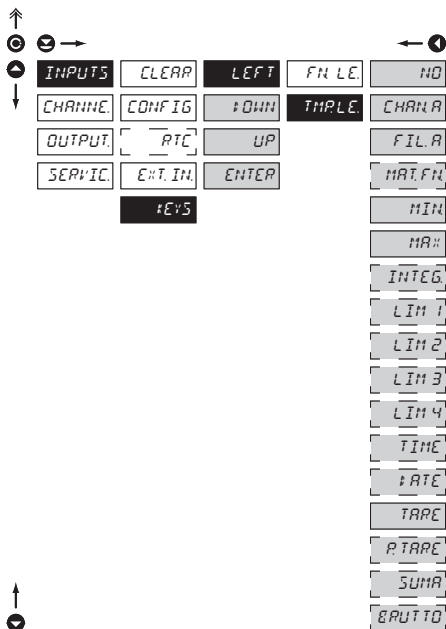

Setting is identical for LEFT, DOWN, UP and ENTER

6.1.5b Optional accessory functions of the keys - Temporary projection

Setting is identical for LEFT, DOWN, UP and ENTER

TMPL

Temporary projection of selected item

- "Temporary" projection of selected value is displayed for the time of keystroke
- "Temporary" projection may be switched to permanent by pressing + "Selected key", this holds until the stroke of any key

	Temporary projection is off
	Temporary projection of "Channel A" value
	Temporary projection of "Channel A" value after processing digital filters
	Temporary projection of "Mathematic functions" value
	Temporary projection of "Min. value"
	Temporary projection of "Max. value"
	Temporary projection of "Integrated value"
	Temporary projection of "Limit 1" value
	Temporary projection of "Limit 2" value
	Temporary projection of "Limit 3" value
	Temporary projection of "Limit 4" value
	Temporary projection of "TIME" value
	Temporary projection of "DATE" value
	Temporary projection of "TARE" value
	Temporary projection of "P. TARE" value
	Temporary projection of "SUM"
	Temporary projection of the sum of the values of "CHAN. A + TARE + P.TARE"

6.1.5c Optional accessory functions of the keys - Direct access to item

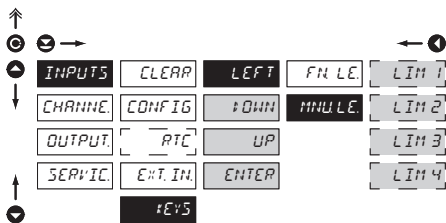

MNU. LE. Assigning access to selected menu item

- LIM 1 Direct access to item "LIM 1"
- LIM 2 Direct access to item "LIM 2"
- LIM 3 Direct access to item "LIM 3"
- LIM 4 Direct access to item "LIM 4"



Setting is identical for LEFT, DOWN, UP and ENTER

6.2 Setting "PROFI" - CHANNELS

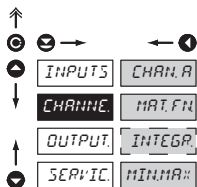

The primary instrument parameters are set in this menu

- CHAN.A** Setting parameters of measuring "Channel"
- MAT.FN** Setting parameters of mathematic functions
- INTEGR** Setting parameters for integrator (OM 5021)
- MINMAX** Selection of access and evaluation of Min/max value

6.2.1a Projection on display - manual calibration

DC PM DU I LX

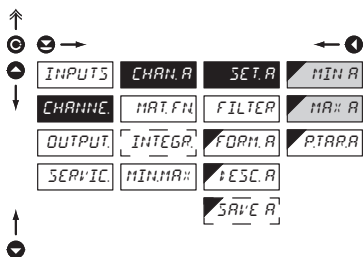
**SET.A** Setting display projection

MIN.A Setting display projection for minimum value of input signal

- range of the setting is -99999...999999
- menu is dynamic, after using automatic calibration this item is no more displayed
- **DEF** = 0

MA::A Setting display projection for maximum value of input signal

- range of the setting is -99999...999999
- **DEF** = 100

6.2.1b Projection on display - manual calibration

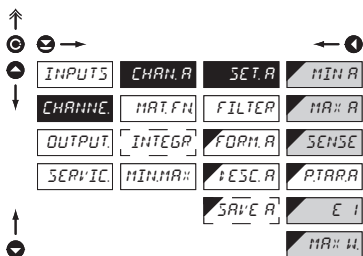
T

!

Manual calibration:

MAX Sensor range

SENSE Sensor sensitiveness

Automatic calibration
(after calibration in menu "SERVICE/CALIB."):

MIN size of load, with which minimum calibration was performed

MAX size of load, with which maximum calibration was performed

- upon maximum calibration we recommend the reference load value in the upper third of the measuring range

SET.A Setting display projection

MIN.A Setting display projection for minimum value of input signal

- range of the setting is -99999...999999
- menu is dynamic, in manual calibration this item is not displayed
- **DEF** = 0

MA::A Setting display projection for maximum value of input signal

- range of the setting is -99999...999999
- **DEF** = 100

SENSE Setting the tensionmeter sensitiveness (mV/V)

- range 1...4/2...8/4...16 mV/V
- fixed resolution in 4 decimal points
- menu is dynamic, the item is displayed only in automatic calibration

E I Setting the size of sections for projection

- range 0.001-0.002-0.005-0.01...100

MA::W. Setting the upper weighing limit

- range of the setting: -99999...999999

6.2.1c Setting fixed tare

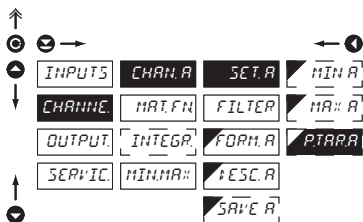

P.TAR.A Setting "Fixed tare" value

- setting is designed for the event when it is necessary to firmly shift the beginning of the range by known size
- when setting (P.TAR. A > 0) display shows "T" symbol
- range of the setting is 0...9999999
- **DEF** = 0

6.2.1d Digital filters

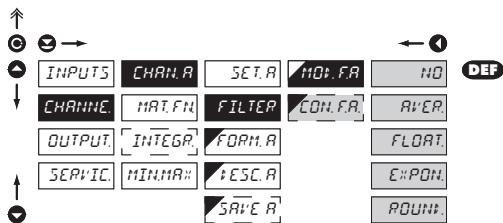
**HO.FA** Selection of digital filters

- at times it is useful for better user projection of data on display to modify it mathematically and properly, wherefore the following filters may be used:

NO Filters are off

AVER Measured data average

- arithmetic average from given number („CON. F.A.“) of measured values
- range 2...100

FLDRT Selection of floating filter

- floating arithmetic average from given number („CON. F.A.“) of measured data and updates with each measured value
- range 2...30

EXPON Selection of exponential filter

- integration filter of first prvního grade with time constant („CON. F.A.“) measurement
- range 2...100

ROUND Measured value rounding

- is entered by any number, which determines the projection step (e.g. „CON. F.A.“=2,5 > display 0, 2.5, 5,...)

CON. F.A. Setting constants

- this menu item is always displayed after selection of particular type of filter

- **DEF** = 2

6.2.1e Projection format - positioning of decimal point

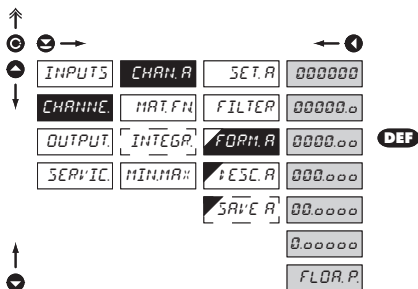

FORM.A Selection of decimal point

- the instrument allows for classic projection of a number with positioning of the DP as well as projection with floating DP, allowing to display a number in its most exact form „FLOAT.P.“

000000. Setting DP - XXXXXX.

00000.0 Setting DP - XXXX.X

0000.00 Setting DP - XXXX.xx

000.000 Setting DP - XXX.xxx

00.0000 Setting DP - XX.xxxx

0.00000 Setting DP - X.xxxxx

FLOA.P. Floating DP

6.2.1f Projection of description - the measuring units

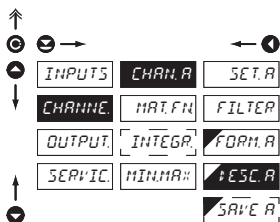

ESC.A Setting projection of descrip. for "Channel A"

- projection of measured data may be extended (at the expense of the number of displayed places) by two characters for description
- description is set by shifted ASCII code, when two first places show the set description and two last characters their code in period 0...95
- description is cancelled by code 00

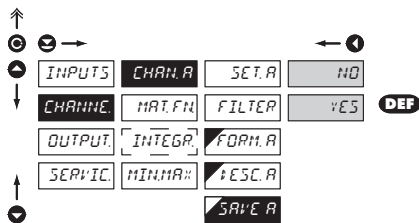

Table of signs on page 79

6.2.1g Selection of storing data into instrument memory

SAVE A Selection of storing data into instrument memory

- by selection in this item you allow to register values into instrument memory
- another setting in item "OUTPUT. > MEMORY" (not in standard experiment)

YES	Measured data are stored in the memory
NO	Measured data are not stored

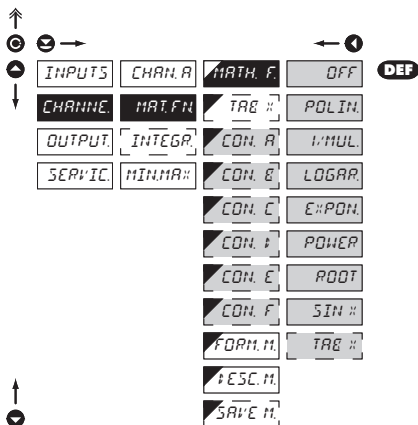
6.2.2a Mathematic functions

MATH.F. Selection of mathematic functions

OFF Mathematic functions are off

POLIN Polynome

$$Ax^2 + Bx^1 + Cx^0 + Dx^2 + Ex + F$$

I:MUL. $1/x$

$$\frac{A}{x^2} + \frac{B}{x^1} + \frac{C}{x^0} + \frac{D}{x^2} + \frac{E}{x} + F$$

LOGAR. Logarithm

$$A \times \ln\left(\frac{Bx+C}{Dx+E}\right) + F$$

E::PON. Exponential

$$A \times e^{\left(\frac{Bx+C}{Dx+E}\right)} + F$$

POWER Power

$$A \times (Bx+C)^{(Dx+E)} + F$$

ROOT Root

$$A \times \sqrt{\frac{Bx+C}{Dx+E}} + F$$

SIN :: Sin x

$$A \sin^5 x + B \sin^4 x + C \sin^3 x + D \sin^2 x + E \sin x + F$$

TABE :: Turning on the linearization table
- this menu is available only in OM 502LX

CON. - Setting constants for calculation of mat. functions
- this menu is displayed only after selection of given mathematic function

6.2.2b Mathematics functions - selection of linearization table

LX

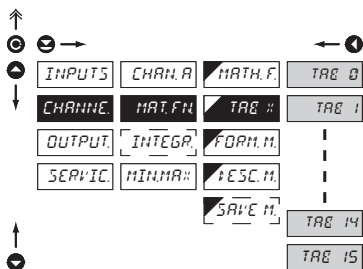
TABLE # Selection of linearization table

- this item is available only in type OM 502LX

TABLE 0 Table number 0

TABLE 1 Table number 1

TABLE 14 Table number 14

TABLE 15 Table number 15

6.2.2c Mathematics functions - decimal point

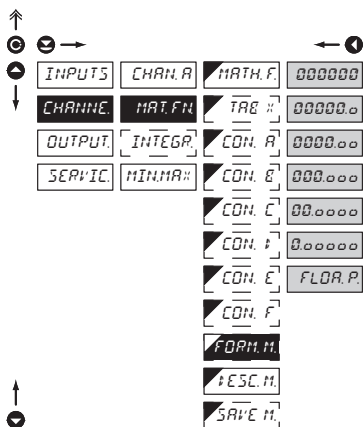
FORM.M Selection of decimal point

- the instrument allows for classic projection of a number with positioning of the DP as well as projection with floating DP, allowing to display a number in its most exact form „FLOA.P.“

000000 Setting DP - XXXXX.

00000.0 Setting DP - XXXX.x

0000.00 Setting DP - XXXX.xx

000.000 Setting DP - XXX.xxx

00.0000 Setting DP - XX.xxxx

0.00000 Setting DP - X.xxxxx

FLOA.P. Floating DP

DEF

6.2.2d Mathematics - measuring units

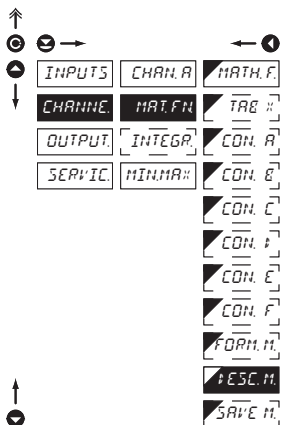

ESC.M. Setting projection of description for "MAT.FN"

- projection of measured data may be extended (at the expense of the number of displayed places) by two characters for description
- description is set by shifted ASCII code, when two first places show the set description and two last characters their code in period 0...95
- description is cancelled by code 00
- **DEF** = no description



Table of signs on page 79

6.2.2e Mathematics - selection of storing data into instrument memory

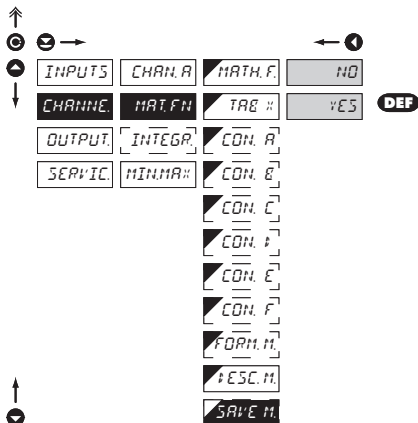

SAVE.M. Selection of storing data into instrument memory

- by selection in this item you allow to register values into instrument memory
- another setting in item "OUTPUT. > MEMORY" (not in standard experiment)

- YES** Measured data are stored in the memory
- NO** Measured data are not stored

6.2.3a Selection of input quantity for calculation

1

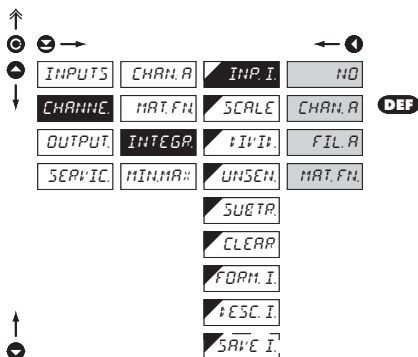
**INP.I.** Selection of input quantity for calculation

- selecting value from which the integrated value will be calculated

NO Evaluation of min/max value is off

CHAN.A From "Channel A"

FIL.A From "Channel A" after modification by dig.filter

MAT.FN From "Mathematic functions"



Primary setting of "Integrator" range is under "CHANNELS/SETTING A/MAX A, where maximum projection is set at time base 1 s

6.2.3b Setting calibration constants

1

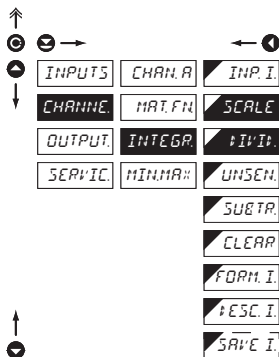
**SCALE** Setting the multiplying constant

- through multiplying constant we may further mathematically adjust the data display projection

- range of the setting is 1...100 000

- **DEF** = 1

DIV.I. Setting the dividing constant

- through dividing constant we may further mathematically adjust the data display projection

- range 1/10/60/100/1000/3600

- **DEF** = 1

6.2.3c Setting the "zero" band of insensitivity

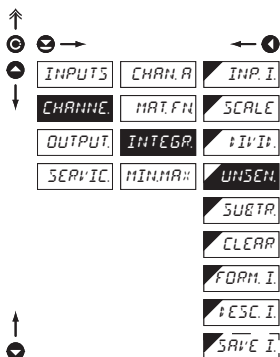
1

UNSEM. Setting the band of insensitivity

- by setting this item it is possible to extend "Zero" and thus achieve integration of the input signal from the set value
- range of the setting is 0...100 000
- **DEF** = 0

6.2.3d Selection of the type of integration

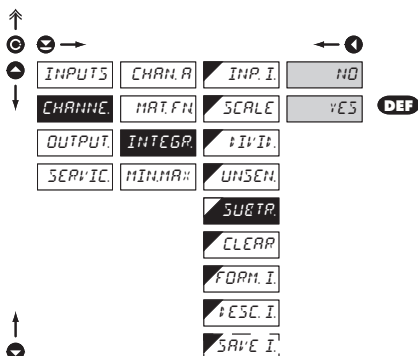
1

SUBTR. Selection of the type of integration

- the selection allows to suppress the negative value of input signal, i.e. the instrument integrates only in positive values (adds up)

Subtraction is off

Subtraction enabled

6.2.3e Selection of automatic resetting

1

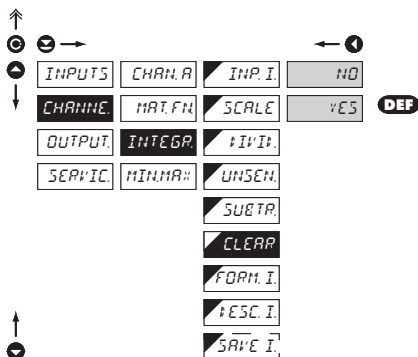
**CLEAR** Selection of automatic resetting to zero

- in this step it is possible to allow automatic resetting upon display overflow

NO

Automatic resetting is off

- upon display overflow error statement is displayed

YES

Automatic resetting is enabled

- upon display overflow the instrument is automatically reset to zero and proceeds in continuous measuring

6.2.3f Selection of projection format

1

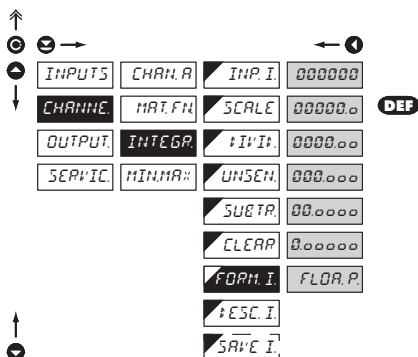
**FORM.I** Selection of decimal point

- the instrument allows for classic projection of a number with positioning of the DP as well as projection with floating DP, allowing to display a number in its most exact form „FLOAT.P.“

000000

Setting DP - XXXXX.

00000.0

Setting DP - XXXX.x

0000.00

Setting DP - XXXX.xx

000.000

Setting DP - XXX.xxx

00.0000

Setting DP - XX.xxxx

0.00000

Setting DP - X.xxxxx

FLDR.P

Floating DP

6.2.3g Selection of projection of measuring units

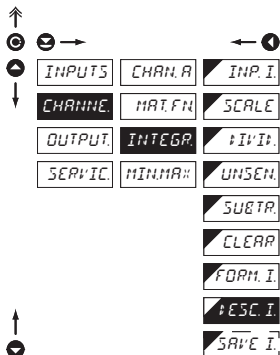
1

#ESC.I

Setting projection of descript. for Integrators

- projection of measured data may be extended (at the expense of the number of displayed places) by two characters for description
- description is set by shifted ASCII code, when two first places show the set description and two last characters their code in period 0...95
- description is cancelled by code 00

!

Table of signs on page 79

6.2.2h Selection of storing data into instrument memory

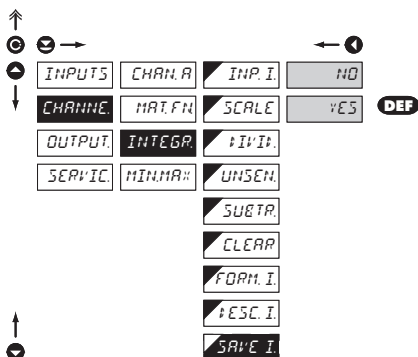
1

SAVE I.

Selection of storing data into instrument memory

- by selection in this item you allow to register values into instrument memory
- another setting in item "OUTPUT. > MEMORY" (not in standard experiment)

YES

Measured data are stored in the memory

NO

Measured data are not stored

6.2.4 Selection of evaluation of min/max value

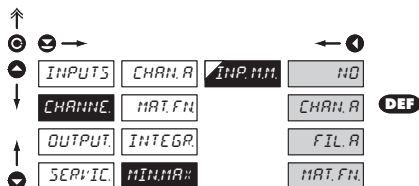
INP.MM. Selection of evaluation of min/max value

- selection of value from which the min/max value will be calculated

- NO** Evaluation of min/max value is off
- CHAN.A** From "Channel A"
- FIL.A** From "Channel A" after digital filters processing
- MAT.FN** From "Mathematic functions"

6.3 Setting „PROFI“ - OUTPUTS

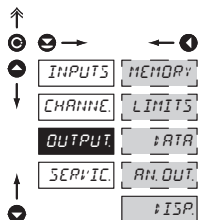

In this menu it is possible to set parameters of the instrument output signals

- MEMORY** Setting data logging into memory
- LIMITS** Setting type and parameters of limits
- DATA** Setting type and parameters of data output
- AN. OUT** Setting type and parameters of analog output
- DISP** Setting display projection and brightness

6.3.1a Selection of mode of data logging into instrument memory

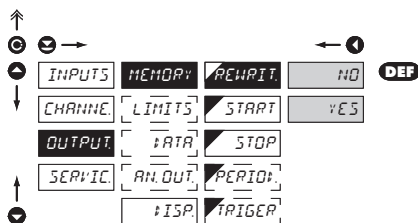

REWRIT Selection of the mode of data logging

- selection of the mode in the event of full instrument memory

- NO** Rewriting values prohibited
- YES** Rewriting values permitted, the oldest get rewritten by the latest

6.3.1b Setting data logging into instrument memory - RTC

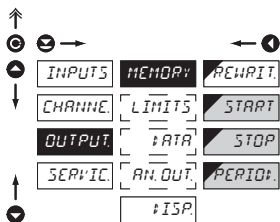

START Start of data logging into instrument memory

- time format HH.MM.SS

STOP Stop data logging into instrument memory

- time format HH.MM.SS

PERIOD Period of data logging into instrument memory

- determines the period in which values will be logged in an interval delimited by the time set under items START and STOP

- time format HH.MM.SS

- records are made on a daily basis in selected interval and period

- item not displayed if "STORE" is selected in menu (Input > EXT. IN.)

6.3.1c Setting data logging into instrument memory - FAST

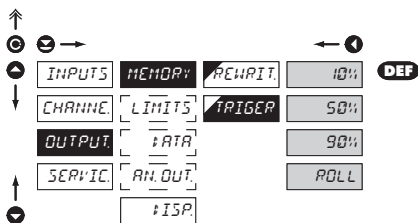

TRIGGER Setting logging data into inst. memory

- logging data into inst. memory is governed by the following selection, which determines how many percent of the memory is reserved for data logging prior to initiation of trigger impulse

- initiation is on ext. input or control key

10% Reser. of 10 % memory prior init. of data logging

50% Reser. of 50 % memory prior init. of data logging

90% Reser. of 90 % memory prior init. of data logging

PDL After initiation of data logging the memory is cyclically transcribed

6.3.2a Selection of input for limits evaluation

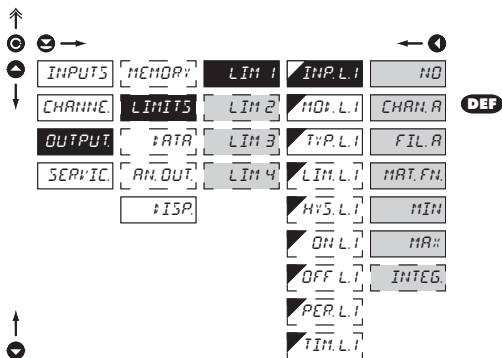

Setting is identical for LIM 2, LIM 3 and LIM 4

Selection evaluation of limits

- selection of value from which the limit will be evaluated

- Limit evaluation is off
- From "Channel A"
- From "Channel A" after digital filters processing
- From "Mathematic functions"
- From "Min. value"
- From "Max. value"
- From "Integrated value"

6.3.2b Selection of type of limit

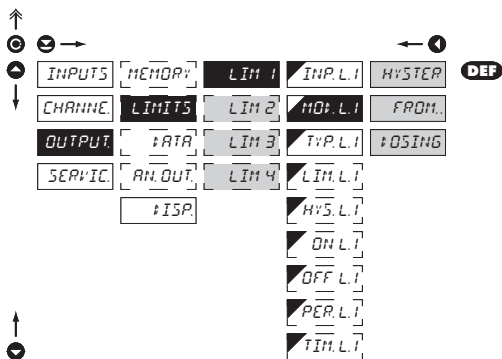

Setting is identical for LIM 2, LIM 3 and LIM 4

Selection the type of limit

- Limit is in mode "Limit, hysteresis, delay"
- for this mode the parameters of "UM. L." are set, at which the limit will shall react, "HYS. L." the hysteresis range around the limit ($LIM \pm 1/2 HYS$) and time "TIM. L." determining the delay of relay switch-on
- Frame limit
- for this mode the parameters are set for interval "ON. L." the relay switch-on and "OFF. L." the relay switch-off
- Dose limit (periodic)
- for this mode the parameters are set for "PER. L." determining the limit value as well as its multiples at which the output is active and "TIM. L." indicating the time during which is the output active

6.3.2c Selection of type of output

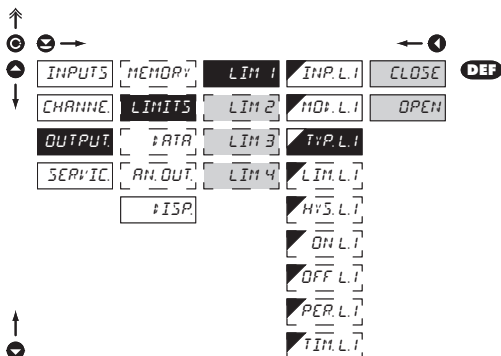

Typ. L.1 Selection of type of output

CLOSE Output switches on when condition is met

OPEN Output switches off when condition is met

!
Setting is identical for LIM 2, LIM 3 and LIM 4

6.3.2d Setting values for limits evaluation

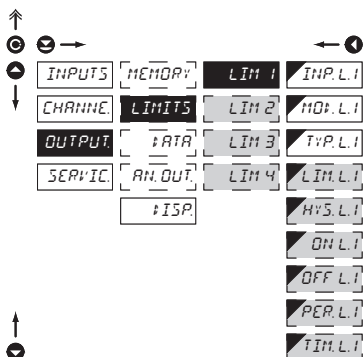

LIM. L.1 Setting limit for switch-on

- for type "HYSTER"

HYS. L.1 Setting hysteresis

- for type "HYSTER"

- indicates the range around the limit (in both directions, LIM. $\pm 1/2$ HYS.)

DN. L.1 Setting the outset of the interval of limit switch-on

- for type "FROM. ."

OFF. L.1 Setting the end of the interval of limit switch-on

- for type "FROM. ."

PER. L.1 Setting the period of limit switch-on

- for type "DOSING"

TIM. L.1 Setting the time switch-on of the limit

- for type "HYSTER" and "DOSING"

!
Setting is identical for LIM 2, LIM 3 and LIM 4

6.3.3a Selection of data output baud rate

INPUTS	MEMORY	ERAU	600
CHANNE	LIMITS	At:R	1200
OUTPUT	At:R	At:MO	2400
SERVIC	AN.OUT	PROT	4800
	At:ISP		9600
			19200
			38400
			57600
			115200
			230400

DEF

ERAU Selection of data output baud rate

600	Rate - 600 Baud
1200	Rate - 1 200 Baud
2400	Rate - 2 400 Baud
4800	Rate - 4 800 Baud
9600	Rate - 9 600 Baud
19200	Rate - 19 200 Baud
38400	Rate - 38 400 Baud
57600	Rate - 57 600 Baud
115200	Rate - 115 200 Baud
230400	Rate - 230 400 Baud

6.3.3b Setting instrument address

INPUTS	MEMORY	ERAU
CHANNE	LIMITS	At:R
OUTPUT	At:R	At:MO
SERVIC	AN.OUT	PROT
	At:ISP	

At:R Setting instrument address

- setting in range 0...31
- **DEF** = 00

At:MO Setting instrument address - MODBUS

- setting in range 1...247
- **DEF** = 1

6.3.3c Selection of data output protocol

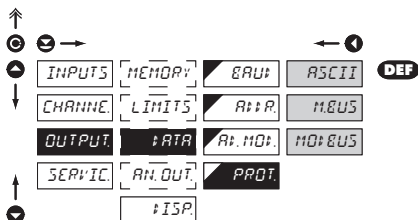

PROT. Selection of the type of analog output

- ASCII** Data protocol ASCII
- MEUS** Data protocol DIN MessBus
- MD:BUS** Data protocol MODBUS-RTU

- option is available only for RS 485

6.3.4a Selection of input for analog output

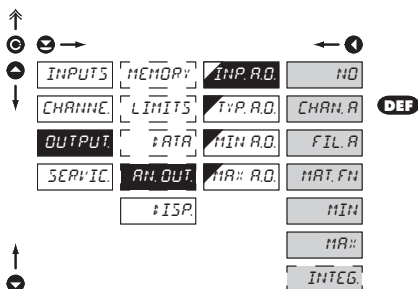

INP.AO. Selection evaluation analog output

- selection of value from which the analog output will be evaluated

- NO** AO evaluation is off
- CHAN.A** From "Channel A"
- FIL.A** From "Channel A" after digital filters processing
- MAT.FN** From "Math. functions"
- MIN.** From "Min. value"
- MAX.** From "Max. value"
- INTEG.** From "Integrated value"

6.3.4b Selection of the type of analog output

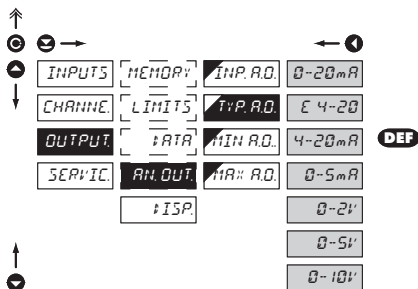

TYP.A.O. Selection of the type of analog output

0-20mA Type - 0...20 mA

4-20mA Type - 4...20 mA

- with indic. of error statement (<3,0 mA)

4-20mA Type - 4...20 mA

0-5mA Type - 0...5 mA

0-2V Type - 0...2 V

0-5V Type - 0...5 V

0-10V Type - 0...10 V

6.3.4c Setting the analog output range

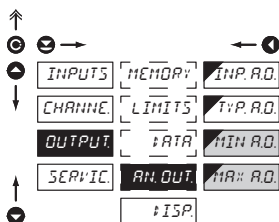

AN.OUT. Setting the analog output range

- analog output is isolated and its value corresponds with displayed data. It is fully programmable, i.e. it allows to assign the AO limit points to two arbitrary points of the entire measuring range

MIN.A.O. Assigning the display value to the beginning of the AO range

- range of the setting is -99999...999999

- **DEF** = 0

MAX.A.O. Assigning the display value to the end of the

AO range

- range of the setting is -99999...999999

- **DEF** = 100

6.3.5a Selection of input for display projection

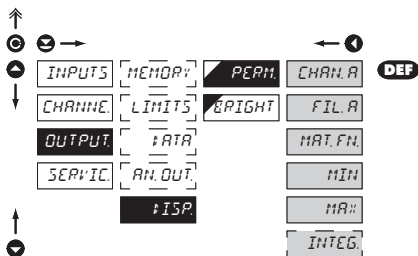

PERM. Selection display projection

- selection of value which will be shown on the instrument display

- CHAN.A** From "Channel A"
- FIL.A** From "Channel A" after digital filters processing
- MAT.FN** From "Math. functions"
- MIN** From "Min. value"
- MAX** From "Max. value"
- INTEG.** From "Integrated value"

6.3.5b Selection of display brightness

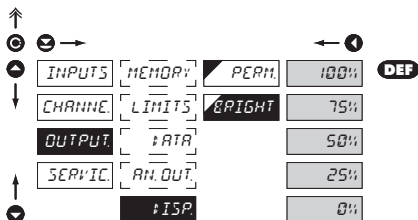

BRIGHT Selection of display brightness

- by selecting display brightness we may appropriately react to light conditions in place of instrument location

- 0%** Display is off
- 25%** Display brightness - 25%
- 50%** Display brightness - 50%
- 75%** Display brightness - 75%
- 100%** Display brightness - 100%

6.4 Setting "PROFI" - SERVICE

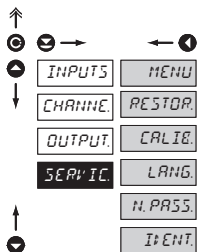

The instrument service functions are set in this menu

MENU	Selection of menu type LIGHT/PROFI
RESTOR.	Restore instrument manufacture setting and calibration
CALIB.	Automatic calibration of the input range
LANG.	Language version of instrument menu
H.PASS.	Setting new access password
IDENT.	Instrument identification

6.4.1 Selection of type of programming menu

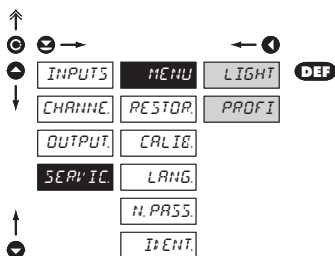

Change of setting is valid upon next access into menu

MENU Selection of menu type - LIGHT/PROFI

- enables setting the menu complexity according to user needs and skills

LIGHT Active LIGHT menu

- simple programming menu, contains only items necessary for configuration and instrument setting
- linear menu > items one after another

PROFI Active PROF I menu

- complete programming menu for expert users
- tree menu

6.4.2 Restoration of manufacture setting

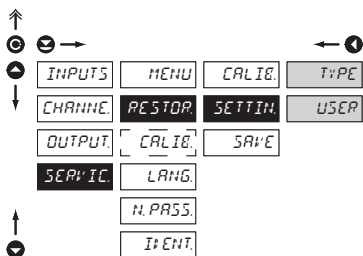
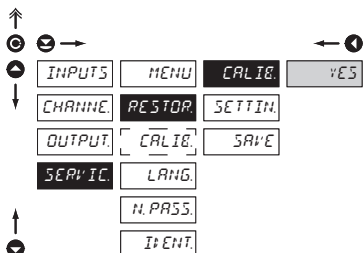

RESTOR. Restoration of manufacture setting

- in the event of error setting or calibration, manufacture setting may be restored.

CALIB. Restoration of manufacture calibration of the instrument

- prior executing the changes you will be asked to confirm your selection „YES“

SETTIN. Restoration of instrument manufacture setting

TYPE Restoration of instrument manufacture setting

- generating the manufacture setting for currently selected type of instrument (items marked DEF)

USER Restoration of instrument user setting

- generating the instrument user setting, i.e. setting stored under SERVIC./RESTOR./SAVE

SAVE Save instrument user setting

- storing the user setting allows the operator to restore it in future if needed

Jobs performed	Restore	
	Calibration	Setting
cancels USER menu rights	✓	✓
deletes table of items order in USER - LIGHT menu	✓	✓
adds items from manufacture to LIGHT menu	✓	✓
deletes data stored in FLASH	✓	✓
cancels or linearization tables	✓	✓
clears tare	✓	✓
clears conduct resistances	✓	✓
restore manufacture calibration	✓	x
restore manufacture setting	x	✓

!
After restoration the instrument switches off for couple seconds

6.4.3 Calibration - Input range

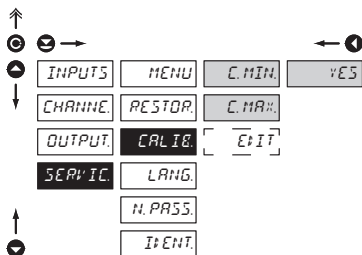
CALIB. Input range calibration

- prior performing any changes you will be asked to confirm your selection "YES"

C. MIN. Calibration of the beginning of the measuring range

- prior confirmation of the selection the reference signal has to be connected

C. MAX. Calibration of the end of the measuring range

- prior confirmation of the selection the reference signal has to be connected



After incorrect client calibration it is always possible to restore manufacture calibration ("SERVIC./RESTOR./CALIB.")

Manual calibration:

MAX Sensor range

SENSE Sensor sensitivity

Automatic calibration

(after calibration in menu "SERVIC./CALIB."):

MIN Size of load with which minimum calibration was performed

MAX Size of load with which maximum calibration was performed

- upon maximum calibration we recommend the reference load value in the upper third of the measuring range

6.4.3a Calibration - modification of internal constants

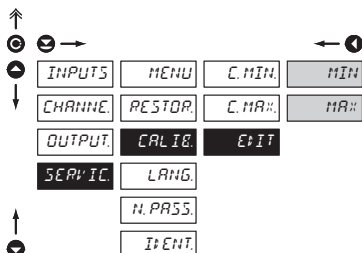
EDIT Modification of internal calibration constants

- this option is designed solely for contingent metrological examination and protocol

- item is available after aut. calibration

MIN Minimum calibration range

- range ± 99.0000

MAX Maximum calibration range

- range ± 99.0000

6.4.4 Selection of instrument menu language version

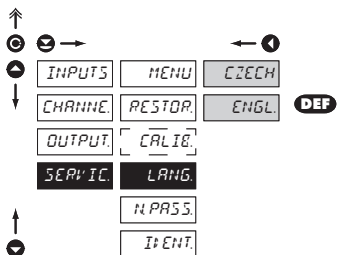

LANG. Selection of instrument menu language version

CZECH Instrument menu is in Czech

ENGL. Instrument menu is in English

6.4.5 Setting new access password

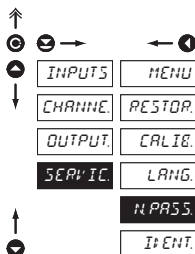

N.PASS. Setting new password for access to LIGHT and PROFIL menu

- this selection enables changing number code that blocks the access into LIGHT and PROFIL Menu.
- range of the number code is 0...9999
- universal password in the event of loss is „8177”

6.4.6 Instrument identification

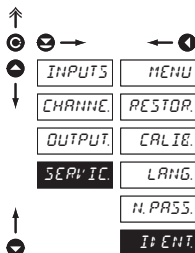

I+ENT. Projection of instrument SW version

- display shows type identification of the instrument, SW number, SW version and current input setting (Mode)
- if the SW version reads a letter on first position, it is a customer SW

7.0 Setting items into "USER" menu

- **USER** menu is designed for users who need to change only several items of the setting without the option to change the primary instrument setting (e.g. repeated change of limit setting)
- there are no items from manufacture permitted in **USER** menu
- on items indicated by inverse triangle  L i
- setting may be performed in **LIGHT** or **PROFI** menu, with the **USER** menu then overtaking the given menu structure

Setting

USER



- For user operation
- Menu items are set by the user (Profi/Light) as per request
- Access is not password protected

Setting

flashing legend - current setting is displayed



NO item will not be displayed in USER menu

YES item will be displayed in USER menu with editing option

SHOW item will be solely displayed in USER menu

Setting sequence of items in "USER" menu

In compiling USER menu from active LIGHT menu the items (max. 10) may be assigned a sequence, in which they will be projected in the menu



Example:

Into USER menu were selected these items

(keys $\ominus + \oplus$) > CL. TAR., LIM 1, LIM 2, LIM 3, for which we have preset this sequence (keys $\ominus + \omin�$):

CL. TAR.	5
LIM 1	0 (sequence not determined)
LIM 2	2
LIM 3	1

Upon entering USER menu

(key $\omin�$) items will be projected in the following sequence: LIM 3 > LIM 2 > CL.TAR. > LIM 1

The instruments communicate via serial line RS232 or RS485. For communication they use the ASCII protocol. Communication runs in the following format:

ASCII: 8 bit, no parity, one stop bit
 DIN MessBus: 7 bit, even parity, one stop bit

The transfer rate is adjustable in the instrument menu. The instrument address is set in the instrument menu in the range of 0 ÷ 31. The manufacture setting always presets the ASCII protocol, rate of 9600 Baud, address 00. The type of line used - RS232 / RS485 - is determined by an output board automatically identified by the instrument.

The commands are described in specifications you can find at [na www.orbit.merret.cz/rs](http://na.www.orbit.merret.cz/rs) or in the OM Link program.

DETAILED DESCRIPTION OF COMMUNICATION VIA SERIAL LINE

Event	Type	Protocol	Transmitted data																	
Data solicitation (PC)	232	ASCII	#	A	A	<CR>														
		MessBus	No - data is transmitted permanently																	
	485	ASCII	#	A	A	<CR>														
		MessBus	<SADR>	<ENQ>																
Data transmission (instrument)	232	ASCII	>	D	(D)	(D)	(D)	(D)	(D)	(D)	(D)	(D)	(D)	(D)	(D)	(D)	(D)	<CR>		
		MessBus	<SADR>	D	(D)	(D)	(D)	(D)	(D)	(D)	(D)	(D)	(D)	(D)	(D)	(D)	(D)	(D)	<ETX>	<BCC>
	485	ASCII	>	D	(D)	(D)	(D)	(D)	(D)	(D)	(D)	(D)	(D)	(D)	(D)	(D)	(D)	<CR>		
		MessBus	<SADR>	D	(D)	(D)	(D)	(D)	(D)	(D)	(D)	(D)	(D)	(D)	(D)	(D)	(D)	<ETX>	<BCC>	
Confirmation of data acceptance (PC) - OK	485	MessBus	<DLE>	1																
Confirmation of data acceptance (PC) - Bad			<NAK>																	
Sending address (PC) prior command			<EADR>	<ENQ>																
Confirmation of address (instrument)			<SADR>	<ENQ>																
Command transmission (PC)	232	ASCII	#	A	A	N	P	(D)	(D)	(D)	(D)	(D)	(D)	(D)	(D)	(D)	<CR>			
		MessBus	<STX>	\$	N	P	(D)	(D)	(D)	(D)	(D)	(D)	(D)	(D)	(D)	<ETX>	<BCC>			
	485	ASCII	#	A	A	N	P	(D)	(D)	(D)	(D)	(D)	(D)	(D)	(D)	(D)	<CR>			
		MessBus	<SADR>	\$	N	P	(D)	(D)	(D)	(D)	(D)	(D)	(D)	(D)	(D)	<ETX>	<BCC>			
Command confirmation (instrument)	232	ASCII	OK	!	A	A	<CR>													
			Bad	?	A	A	<CR>													
		MessBus	No - data is transmitted permanently																	
	485	ASCII	OK	!	A	A	<CR>													
			Bad	?	A	A	<CR>													
		MessBus	OK	<DLE>	1															
			Bad	<NAK>																
Command confirmation (inst.) - OK	485	MessBus	!	A	A	<CR>														
?			A	A	<CR>															
Instrument identification			#	A	A	1Y	<CR>													
HW identification			#	A	A	1Z	<CR>													
One-time transmission			#	A	A	7X	<CR>													
Repeated transmission			#	A	A	8X	<CR>													

LEGEND

#	35	23 _H	Command beginning
A	A	0...31	Two characters of instrument address (sent in ASCII - tens and units, e.g. "01", "99" universal
<CR>	13	0D _H	Carriage return
<SP>	32	20 _H	Space
N, P			Number and command - command code
D			Data - usually characters "0"... "9", ".", "-", ";", (D) - dp. and (-) may prolong data
R	30 _H ...3F _H		Relay and tare status
!	33	21 _H	Positive confirmation of command (ok)
?	63	3F _H	Negative confirmation of command (point)
>	62	3E _H	Beginning of transmitted data
<STX>	2	02 _H	Beginning of text
<ETX>	3	03 _H	End of text
<SADR>	address +60 _H		Prompt to send from address
<EADR>	address +40 _H		Prompt to accept command at address
<ENQ>	5	05 _H	Terminate address
<DLE>1	16 49	10 _H 31 _H	Confirm correct statement
<NAK>	21	15 _H	Confirm error statement
<BCC>			Check sum -XOR

RELAY, TARE

Sign	Relay 1	Relay 2	Tare	Change relay 3/4
P	0	0	0	0
Q	1	0	0	0
R	0	1	0	0
S	1	1	0	0
T	0	0	1	0
U	1	0	1	0
V	0	1	1	0
W	1	1	1	0
p	0	0	0	1
q	1	0	0	1
r	0	1	0	1
s	1	1	0	1
t	0	0	1	1
u	1	0	1	1
v	0	1	1	1
w	1	1	1	1

Relay status is generated by command #AA6X <CR>.

The instrument immediately returns the value in the format >HH <CR>, where HH is value in HEX format and range 00_H...FF_H. The lowest bit stands for „Relay 1“, the highest for „Relay 8“

ERROR	CAUSE	ELIMINATION
<i>E. I. U_n</i>	Number is too small (large negative) to be displayed	change DP setting, channel constant setting
<i>E. I. O_r</i>	Number is too large to be displayed	change DP setting, channel constant setting
<i>E. T. U_n</i>	Number is outside the table range	increase table values, change input setting (channel constant setting)
<i>E. T. O_r</i>	Number is outside the table range	increase table values, change input setting (channel constant setting)
<i>E. I. U_n</i>	Input quantity is smaller than permitted input quantity range	change input signal value or input (range) setting
<i>E. I. O_r</i>	Input quantity is larger than permitted input quantity range	change input signal value or input (range) setting
<i>E. HW</i>	A part of the instrument does not work properly	send the instrument for repair
<i>E. EE</i>	Data in EEPROM corrupted	perform restoration of manufacture setting, upon repeated error statement send instrument for repair
<i>E. I. ATA</i>	Data in EEPROM outside the range	perform restoration of manufacture setting, upon repeated error statement send instrument for repair
<i>E. CLR</i>	Memory was empty (presetting carried out)	upon repeated error statement send instrument for repair, possible failure in calibration

The instrument allows to add two descriptive characters to the classic numeric formats (at the expense of the number of displayed places). The setting is performed by means of a shifted ASCII code. Upon modification the first two places display the entered characters and the last two places the code of the relevant symbol from 0 to 95. Numeric value of given character equals the sum of the numbers on both axes of the table.

Description is cancelled by entering characters with code 00

	0	1	2	3	4	5	6	7		0	1	2	3	4	5	6	7	
0		7	"	#	\$	%	&	'		0	!	"	#	\$	%	&	'	
8	:)	*	+	,	-	.	/		8	()	*	+	,	-	.	/
16	0	1	2	3	4	5	6	7		16	0	1	2	3	4	5	6	7
24	8	9	:	"	'	-	.	7		24	8	9	:	;	<	=	>	?
32	P	R	E	C	T	E	F	G		32	@	A	B	C	D	E	F	G
40	H	I	J	K	L	M	N	O		40	H	I	J	K	L	M	N	O
48	P	Q	R	S	T	U	V	W		48	P	Q	R	S	T	U	V	W
56	X	Y	Z	[\]	^	_		56	X	Y	Z	[\]	^	_
64	`	a	b	c	d	e	f	g		64	`	a	b	c	d	e	f	g
72	h	i	j	k	l	m	n	o		72	h	i	j	k	l	m	n	o
80	p	q	r	s	t	u	v	w		80	p	q	r	s	t	u	v	w
88	x	y	z	{		}	~			88	x	y	z	{		}	~	

INPUT

range is fixed, as per order

Range:	±99,999 mV	>1,8 MOhm
	±999,99 mV	1,8 MOhm
	±9,9999 V	1,8 MOhm
	±99,999 V	1,8 MOhm
	±300,00 V	1,8 MOhm
	±999,99 mA	< 300 mV
	±9,9999 mA	< 300 mV
	±99,999 mA	< 300 mV
	±999,99 mA	< 50 mV
	±5,0000 A	< 50 mV

range is adjustable

0...5 mA	< 300 mV
0...20 mA	< 300 mV
4...20 mA	< 300 mV
±2 V	1,8 MOhm
±5 V	1,8 MOhm
±10 V	1,8 MOhm

Number of inputs: 2, two inputs I and U are set as a standard

range is adjustable

0...5 mA	< 300 mV
0...20 mA	< 300 mV
4...20 mA	< 300 mV
±2 V	1,8 MOhm
±5 V	1,8 MOhm
±10 V	1,8 MOhm

Number of inputs: 2, two inputs I and U are set as a standard

Time base:

1 s

Projection:

immediate (±99999)
acrued (999999)

range is adjustable

0...5 mA	< 300 mV
0...20 mA	< 300 mV
4...20 mA	< 300 mV
±2 V	1,8 MOhm
±5 V	1,8 MOhm
±10 V	1,8 MOhm

Number of inputs: 2, two inputs I and U are set as a standard

Linearization: linear interpolation in 256 points

Number of tables: 16

Voltage of lin. pot.

2,5 VDC/6 mA
min. potentiometer resistance is 500 Ohm**DC**

Input U

Input U

Input U

Input U

Input U

Input I

Input I

Input I

Input I

Input I

Input I

PM

Input I

Input I

Input I

Input U

Input U

Input U

I

Input I

Input I

Input I

Input U

Input U

Input U

LX

Input I

Input I

Input I

Input U

Input U

Input U

DU

range is fixed, as per order

Sensitiveness: 1...4 mV/V

2...8 mV/V

4...16 mV/V

Connection: 4/6-wire

Tensimeter voltage: 10 VDC, max. load 65 Ohm

PROJECTIONDisplay: 999999, intensive red or green
14-fi segment LED, digit height 14 mm

Projection: ±99999 (-99999...999999)

Decimal point: adjustable - in menu

Brightness: adjustale - in menu

INSTRUMENT ACCURACY

TC: 60 ppm/°C

Accuracy: ±0,05 % of range + 1 digit

±0,1 % of range + 1 digit

DU, T

Above accuracies apply for projection 99999

Rate: 0,1...100 measurements/s

Overload capacity: 10x (t < 100 ms) not for 400 V and 5 A,

2x (long-term)

Linearisation: by linear interpolation in 50 points

- solely via OM Link

Digital filters: Averaging, Floating average, Exponential filter, Rounding

Functions: Tare - display resetting

Hold - stop measuring (at contact)

Lock - control key locking

MM - min/max value

Mathematic functions

OM Link: company communication interface for setting,

operation and update of instrument SW

Watch-dog: reset after 400 ms

Calibration: at 25°C and 40 % of r.h.

COMPARATOR

Type: digital, adjustable in menu

Mode: Hysteresis, From, Dose

Limits: -99999...999999

Hysteresis: 0...999999

Delay: 0...99,9 s

Outputs: 2x relays with switch-on contact (Form A)

(230 VAC/30 VDC, 3 A)*

2x relays with switch-off contact (Form C)

(230 VAC/50 VDC, 3 A)*

2x SSR (250 VAC/ 1 A)*

2x/4x open collector (30 VDC/100 mA)

2x bistabil relays (250 VAC/250 VDC, 3 A/0,3 A)*

Relay: 1/8 HP 277 VAC, 1/10 HP 125 V, Pilot Duty D300

* values apply for resistance load

DATA OUTPUTS

Protocols:	ASCII, DIN MessBus, MODBUS, PROBUS
Data format:	8 bit + no parity + 1 stop bit (ASCII) 7 bit + even parity + 1 stop bit (MessBus)
Rate:	600...230 400 Baud
RS 232:	isolated, two-way communication
RS 485:	isolated, two-way communication, addressing (max. 31 instruments)
PROFIBUS	Data protocol SIEMENS

ANALOGO OUTPUTS

Type:	isolated, programmable with resolution of max.10 000 points, analog output corresponds with displayed data, type and range are adjustable
Non-linearity:	0,2% of range
TC:	100 ppm/°C
Rate:	response to change of value < 150 ms
Voltage:	0...2 V/5 V/10 V
Current:	0...5/20 mA/4...20 mA - compensation of conduct to 500 Ohm/12 V or 1 000 Ohm/24 V

MEASURED DATA RECORD

Type RTC:	time-controlled logging of measured data into instrument memory, allows to log up to 250 000 values
Type FAST:	fast data logging into instrument memory, allows to log up to 8 000 values at a rate of 40 records/s
Transmission:	via data output RS 232/485 or via OM Link

EXCITATION

Adjustable:	5...24 VDC/max. 1,2 W, isolated
-------------	---------------------------------

POWER SUPPLY

Options:	10...30 V AC/DC, 10 VA, isolated, - fuse inside (T 4000 mA) 80...250 V AC/DC, 10 VA, isolated - fuse inside (T 630 mA)
----------	---

MECHANIC PROPERTIES

Material:	Noryl GFN2 SE1, incombustible UL 94 V-1
Dimensions:	96 x 48 x 120 mm
Panel cut-out:	90,5 x 45 mm

OPERATING CONDITIONS

Connection:	connector terminal board, conductor cross-section <1,5 mm ² /<2,5 mm ²
Stabilisation period:	within 15 minutes after switch-on
Working temp.:	0°...60°C
Storage temp.:	-10°...85°C
Cover:	IP65 (front panel only)
Construction:	safety class I
Overvoltage category:	EN 61010-1, A2
Insulation resistance:	for pollution degree II, measurement category III instrum.power supply > 670 V (PI), 300 V (DI) Input/output > 300 V (PI), 150 (DI)
EMC:	EN 61000-3-2+A12; EN 61000-4-2, 3, 4, 5, 8, 11; EN 550222, A1, A2

Front view



Panel cut

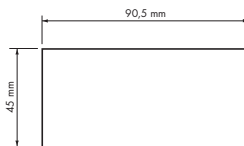

Side view

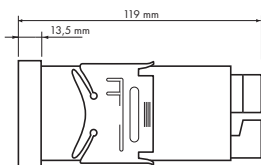

Panel thickness: 0,5...20 mm

Instrument installation

1. insert the instrument into the panel cut-out
2. fit both travellers on the box
3. press the travellers close to the panel

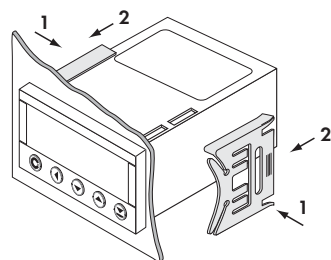
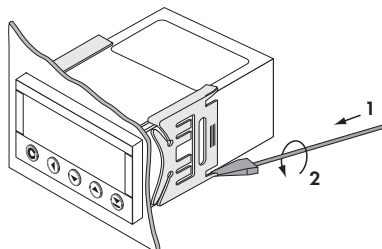

Instrument disassembly

1. slide a screw driver under the traveller wing
2. turn the screw driver and remove the traveller
3. take the instrument out of the panel

Product **OM 502** DC PM I LX DU T
 Type
 Manufacturing No.
 Date of sale

GUARANTEE

A guarantee period of 60 months from the date of sale to the user applies to this instrument.
 Defects occurring during this period due to manufacture error or due to material faults shall be eliminated free of charge.

For quality, function and construction of the instrument the guarantee shall apply provided that the instrument was connected and used in compliance with the instructions for use.

The guarantee shall not apply to defects caused by:

- mechanic damage
- transportation
- intervention of unqualified person incl. the user
- unavoidable event
- other unprofessional interventions

The manufacturer performs guarantee and post.guarantee repairs unless provided for otherwise.



Y E A R S

Stamp, signature

DECLARATION OF CONFORMITY

Company: **ORBIT MERRET, spol. s r.o.**
Klánska 81/141, 142 00 Prague 4, Czech Republic, IDNo: 00551309

Manufactured: **ORBIT MERRET, spol. s r.o.**
Vodňanská 675/30, 198 00 Prague 9, Czech Republic

declares at its full responsibility that the product presented hereunder meets all technical requirements, is safe for use when utilised under the terms and conditions determined by ORBIT MERRET, spol.s r.o. and that our company has taken all measures to ensure conformity of all products of the type listed hereunder, which are being brought out to the market, with technical documentation and requirements of the appurtenant statutory orders.

Product: 5-digit programmable panel instrument

Type: **OM 502**

Version: DC, PM, I, LX, DU, T

Conformity is assessed pursuant to the following standards:

El. safety:	EN 61010-1
EMC:	EN 50131-1, chapter 14 and chapter 15
	EN 50130-4, chapter 7
	EN 50130-4, chapter 8
	EN 50130-4, chapter 9
	EN 50130-4, chapter 10
	EN 50130-4, chapter 11
	EN 50130-4, chapter 12
	EN 50130-4, chapter 13
	EN 50130-5, chapter 20
	prEN 50131-2-1, par. 9.3.1
	EN 61000-4-8
	EN 61000-4-9
	EN 61000-3-2 ed. 2:2001
	EN 61000-3-3: 1997, Cor. 1:1998, Z1:2002
	EN 55022, chapter 5 and chapter 6

and Ordinance on:

El. safety:	No. 168/1997 Coll.
EMC:	No. 169/1997 Coll.

The evidence are the protocols of authorized and accredited organizations:

VTÚE Praha, experimental laboratory No. 1158, accredited by ČIA
VTÚPV Vyškov, experimental laboratory No. 1103, accredited by ČIA

Place and date of issue: Prague, 18. April 2006

Miroslav Hackl v.r.
Company representative

Mode of asses. of conformity §12, par. 4 b, d Act No. 22/1997 Coll.