

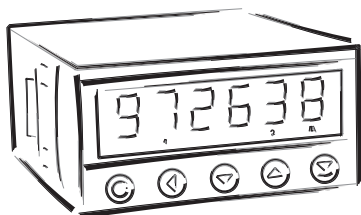

OM 651 UC

6 DIGIT PROGRAMMABLE

IMPULSE COUNTER
FREQUENCYMETER
STOP-WATCH/WATCH



SAFETY INSTRUCTIONS

Please, read the enclosed safety instructions carefully and observe them!
These instruments should be safeguarded by isolated or common fuses (breakers)!
For safety information the EN 61 010-1 + A2 standard must be observed.
This instrument is not explosion-safe!

TECHNICAL DATA

Measuring instruments of the OM 651 series conform to European regulation 89/336/EWG and Ordinance 168/1997 Coll.

They are up to the following European and Czech standards:
CSN EN 55 022, class B
CSN EN 61000-4-2, -4, -5, -6, -8, -9, -10, -11

The instruments are applicable for unlimited use in agricultural and industrial areas.

CONNECTION

Power supply from the main line has to be isolated from the measuring leads.



ORBIT MERRET, spol. s r.o.

Vodnanská 675/30
198 00 Prague 9

Tel: +420 - 281 040 200

Fax: +420 - 281 040 299

e-mail: orbit@merret.cz

www.orbit.merret.cz



1. CONTENTS

1. Contents	3
2. Instrument description	4
3. Connection	6
4. Instrument setting	8
setting the decimal point and the minus sign	9
access into the configuration mode	9
4.1 Minimum Instrument setting	10
4.2 User menu	11
4.2.1 Limits - entering values	11
4.2.2 Setting the display brightness	11
4.3 Configuration menu	12
4.3.1 Configuration mode - iINPUTS	13
4.3.1.1 Resetting the counter	13
4.3.1.2 Instrument configuration	14
4.3.1.2.1 Setting the measuring mode	14
4.3.1.2.2 Setting the measuring time/time base	14
4.3.1.2.3 Setting the input filter parameters	15
4.3.1.2.4 Setting the display status backup	15
4.3.1.2.5 Time setting	15
4.3.1.2.6 Setting the Stop-watch/watch control	16
4.3.1.2.7 Setting the stop-watch/watch control - Resetting	16
4.3.1.2.8 Setting the display status backup	16
4.3.1.3 Setting the auxiliary input	17
4.3.1.4 Permission to reset by the enter key	17
4.3.2 Configuration mode - CHANNELS	18
4.3.2.1 Setting the calibration constant	18
4.3.2.2 Offset setting	18
4.3.2.3 Measured value rounding	19
4.3.2.4 Projection format	19
4.3.3 Configuration mode - OUTPUT	20
4.3.3.1.1 Limits - setting the relay mode	20
4.3.3.1.2 Limits - setting the boundaries	20
4.3.3.2.1 Data output - setting the transmission rate	21
4.3.3.2.2 Data output - setting the instrument address	21
4.3.3.3.1 Analog output - setting the type	21
4.3.3.3.2 Analog output - setting the range	22
4.3.3.3.3 Setting the display brightness	22
4.3.4 Configuration mode - SERVICE	23
4.3.4.1 Setting the access rights for „User mode“ - limits	23
4.3.4.2 Return to manufacture calibration/setting	24
4.3.4.3 Setting new access password	24
4.3.4.4 Instrument identification	24
5. Data protocol	25
6. Error statements	26
7. Technical data	29
8. Instrument dimensions and instal.	30
9. Certificate of guarantee	31
Declaration of conformity	32

2. INSTRUMENT DESCRIPTION

DESCRIPTION

The OM 651UC model is a universal 6 digit programmable panel impulse counter/frequency meter and stop-watch/watch. The instrument is based on an 8-bit microprocessor, that secures high accuracy, stability and easy operation of the instrument.

Measuring modes

COUNTER	Single-channel counter
FREQUENCY	Frequency meter
STOPWATCH	Stopwatch
WATCH	Watch

C-F

C-F

H

H

Programmable display projection

Calibration	calibration coefficient may be set in „CM“
Projection	-99999...999999 with fixed DP, for measuring modes STOPWATCH/WATCH with option of setting in format 10/24/60
Time base:	0,5/1/2/5/10 s

Digital filters

Input filter:	the instrument allows to filter the input signal and thus suppress undesirable interfering signals (e.g. relay back-swings). The set parameter indicates maximum possible measured frequency, that the instrument will process, 5/40/100/200 Hz
Radius of insensitiveness	adjustable in digits

Functions

Preset	initial non-zero value which is read always after instrument resetting
Rounding	setting the projection step for the display
OM Link	company interface for instrument control, setting and update

External control

Hold	display/instrument/menu access locking
Lock	control keys locking
Resetting	resetting to zero/presetting the counter

OPERATION

The instrument is set and controlled by five control keys located on the front panel. All programmable settings of the instrument are realised in two adjusting modes:

Configuration menu	(hereinafter referred to as „CM“) is protected by an optional numeric code and contains complete instrument setting
User menu	may contain arbitrary programming setting defined in CM with another selective restriction (see, change)

All programmable parameters are stored in the EEPROM memory (they hold even after the instrument is switched off).

EXTENSION

Comparators are assigned to control two limit values with relay output. The limits have adjustable hysteresis within the full display range as well as selectable delay of the switch-on in the range 0...99,9 s. Reaching the preset limits is signalled by LED and by the switch-on of relevant relay.

Excitation is suitable for feeding sensors. It has a galvanic isolation with fixed value of 15 VDC.

Data outputs are for their rate and accuracy suitable for transmission of measured data for further projection or directly into the control systems. We offer isolated RS232 and RS485 with the ASCII protocol.

Analog outputs will find their place in applications where further evaluating or processing of measured data in external devices is required. We offer universal analog output with the option of selection of the output type - voltage/current. The analog output value corresponds with the displayed data and its type and range are selectable in the programming mode.

Time back-up by the RTC circuit is designed for the „WATCH“ measuring mode and secures time measurement even when the instrument is switched off (without projection on the display).

FIRMWARE

www.orbit.merret.cz/update

Considering the continuous development and innovation of our products it is now possible to download the most recent program version for every instrument directly from web pages. To install the program, the HW programmer Flash Nec has to be used.

Prior performing the update it is possible to store all instrument settings and to restore all setting to initial status after the programming has been completed.

Number of the current program version in your instrument you can find in the „Configuration menu - service - identification“

! *The function for recording the new Firmware is supported in all instruments from version 060*

3. CONNECTION

The supply lead for feeding the instrument should not be in the proximity of low-potential input signals.

Contactors, motors with larger input and other efficient elements should not be in the proximity of the instrument.

The lead into the instrument input (the measured quantity) should be in sufficient distance from all power leads and appliances. Provided this cannot be secured, it is necessary to use shielded leads and connect correctly (only on one side) to ground terminal GND (No.13) .

The instruments are tested in compliance with standards for use in industrial area, yet, we recommend to abide by the above mentioned principles.

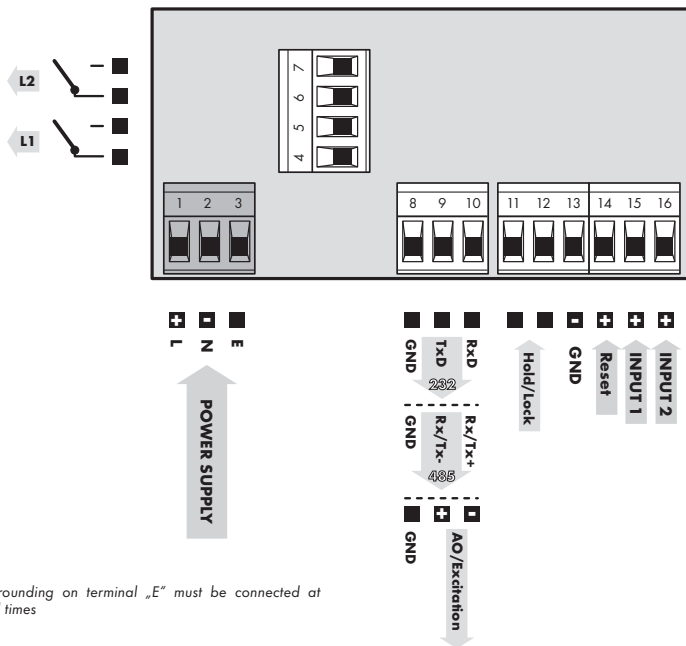



CONNECTION

	Description	wiring
Input 1	input signal < 60 V	GND + Input 1
Input 2	input signal < 300 V	GND + Input 2
Resetting	input signal < 60 V	GND + Resetting

Function	Description	Control
Hold	Instrument blocking (adjustable in the menu)	upon contact, terminal (No. 11/12)
Lock	Keyboard locking	upon contact, terminal (No. 11/12)

3.1 CONFIGURATION OF JUMPERS

Setting the comparator levels

- 1  **J1 - Input 1/2**
 2  **J2 - Reset**

 For settings see table
- 3  **J3 - Battery**

 Connection battery for time backup
- 4  **J4 - Programming conector**

 Service function
- 5 

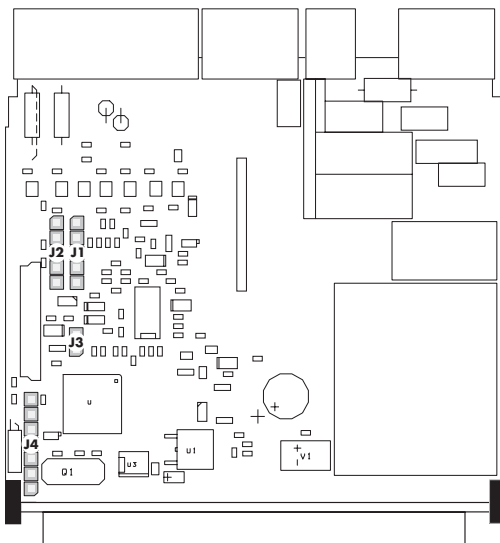

Jumpers J1, J2	Type of input	Input voltage	Comparator levels - Input 1*		Comparator levels - Input 2*	
			L > H	H > L	L > H	H > L
1 - 2	NPN, Contact	xxx	0,5 V	4,5 V	Prohibited	Prohibited
bez	TTL (PNP)	3 - 7,5 V	0,5 V	4,5 V	Prohibited	Prohibited
3 - 4	PNP	15 - 60 V	3,3 V	30 V	20 V	180 V
4 - 5	PNP	7,5 - 15 V	1,9 V	17 V	10 V	92 V
2 - 3	!!! DO NOT CONNECT !!!					

*values guaranteed in full temperature range of the instrument operation

! For each jumper setting disconnect the instrument from the net

! Relay parameters specified in the technical data apply for resistance load. Upon connection of the induction load we recommend to fit the leads to relay 1 A with a fuse for maximum load protection.

4. INSTRUMENT SETTING

The instrument is set and controlled by 5 control keys located on the front panel. By means of these control keys it is possible to browse through the operating program, to select and set the required values.

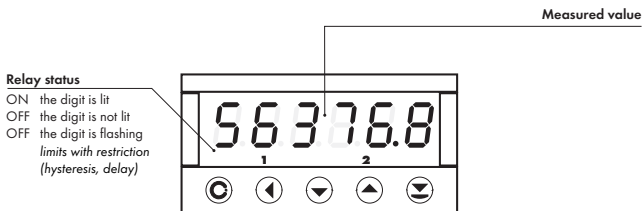

CONFIGURATION MODE

- designated for professional service and maintenance
- complete instrument setting
- access is password protected
- authorization for "User mode"

USER MODE

- designated for instrument service
- may contain setting the limits, analog and data output and brightness, with restriction as per the setting in "Configuration mode"

SYMBOLS USED IN THE INSTRUCTIONS

DEF Items indicated this way are preset from manufacture

C-F H Indicates the setting for given type of instrument

CONTROL KEYS FUNCTIONS

MENU	ENTER	LEFT	DOWN	UP
Measuring mode				
menu access				
Moving around in the menu				
exit menu without saving	move to next level	back to previous level		move to next item
Setting/selecting - items				
cancel setting without saving	confirm selected item		move down	move up
Setting - numbers				
cancel setting without saving	confirm selected number	move to higher decade	change of current figure - down -	change of current figure - up -

SETTING THE DECIMAL POINT AND THE MINUS SIGN

DECIMAL POINT

Upon modification of the edited number in the menu the decimal point is set by key with transition beyond the highest decade, when the decimal point starts flashing. Positioning is performed by , and confirmation by with return into number editing.

Decimal point for display projection is set in item „CHANNEL > FORMAT“ by selection from preset values.

MINUS SIGN

Setting the minus sign is performed on the highest valid degree by key /.

The minus sign is in numeric row (0, 1, 2, 3...9, -).



Setting

- ⇒ after transition beyond the highest decade the decimal point starts flashing
- ⇒ by pressing you will place the DP and confirm by

ACCESS INTO THE CONFIGURATION MODE

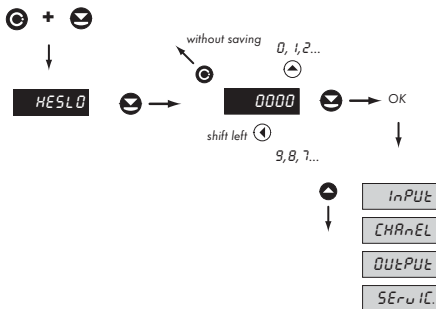

The code is always preset from manufacture to 0000. In case of loss of access password it is possible to use universal access code "8177"

4.1 MINIMUM INSTRUMENT SETTING

All settings are performed in the „Configuration menu“

1 Selecting the measuring mode



MODE Setting the instrument measuring mode

COUNT Impulse counter

- measures at Input 1 or 2

FREQ. Frequency meter

- measures frequency at Input 1 or 2

! In "Mode 2" (stopwatch/watch) this item is not visible according to the order code

2 Setting display projection

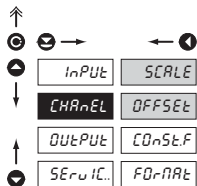

SCALE Setting basic channel parameters

SCALE Calibration constant

- calibration constant is for the conversion of input value to required display value
 - by setting the minus value the direction of counting changes, i.e. we count down
 - range: -0,00001...999999

- **DEF** = 1

OFFSET Additive constant, PRESET"

- shifting the beginning of measurement by a set value which will always be read upon resetting the instrument to zero
 - range: -99999...999999

- **DEF** = 0

4.2 USER MENU

- designated for instrument service
- may contain setting the limits and brightness, with restriction as per the setting in "Configuration mode"

236



OUTPUT

LIMIT

Setting
the limits,
hysteresis and
delay

OUTPUT

Setting the instrument outputs

4.2.1 LIMITS - ENTERING VALUES

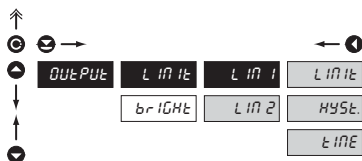

LIMIT - Entering limit values for status evaluations

LIMIT Setting limit for relay switch-on

- in full display range

HYS Setting hysteresis only in (+) values

- in 1/10 of the display range

TIME Setting delayed switch-on of the limit

- in range 0...99,9 s

Adjustable authorization of access into items, see page 20

4.2.2 SETTING THE DISPLAY BRIGHTNESS

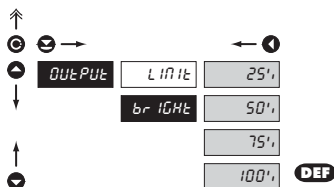

BRIGHT Setting the display brightness

25% Brightness 25%

50% Brightness 50%

75% Brightness 75%

100% Brightness 100%

4.3 CONFIGURATION MENU

- designated for professional service and maintenance
- complete instrument setting
- access is password protected
- authorization for "User mode"

23.6



PASS_u

0000

Entering the access password

INPUT	CLr.L	CONF IG	AUH InP	KEYS
--------------	--------------	----------------	----------------	-------------

Internal values
resettingBasic
instrument
settingSetting the
Hold/Lock
functionKeys function
permitted

INPUT
Setting the instrument input

CHANEL	SCALE	OFFSEt	rouNd	FOrMAt
---------------	--------------	---------------	--------------	---------------

Calibration
constant
settingSetting the
shift
(PRESET)Setting the
roundingSetting the
projection
format

CHANEL
Setting the measuring channels

OUTPUT	L InIt	dAtA	AOUt	br IGht
---------------	---------------	-------------	-------------	----------------

Setting
the limits,
hysteresis and
delaySetting the
data outputSetting the
analog outputSetting display
brightness

OUTPUT
Setting the instrument outputs

SERv IC	ACCESS	rESEtOr	rPASS_u	IdEnt
----------------	---------------	----------------	----------------	--------------

Setting the
access rights
for „User
menu“Restoration of
manufacture
calibration
and instrument
settingChange of
the access
passwordInstrument
identification

SERv IC
Service functions

4.3.1 CONFIGURATION MODE - INPUTS

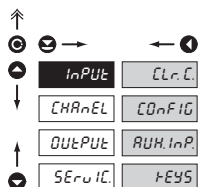

Here the basic instrument parameters are set

CLR.C Resetting the counter to zero

CONFIG Basic instrument setting

RWH.InP Setting the „Hold“ or „Lock“ functions

T.EYS Povolení nulování tlačítkem „Enter“

4.3.1.1 RESETTING THE COUNTER

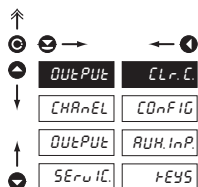

CLR.C Resetting the counter

4.3.1.2 INSTRUMENT CONFIGURATION

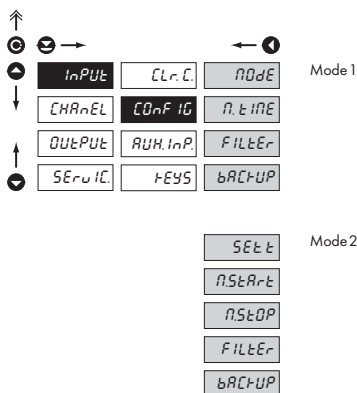

COntF IG Basic instrument setting

NOdE	Setting the instrument measuring mode
n.tIME	Setting the time base
FILtEr	Setting the input filtration constants
bRcTUP	Setting the data/time backup
SEt.t.	Time setting
nStAr.t	Setting the stopwatch control
n.StOP	Setting the stopwatch resetting

4.3.1.2.1 SETTING THE MEASURING MODE



NOdE Setting the instrument measuring mode

COUnt.	Frequency meter counter
FrEQ.u.	Frequency meter

- at the input 1 or 2

- measures frequency on Input 1 or 2

! In "Mode 2" (stopwatch/watch) this item is not visible according to the order code

4.3.1.2.2 SETTING THE MEASURING TIME/TIME BASE

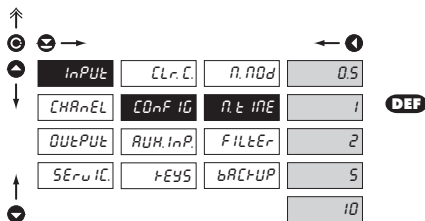

n.tIME Setting the measuring time - time base

- if you set the time of measurement for example to 1 s, the measuring time is approximately from 1 s to 2 s (1 s + maximum one period of measured signal). If no impulse comes within 2 s, it is understood that the signal has zero frequency
- range of the setting of the time base is 0,5 s to 10 s
- in the „RTC“ regime with projection of date the set time determines the period of switching between time/date, min. is 5 s, the date is displayed for approximately 2,5

4.3.1.2.3 SETTING THE INPUT FILTER PARAMETERS

INPUT	CLr.C.	NOdE	OFF
CHAnEL	COnt I0	At IAtE	200
OUtPUt	AUH.InP.	FiLTER	100
SERuIC.	tEYS	bACtUP	40
			5

DEF

FiLTER Setting the digital input filter

- through the digital filter we may suppress undesirable interfering impulses (e.g. relay back-swings) on the input signal. The set parameter indicates the maximum possible instrument frequency, which the instrument processes without restriction

When entering the contact and well known maximum input frequency we recommend using the filter

4.3.1.2.4 SETTING THE DISPLAY STATUS BACKUP

INPUT	CLr.C.	NOdE	EnAbLE
CHAnEL	COnt I0	At IAtE	dISAbL.
OUtPUt	AUH.InP.	FiLTER	
SERuIC.	tEYS	bACtUP	

DEF

bACtUP Setting the display status backup

- setting restoration of value on the display after power outage or instrument switchoff

EnAbLE After switch-on instrument reads the display status from its memory

dISAbL. After switch-on instrument becomes reset to zero

4.3.1.2.5 TIME SETTING

H

INPUT	CLr.C.	SEt t
CHAnEL	COnt I0	AtStAr-t
OUtPUt	AUH.InP.	AtStOP
SERuIC.	tEYS	FiLTER
		bACtUP

SEt t Time setting

- the time setting menu is accessible only in the stop-watch/watch regime

4.3.1.2.6 SETTING THE STOP-WATCH/WATCH CONTROL

H

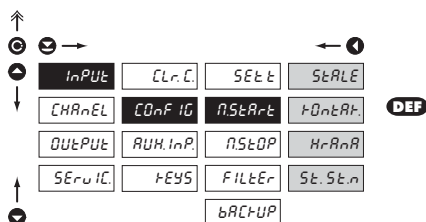

nStArE Setting the stop-watch control

StArE Stop-watch/watch is running, if the instrument is on

tOnEAr Stop-watch/watch is running at switched-on contact

HrAnR Stop-watch/watch is controlled by signal edge

St.St.n time is triggered by the edge (passage of the signal across the comparator level) and stopped by the next edge

St.St.n Stop-watch/watch is controlled and reset to zero by signal edge

St.St.n the time is triggered by the edge (passage of the signal across the comparator level) and stopped and reset to zero by the next edge

4.3.1.2.7 SETTING THE STOP-WATCH/WATCH CONTROL - RESETTING

H

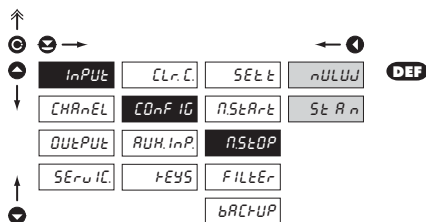

nStOP Setting the stop-watch resetting to zero

nULUJ Stop-watch/watch is reset to zero by input „Zeroizing“

StAn Stop-watch/watch is stopped and reset to zero by input „Zeroizing“

4.3.1.2.8 SETTING THE DISPLAY STATUS BACKUP

H

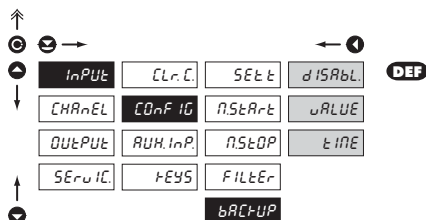

bRctUP Setting the display status backup

setting restoration of value on the display after power outage or instrument switchoff

dISAbL After switch-on instrument becomes reset to zero

uRLUE After switch-on instrument reads the display status from its memory

tInE Instrument reads „running“ time from RTC

4.3.1.3 SETTING THE AUXILIARY INPUT

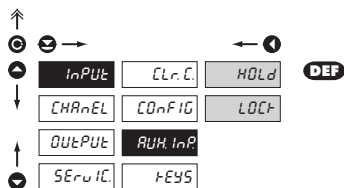
AUX.InP Setting the auxiliary input

HOLD The auxiliary input controls the „HOLD“ function

- the input controls the HOLD function , stop measuring/instrument switchoff

LOCK Auxiliary input controls the „LOCK“ function

- the input controls the blocking of the keys on the front panel

4.3.1.4 PERMISSION TO RESET BY THE ENTER KEY

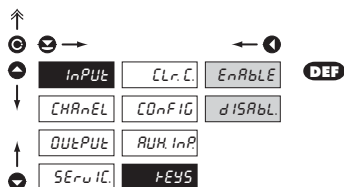
KEYS Permission to reset by the „ENTER“ key

EnABLE Resetting to zero by the ENTER key is permitted

DISABL Resetting to zero by the ENTER key is prohibited

4.3.2 CONFIGURATION MODE - CHANNELS

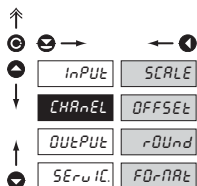

Here the basic parameters of the instrument input values are set

SCALE	Calibration constant
n.P.S.	Additive constant PRESET
rQUnd	Setting the data rounding
FDRARt	Setting the projection format

4.3.2.1 SETTING THE CALIBRATION CONSTANT

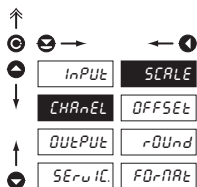

SCALE Setting the calibration constant

- calibration constant is for the conversion of input value to required display value
- by setting a minus value the direction of counting is changed, i.e. we count down
- range: -0,00001...999999

- DEF = 1

4.3.2.2 OFFSET SETTING

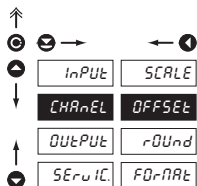

OFFSEt Setting the additive constant „PRESET“

- shift of the beginning of the measurement by a set value which will always be read upon instrument resetting
- range: -99999...99999

- DEF = 0

4.3.2.3 MEASURED VALUE ROUNDING

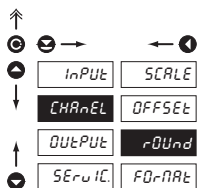

rOUnd Measured value rounding

- it is set by an optional number which determines the projection step (e.g. step 2,5 - 0, 2,5, 5, 7,5, etc.)

4.3.2.4 PROJECTION FORMAT

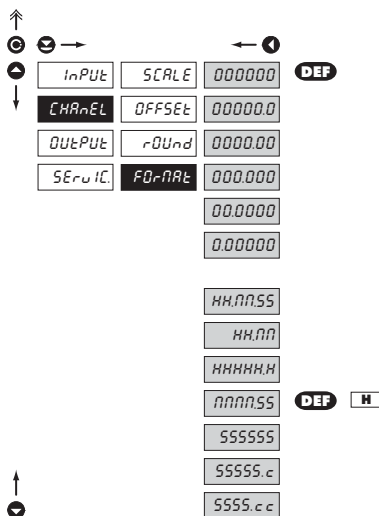

FORMAT Setting the projection format

- the instrument enables projection of a number with decimal positioning of the decimal point
- for projection of time there are also other forms of projection

4.3.3 CONFIGURATION MODE - OUTPUT

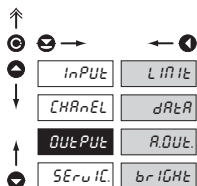

LIMIt Setting the functions and type of limits switch-on

dRAr Setting the type and parameters of data output

R.OuT Setting the type and parameters of analog output

brIGHt Setting the display brightness

4.3.3.1.1 LIMITS - SETTING THE RELAY MODE

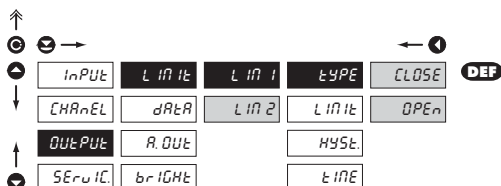

tYPE Setting the relay switching mode

CLOSE The relay switches on when the condition is met

OPEn The relay switches off when the condition is met

4.3.3.1.2 LIMITS - SETTING THE BOUNDARIES

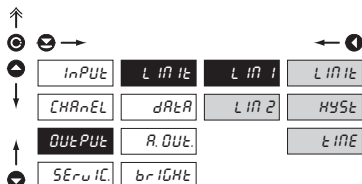

LIMI - Setting the values for limits evaluation

LIMI2 Setting limit for relay switch on

- in full display range

HYSI Setting hysteresis only in (+) values

- in 1/10 of the display range

tINE Setting the delay of the limit switch-on

- in range 0...99,9 s

4.3.3.2.1 DATA OUTPUT - SETTING THE TRANSMISSION RATE

Navigation icons: Up, Home, Left, Right, Down, Up, Down.

INPUt	LIInIt	bRUD	1200
CHAnEL	dRtR	Addr.	2400
OUtPUt	R.OUt.		4800
SERvIC.	brIGHt		9600
			19200
			38400

DEF

bRUD Setting the rate of data output (baud)

1200	Rate - 1 200 Baud
2400	Rate - 2 400 Baud
4800	Rate - 4 800 Baud
9600	Rate - 9 600 Baud
19200	Rate - 19 200 Baud
38400	Rate - 38 400 Baud

4.3.3.2.2 DATA OUTPUT - SETTING THE INSTRUMENT ADDRESS

Navigation icons: Up, Home, Left, Right, Down, Up, Down.

INPUt	LIInIt	bRUD
CHAnEL	dRtR	Addr.
OUtPUt	R.OUt.	
SERvIC.	brIGHt	

DEF

Addr Setting the instrument address

- setting in the range of 0...31
- manufacture setting 00 **DEF**

4.3.3.3.1 ANALOG OUTPUT - SETTING THE TYPE

Navigation icons: Up, Home, Left, Right, Down, Up, Down.

INPUt	LIInIt	tYPE	0-20mA
CHAnEL	dRtR	nIn	4-20mA
OUtPUt	R.OUt.	RRH	0-5mA
SERvIC.	brIGHt		0-2V
			0-5V
			0-10V

DEF

tYPE Setting the type of analog output

- current and voltage outputs are galvanically separated

0-20mA	Output: 0...20 mA
4-20mA	Output: 4...20 mA
0-5mA	Output: 0...5 mA
0-2V	Output: 0...2 V
0-5V	Output: 0...5 V
0-10V	Output: 0...10 V

4.3.3.3.2 ANALOG OUTPUT - SETTING THE RANGE

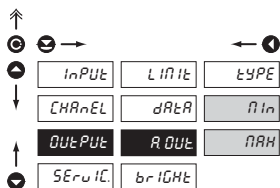
R. OUT. Setting the range of the analog output

- analog output is isolated and its value corresponds with the displayed data. It is fully programmable, i.e. it enables to assign the AO limit points to two arbitrary points from the entire measuring range

AIN Assigning the display value to the beginning of the range of the analog output

- range of the setting is .99 999...999 999

RAH Assigning the display value to the end of the range of the analog output

- range of the setting is .99 999...999 999

4.3.3.3.3 SETTING THE DISPLAY BRIGHTNESS

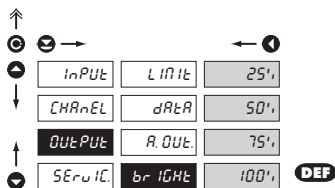
br IGHt Setting the display brightness

25% Brightness 25%

50% Brightness 50%

75% Brightness 75%

100% Brightness 100%

4.3.4 CONFIGURATION MODE - SERVICE

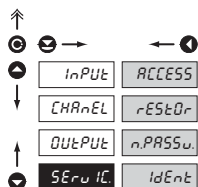

ACCESS	Setting the access rights for „User mode“
RESETDR	Return to manufacture calibration or setting
NPASSW	Change of the access password
IDENT	Instrument identification

4.3.4.1 SETTING THE ACCESS RIGHTS FOR „USER MODE“ - LIMITS



LIMIT - Nastavení přístupových práv do Limit v „UM“

LIMIT	Authorization for item „LIMIT“, setting the limit
HYST	Authorization for item „HYST.“, setting hysteresis
TIME	Authorization for item „TIME.“, setting the switch-on delay

In all items the following parameters may be selected

DISABL	The item is not projected in the „UM“
SHDW	The item is projected in the „UM“ but cannot be changed
EDIT	The item has full access in the „UM“ including

4.3.4.2 RETURN TO MANUFACTURE CALIBRATION/SETTING

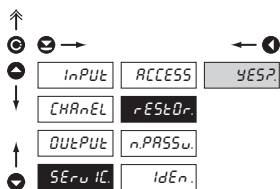

rEStOr. Return to manufacture calibration and instrument setting

- in case of incorrect setting or calibration it is possible to return to manufacture setting. Prior execution of the changes you will be asked to confirm your choice „Yes?“

4.3.4.3 SETTING NEW ACCESS PASSWORD

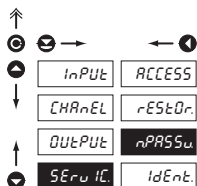

nPASSu Setting new access password for „Configuration menu“

- this selection allows to change the numeric code which blocks the access into the „Configuration mode“ of the instrument. Range of the numeric code is 0...9999

4.3.4.4 INSTRUMENT IDENTIFICATION

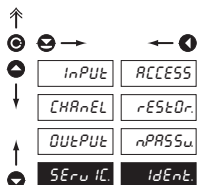

IdEnt Projection of the instrument version

- the display shows the type identification of the instrument with the inspection number
- name of the instrument - measuring mode - version SW + hour SW - date (DD/MM/YY)

5. DATA PROTOCOL

The instruments communicate via serial line RS232 or RS485. For communication they use the ASCII protocol. The communication is running in the following format:

ASCII: 8 bit, no parity, one stop bit











Transmission rate is adjustable in the instrument menu and depends on the used control processor. The instrument address is set in the instrument menu in the range of 0...31. Manufacture setting always presets the ASCII protocol, rate of 9600 Baud, address 00. Type of line used - RS232 / RS485 - is determined by exchangeable card automatically identified by the instrument.

COMMANDS FOR INSTRUMENT OPERATION

The commands are described in the description which can be found at www.orbit.merret.cz/rs.

A command consists of a couple number-letter, where the letter size is of importance.

COMMANDS NOT LISTED IN THE MENU

1M	 	Send minimum value
2M	 	Send maximum value
1X	 	Send display value, data format „R <SP> DDDDDDDD“
1Z	 	Send HW instrument configuration
1x	 	Send output value from filter of Channel A

6. ERROR STATEMENTS

ERROR	REASON	ELIMINATION
<i>Er.Und.</i>	range underflow	change the input signal value or change display projection
<i>Er.Über.</i>	range overflow	change the input signal value or change display projection
<i>ErrOr</i>	incorrect access password into Configuration mode	repeat the command with correct password
<i>Er.EMEN</i>	violation of data integrity in EEPROM, error upon data storage	in case of recurring report send the instrument for repair
<i>Er.MEM</i>	EEPROM error	the „Def“ values will be used in emergency, instrument needs to be sent for repair

7. TECHNICAL DATA

INPUT

Type:	upon contact, TTL, NPN/PNP
Measurements:	1x counter/freq./repeat/phase UP or DOWN 2x counter/frequency UP nebo DOWN 1x counter/frequency UP/DOWN 1x counter/frequency UP/DOWN pro IRC 1x stop-watch/watch - measuring range is adjustable

Input frequency: 0,1...50 kHz

PROJECTION

Display:	999999, intensive red or green 14-segment LED, digit height 14 mm
Projection:	-99999...999999
Decimal point:	adjustable - in programming mode
Brightness:	adjustable - in programming mode

INSTRUMENT ACCURACY

Temp.coefficient:	50 ppm/°C
Accuracy:	±0,05 % of range (frequency)
Time base:	0,5/1/5/10 s
Calibrat.coefficient:	±0,00001...99999
Filtration constant:	allows to set maximum valid frequency, which is processed (OFF/5...200 Hz)
Type of filter:	sampling
Pre-setting:	-99999...999999
Functions:	data backup - storing measured data even after the instrument switches off (EEPROM) Hold - stop measuring (upon contact) Locking the keyboard (upon contact)
Watch-dog:	reset after 20 ms
Calibration:	at 25°C and 40 % r.h.

COMPARATOR

Type:	digital, adjustable in menu contact switch-on < 50 ms
Limits:	-99999...99999
Hysteresis:	0...99999
Delay:	0...99,9 s
Outputs:	2x relays with switching contact (230 VAC/30 VDC, 3 A)*
Relays:	1/8 HP 277 VAC, 1/10 HP 125 V, Pilot Duty D300

DATA OUTPUTS

Protocols:	ASCII
Data format:	8 bit + no parity + 1 stop bit
Rate:	1 200...38 400 Baud
RS 232:	isolated, two-way communication
RS 485:	isolated, two-way communication, addressing (max. 31 instruments)

ANALOG OUTPUTS

Type:	isolated, programmable with resolution of max. 10 000 points, analog output corresponds with the displayed data, type and range are adjustable
Non-linearity:	0,2 % of the range
TC:	100 ppm/°C
Rate:	response to change of value < 100 ms
Voltage:	0...2 V/5 V/10 V
Current:	0...5/20 mA/4...20 mA - compensation of conduct up to 600 Ohm

EXCITATION

Fixed: 15 VDC/25 mA, isolated

POWER SUPPLY

Options:	24/110/230 VAC, 50/60 Hz, ±10 %, 3 VA 10...30 VDC/max. 250 mA (24 VDC/90 mA),
Protection:	melting fuse inside the instrument VAC (T 80 mA), VDC (T 630 mA)

MECHANIC PROPERTIES

Material:	Noryl GFN2 SE1, nehořlavý UL 94 V-I
Dimensions:	96 x 48 x 120 mm
Panel cut-out:	90,5 x 45 mm

OPERATING CONDITIONS

Connection:	connector terminal board, conductor cross section up to 2,5 mm ²
Stabilisation period:	within 15 minutes after switch-on
Working temp.:	0°...60°C
Storage temp.:	-10°...85°C
Cover:	IP65 (front panel only)
Construction:	safety class I
Overvoltage categ.:	CSN EN 61010-1, A2 III. - instrument power supply (300 V) II. - input, output, excitation (300 V) for pollution degree II
EMC:	EN 61000-3-2+A12; EN 61000-4-2, 3, 4, 5, 8, 11; EN 550222, A1, A2

* values apply for resistance load

8. INSTRUMENT DIMENSIONS AND INSTAL.

Front view

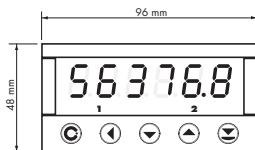

Panel cut

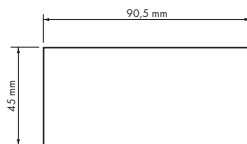

Side view

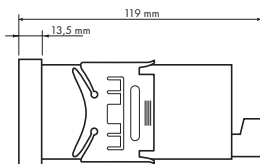

Panel thickness: 0,5...20 mm

Instrument installation

1. insert the instrument into the panel cut-out
2. fit both travellers on the box
3. press the travellers close to the panel

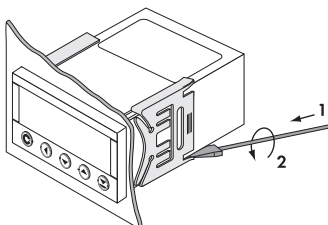
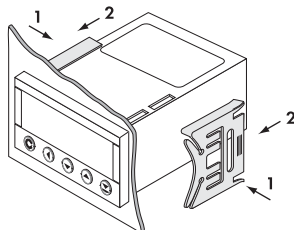

Instrument disassembly

1. slide a screw driver under the traveller wing
2. turn the screw driver and remove the traveller
3. take the instrument out of the panel

9. CERTIFICATE OF GUARANTEE

Product **OM 651UC**
 Type
 Manufacturing No
 Date of sale

A guarantee period of 24 months from the date of sale to the user applies to this instrument.

Defects occurring during this period due to manufacture error or due to material faults shall be eliminated free of charge.

For instrument quality, function and construction the guarantee shall apply provided that the instrument was connected and used in compliance with the instruction for use.

The guarantee shall not apply for defects caused by:

- mechanic damage
- in transport
- intervention of unqualified person incl. the user
- unavoidable event
- other unprofessional interventions

The manufacturer performs the guarantee and post-guarantee repairs unless provided for otherwise.

Stamp, signature

DECLARATION OF CONFORMITY

Assessment of conformity pursuant to Section 12, par. 4 b, d of Act No. 22/1997 Sb..

Company: **ORBIT MERRET, spol. s r.o.**
Klánova 81/141, 142 00 Prague 4, Czech Republic, IČO: 00551309

Manufacturer: **ORBIT MERRET, spol. s r.o.**
Vodňánská 675/30, 198 00 Prague 9, Czech Republic

prohlašuje na svou výlučnou odpovědnost, že níže uvedený výrobek splňuje požadavky technických předpisů, že výrobek je za podmínek námi určeného použití bezpečný a že jsme přijali veškerá opatření, kterými zabezpečujeme shodu všech výrobků níže uvedeného typu, uváděných na trh, s technickou dokumentací a s požadavky příslušného nařízení vlády.

Product: 6 digit measuring instruments

Type: **OM 651**

Version: UC

Conformity is assessed pursuant to the following standards:

Electr. safety:	EN 61010-1
EMC:	EN 50131-1, chapt. 14 and chapt. 15
	EN 50130-4, chapt. 7
	EN 50130-4, chapt. 8
	EN 50130-4, chapt. 9
	EN 50130-4, chapt. 10
	EN 50130-4, chapt. 11
	EN 50130-4, chapt. 12
	EN 50130-4, chapt. 13
	EN 50130-5, chapt. 20
	prEN 50131-2-1, article 9.3.1
	EN 61000-4-8
	EN 61000-4-9
	EN 61000-3-2 ed. 2:2001
	EN 61000-3-3: 1997, Cor. 1:1998, Z1:2002
	EN 55022, chapt. 5 and chapt. 6.
	EN 61000-4-11
	EN 61000-4-2
	EN 61000-4-3
	EN 61000-4-6
	EN 61000-4-4
	EN 61000-4-5

As evidence serve the protocols of authorised and accredited organisations:

VTÚE Praha, examination laborator No. 1158, accredited by ČIA
VTÚPV Vyškov, examination laborator No. 1103, accredited by ČIA

Prague, 18. 12. 2003

Miroslav Hackl v.r.
General manager