

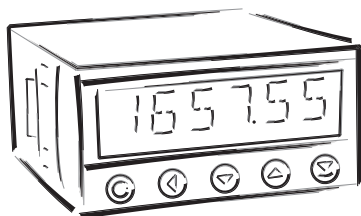

OM 653UQC

6 DIGIT PROGRAMMABLE

IMPULSE COUNTER
FREQUENCY METER
STOPWATCH/TIMER





SAFETY INSTRUCTIONS

Please, read the enclosed safety instructions carefully and observe them!
These instruments should be safeguarded by isolated or common fuses (breakers)
For safety information the EN 61 010-1 + A2 standard must be observed.
This instrument is not explosion-safe!

TECHNICAL DATA

Measuring instruments of the DM 653 series conform to the European regulation 89/336/EWG.

The instruments are up to the following European standards:
EN 61010-1, Electric safety
EN 61326-1, Electronic measuring, control and laboratory devices – Requirements for EMC "Industrial use"

The instruments are applicable for unlimited use in agricultural and industrial areas.

CONNECTION

Supply of energy from the main line has to be isolated from the measuring leads.

ORBIT MERRET, spol. s r.o.

Vodňanská 675/30
198 00 Prague 9
Czech Republic

Tel: +420 - 281 040 200
Fax: +420 - 281 040 299
e-mail: orbit@merret.cz
www.orbit.merret.cz



1. CONTENS	3	6.2 "PROFI" menu - CHANNELS	
2. INSTRUMENT DESCRIPTION	4	6.2.1 Setting calibration constants and offset.	48
3. INSTRUMENT CONNECTION.	6	6.2.2 Setting digital filter	49
Measuring ranges	6	6.2.3 Projection format	50
Instrument connection.	6	6.3 "PROFI" menu - OUTPUTS	
Recommended connection of sensors.	7	6.3.1 Configuration and setting the limits.	52
Termination of RS 485 communication line.	8	6.3.2 Setting data output	55
Table of comparison levels	8	6.3.3 Setting analog output	56
4. INSTRUMENT SETTING	10	6.3.4 Setting display brightness	57
Symbols used in the instructions	12	6.4 "PROFI" menu - SERVICE	
Setting the DP and the (-) sing	12	6.4.1 Selection of the type of programming menu „LIGHT"/„PROFI"	60
Control keys functions	13	6.4.2 Restoration of manufacture setting.	61
Configuration of „User" menu items	13	6.4.3 Setting new access password	61
5. SETTING "LIGHT" MENU	14	6.4.4 Instrument identification	61
5.0 Description "LIGHT" menu	15	7. SETTING "USER" MENU	62
Access to menu	16	8. DATA PROTOCOL	64
Setting initial value	16	9. ERROR STATEMENTS	66
Selection of instrument measuring mode	17	10. TECHNICAL DATA	68
Selection of digital input filter.	17	11. INSTRUMENT DIMENSION AND INSTALLATION	70
Selection of control START „START"	18	12. CERTIFICATE OF GUARANTEE	71
Selection of control START „STOP"	18		
Automatic setting of the inputs	19		
Setting multiplying constant, offset and projection format - channel Counter.	20		
Setting multiplying constant, offset and projection format - channel Frequency.	22		
Setting limits.	24		
Setting analog output	26		
Setting display projection.	28		
Setting the menu type (LIGHT/PROFI)	28		
Restoration of manufacture setting	29		
Setting new access password	30		
Instrument identification.	30		
6. SETTING "PROFI" MENU	32		
6.0 Description "PROFI" menu.	32		
6.1 "PROFI" menu - INPUT			
6.1.1 Resetting internal values	34		
6.1.2 Instrument configuration.	35		
6.1.3 Setting external control input	45		
6.1.4 Setting function of the control key	46		

2. INSTRUMENT DESCRIPTION



2.1 DESCRIPTION

The OM 653UQC model is a universal 6 digit panel programmable impulse counter/frequencymeter and stopwatch/timer. The instrument is based on an 8-bit microprocessor, which secures high accuracy, stability and easy operation of the instrument.

MEASURING MODES

SINGLE	Counter/Frequencymeter	C / F
QVADR	Counter/Frequencymeter for IRC sensors	C / F
UP/DW	UP/DW Counter/Frequencymeter - used in inputs A, C (direction) and can display count/frequency	C / F
UP - DW	UP - DW Counter/Frequencymeter - used in inputs A (UP), C (DW) and can display count/frequency	C / F
TIME	Stopwatch	H
RTC	Timer	H

PROGRAMMABLE PROJECTION

Calibration	in „CM“ (calibration mode) a multiplication and division constant can be set (division constant in the range of integer numbers from 2 to 100 will enable accurate measurements relative to the set value, or its multiplication)
Projection	-99999...999999 with fixed or floating DP, for measuring modes STOPWATCH/TIMER with the option of setting in format 10/24/60
Measuring channels	two independent functions may be evaluated from each input (Counter/Frequency)
Time base	0,5 s/1 s/2 s/5 s/10 s

LINEARIZATION

Linearization	by linear interpolation in 25 points (solely via OM Link) - a single table for frequency, alternatively for counting pulses when frequency not used
---------------	--

DIGITAL FILTERS

Input filter	the instrument enables filtering the input signal and thus suppress unwanted interfering signals (e.g. relay backswings). The parameter set gives maximum feasible measured frequency processed by the instrument, 5/40/100/1 000 Hz
Exponen.average	from 2...100 measurements
Rounding	setting projection step for display
1/Fr.	a filter which converts frequency to time

FUCTIONS

Setting the value	entering the current count when installing the counter during a counting cycle
Preset	initial non-zero value, unloaded always after instrument resetting
Summation	used for cummulative summations of values (for example shifts in a factory), where the value on the display is added to the total value (grand total) when the display is zeroed at the beginning of each shift
Tare	used for zeroing the display when the input frequency is not zero

EXTERNAL CONTROL

Hold	display/instrument blocking
Lock	locking the control keys for access into Configuration menu
Resettting	resetting/pre-setting the counter
Tare	tare activation
Start/Stop	stopwatch/timer control
Select	selecting the channel to be projected

2.2 OPERATION

The instrument is set and controlled by five control keys located on the front panel. All programmable settings of the instrument are realized in two adjusting modes:

LIGHT	Simple programming menu - contains only items necessary for instrument setting and is protected by an optional numeral code
PROFI	Complete programming menu - contains complete instrument menu and is protected by an optional numeral code
USER	User programmable menu - may contain arbitrary items selected from programmable menu (LIGHT/PROFI), which determines the authorization (see or change) - access is without password

All programmable parameters are stored in the EEPROM memory (they hold even after the instrument is switched off).

OMLINK Complete operation and setting of the instrument may be performed via communication interface OM Link, which is a standard equipment of every instrument.

The operation program is freely available (www.orbit.merret.cz) and the only requirement is the purchase of OML cable for connecting the instrument to PC. It is manufactured in version RS 232 and USB and is compatible with all ORBIT MERRET instruments. Another option for connection is with the aid of data output RS 232 or RS 485 (without the need for OML cable).

The OM LINK program version „Standard“ allows you to connect an unlimited number of instruments with the option of visualization and storage in PC.

2.3 EXTENSION

Extension is suitable for feeding sensors and converters. It has a galvanic isolation.

Comparators are assigned to control two limit values with relay output. The modes: „Hysteresis“/„Zero and pulse“/„Once“ can be assigned by user to the first relay and for the second relay it is starting the stopwatch/clock. The limits have adjustable hysteresis as well as selectable delay of the switch-on. Reaching the preset limits is signalled by LED and simultaneously by the switch-on of the relevant relay.

Data output are for their rate and accuracy suitable for transmission of measured data for further projection or directly into the control systems. We offer an isolated RS232 and RS485 with the ASCII protocol.

Analog output will find their place in applications where further evaluating or processing of measured data in external devices is required. We offer a universal analog output with the option of selection of output type - voltage/current. The value of analog output corresponds with the displayed data and its type and range are selectable in the programming mode.

Time backup by means of RTC circuit is designed for the „TIMER“ measuring mode and secures time measuring even if the instrument is switched-off (without display projection).

3. INSTRUMENT CONNECTION

The instrument supply leads should not be in proximity of the incoming low-potential signals.

Contactors, motors with larger input power should not be in proximity of the instrument.

The leads into the instrument input (measured quantity) should be in sufficient distance from all power leads and appliances. Provided this cannot be secured it is necessary to use shielded leads with connection to ground (bracket E).

The instruments are tested in compliance with standards for use in industrial area, yet we recommend to abide by the above mentioned principles.

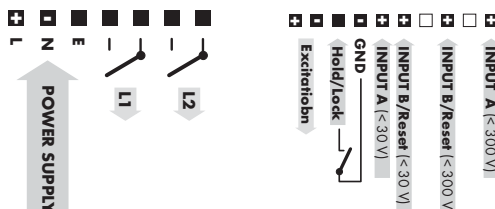
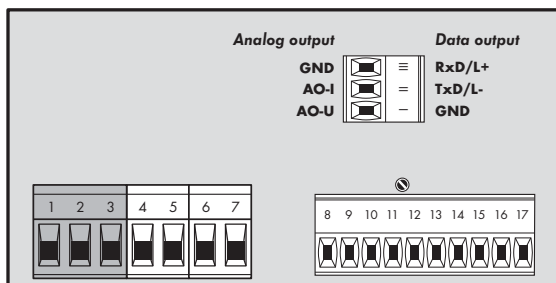

!
Grounding on bracket „E“ has to be connected at all times

CONNECTION

	DESCRIPTION	CONNECTION
INPUT A (< 30 V)	input signal < 43 V	GND + Input A [< 30 V]
INPUT A (< 300 V)	input signal < 300 V	GND + Input A [< 300 V]
INPUT B/Reset (< 30 V)	input signal < 43 V	GND + Reset [< 30 V]
INPUT B/Reset (< 300 V)	input signal < 300 V	GND + Reset [< 300 V]

EXTERNAL INPUT

	DESCRIPTION	CONTROL
EXT.	According to setting in Menu [see Menu > EXT. IN., page 45]	upon contact, bracket [No. 10/11]

FUNCTIONS OF INPUTS ACCORDING TO SELECTED MODE

MODE	DESCRIPTION	FUNCTION OF INPUTS
SINGLE	Pulse counter/Frequency counter	Input A, Resetting (Input B)
QUADR.	Pulse counter/ Frequency counter for IRC sensors	Input A + Input B, Resetting is possible on terminal 10
UP/DW	UP or DW Pulse counter/Frequency counter	Input A, Input B - determines direction [Hi = UP, Lo = DW] Resetting is possible on terminal 10
UP - DW	UP/DW Pulse counter/Frequency counter	Input A (UP), Input B (DW), Resetting is possible on terminal 10
TIME	Stopwatch Clock	Input A, Resetting (Input B)
RTC	Stopwatch Clock with time back up	Input A, Resetting (Input B)

Sensor connection

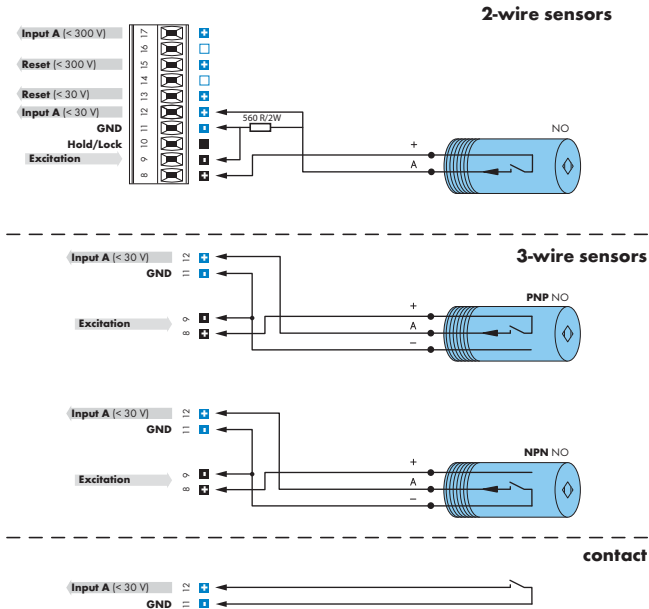

Sensors with PNP or NPN output have always only one „fixed“ level and therefore it is extremely important the leads are properly shielded and separated from possible sources of interference. If interference occurs, it can be included in the measurement. One of the ways of eliminating this possible problem is applying an input signal filter in the Menu.

3. INSTRUMENT CONNECTION

Termination of RS 485 communication line

X3 - Termination of communication line RS 485

Full	Significance	Default	Recommendation
1-2	connect L+ to (+) source	terminalconnected	connect at the end of line do not disconnect
3-4	termination of line 120 Ohm	disconnected	
5-6	connect L- to (-) source	terminalconnected	

RS 485 line should have a linear structure - wires (ideally shielded and twisted) should lead from one device to another.

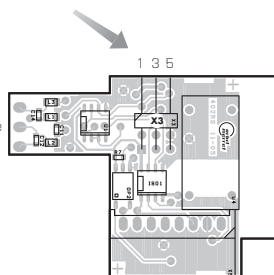

Comparator levels

Setting comparator levels for individual inputs is realised in the „LIGHT“ or in the „PROFI“ menu.

When setting the level manually by front panel buttons please set the required value first, then confirm by pressing the „ENTER“ button. The value you have selected is automatically adjusted to the corresponding comparator level (see the table below).

TABLE OF COMPARISON LEVELS [V]

INPUT	TYPE OF INPUT	MAXIMUM INPUT VOLTAGE (LEVEL A, C)	MAXIMUM COMPARISON LEVELS	
			L > H	H > L
Input A Resetting (< 30 V)	NPN, Kontakt	xxx	0,5 V	4,5 V
	PNP	9,7 V	0,5 V	4,5 V
	PNP	14,4 V	1,0 V	9,0 V
	PNP	19,2 V	1,5 V	13,3 V
	PNP	23,9 V	2,0 V	17,8 V
	PNP	28,7 V	2,5 V	22,1 V
	PNP	33,5 V	3,0 V	26,6 V
	PNP	38,3 V	3,4 V	31,0 V
Input A Resetting (< 300 V)	PNP	43,0 V	3,9 V	35,5 V
	NPN, Contact		!!! prohibited !!!	
	PNP	84 V	4,9 V	39,8 V
	PNP	128 V	9,2 V	78,0 V
	PNP	170 V	13,6 V	117,8 V
	PNP	211 V	17,8 V	156,0 V
	PNP	253 V	22,3 V	195,8 V
	PNP	295 V	26,5 V	234,1 V
PNP	301 V	30,9 V	273,9 V	





SETTING **PROFI**

For expert users

Complete instrument menu

Access is password protected

Possibility to arrange items of the **USER MENU**

Tree menu structure

SETTING **LIGHT**

For trained users

Only items necessary for instrument setting

Access is password protected

Possibility to arrange items of the **USER MENU**

Linear menu structure

SETTING **USER**

For user operation

Menu items are set by the user (Profi/Light) as per request

Access is not password protected

Optional menu structure either tree (PROFI) or linear (LIGHT)

4.1 SETTING

The instrument is set and controlled by five control keys located on the front panel. All programmable settings of the instrument are realized in two adjusting modes:

- LIGHT** **Simple programming menu**
 - contains only items necessary for instrument setting and is protected by an optional numeral code
- PROFI** **Complete programming menu**
 - contains complete instrument menu and is protected by an optional numeral code
- USER** **User programmable menu**
 - may contain arbitrary items selected from programmable menu (LIGHT/PROFI), which determines the authorization (see or change)
 - access is without password

All programmable parameters are stored in the EEPROM memory (they hold even after the instrument is switched off).

Complete operation and setting of the instrument may be performed via communication interface OM Link, which is a standard equipment of every instrument.

The operation program is freely available (www.orbit.merret.cz) and the only requirement is the purchase of OML cable for connecting the instrument to PC. It is manufactured in version RS 232 and USB and is compatible with all ORBIT MERRET instruments. Another option for connection is with the aid of data output RS 232 or RS 485 (without the need for OML cable).

Scheme of processing the measured signal

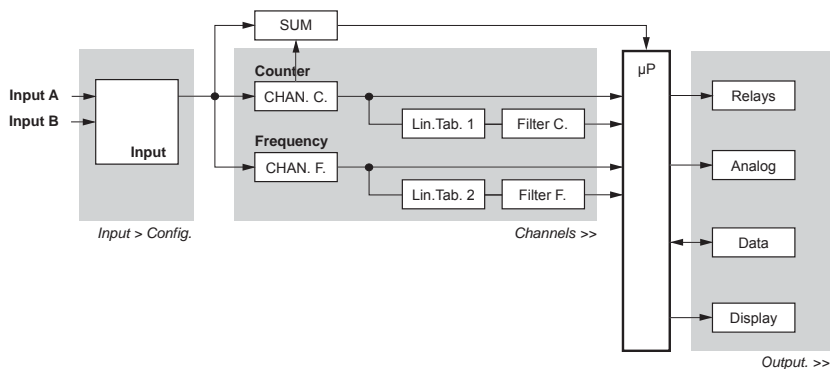

4. INSTRUMENT SETTING

Setting and controlling the instrument is performed by means of 5 control keys located on the front panel. With the aid of these keys it is possible to browse through the operation menu and to select and set required values.

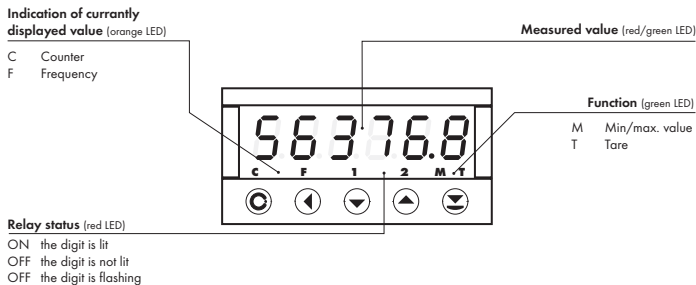

Symbols used in the instructions

- C F H Q** Indicates the setting for given type of instrument
- DEF** values preset from manufacture
- symbol indicates a flashing light (symbol)
- MIN** inverted triangle indicates the item that can be placed in USER menu
- CONNECT** broken line indicates a dynamic item, i.e. it is displayed only in particular selection/version
- after pressing the key the set value will not be stored
- after pressing the key the set value will be stored
- 30** continues on page 30

Setting the decimal point and the minus sign

DECIMAL POINT

Its selection in the menu, upon modification of the number to be adjusted it is performed by the control key with transition beyond the highest decade, when the decimal point starts flashing. Positioning is performed by .

THE MINUS SIGN

Setting the minus sign is performed by the key on higher decade. When editing the item subtraction must be made from the current number (e.g.: 013 > , on class 100 > -87)

Control keys functions

KEY	MEASUREMENT	MENU	SETTING NUMBER/SELECTION
	access into USER menu	exit menu w/o saving	transition to next item w/o saving
	programmable key function	return to previous level	move to higher decade
	programmable key function	move to previous item	move down
	programmable key function	move to next item	move up
	programmable key function	confirm selection	setting/selection confirmation
			numeric value is set to zero
	access into LIGHT/PROFI menu		
	direct access into PROFI menu temporary (remains LIGHT)		
		configuration of an item for "USER" menu	
		determine the sequence of items in "USER - LIGHT" menu	

Setting items into „USER“ menu

- in **LIGHT** or **PROFI** menu
- no items permitted in **USER** menu from manufacture
- on items marked by inverted triangle

USER

legend is flashing - current setting is displayed



NO

item will not be displayed in USER menu

YES

item will be displayed in USER menu with the option of setting

SHOW

item will be solely displayed in USER menu



SETTING LIGHT

For trained users

Only items necessary for instrument setting

Access is password protected

Possibility to arrange items of the **USER MENU**

Linear menu structure

Access password

1428 + PASS 0

Initial value SET.U 0 Measuring mode MODE SINGLE Input filter FILTER OFF

Mode - input MSTART CONTACT Mode - reset MSTOP CLEAR
ONLY FOR MODE > TIME AND RTC

Type of inputs SET.N YES Input A A= NPN Input B B= NPN

Setting calibration constant - counter SCAL.C 1 DI.V.C 1 OFFS.C 0 FORM.C 000000

Setting calibration constant - frequency SCAL.F 1 DI.V.F 1 OFFS.F 0 FORM.F 00000.0

I.M.P.L1 COUNT U.M.L1 25 I.M.P.L2 COUNT U.M.L2 75
Option - Comparator

I.M.P.A.O. COUNT TYP.A.O. I 20 MIN.A.O. 0 MAX.A.O. 100
Option - Analog output

Selection of the channel to be displayed I.M.P.D. COUNT Menu type MENU LIGHT Return to manufacture setting F.R.M. YES Return to user setting USER YES

New password PAS.U 0 Identification IDENT. YES Type of instrument OM 653UOC version SW 64-001 mode SINGLE 1428 **Return to previous measuring mode**

Preset from manufacture

Password "0"
Menu LIGHT
USER menu vypnuté
Setting the items **DEF**



Upon delay exceeding 60 s the programming mode is automatically discontinued and the instrument itself restores the measuring mode

5. SETTING LIGHT

1428



PASS.

0

Entering access password
for access into the menu

PASS. Access into instrument menu

PASS. = 0

- access into menu is unrestricted, after releasing keys you automatically move to first item of the menu
- **PASS. > 0**
- access into menu is protected by numeric code

Set "PASS" = 42 Example

0	1	2	02	12	22
32	42	TYP			

SET V.

0

Setting initial value

SET V. Setting initial value

- the function allows the user a single-time setting of initial value of display projection
- the instrument is preset from manufacture into "FREQU." measuring mode and unless another mode is set the item remains hidden
- if you need to set initial value for another mode it is necessary to do so upon next access to programming menu > after change of measuring mode
- setting "SET V." is a one-time operation unlike the "OFFSET" option, i.e. after resetting the display value is "0", provided there is no other value set in the "OFFSET" item

DEF = 0

Set "SET V." = 233 Example

0	1	2	3	03	13
23	33	033	133	233	MODE

!

The item „SET V.“ is not projected for measuring mode „FREQU.“



MODE Selection of instrument measuring mode

- elementary selection of instrument type

DEP = SINGLE

MODE	Menu	Measuring mode
	SINGLE	Counter/Frequencymeter
	QUADR.	Counter/Frequencymeter for IRC
	UP/DW	UP/DW - Counter/Frequencymeter
	UP-DW	UP/DW - Counter/Frequencymeter
	TIME	Stopwatch/timer
	RTC	Stopwatch/backup timer

- detail description of measuring modes is on page 7 and 40

Selection of - RTC > RTC Example

SINGLE RTC FILTER

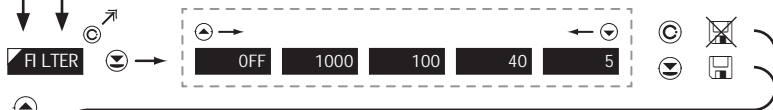

FILTER Selection of digital filter

- digital filter may suppress unwanted interfering impulses (e.g. relay backswings) on the input signal. The set parameter gives maximum possible frequency, which the instrument processes w/o limitation
- for pulse duty cycle of 50 % - equal duration of Hi and Lo level!

DEP = OFF

In this setting the instrument will only register signal of max 100 Hz, higher frequency will be discarded Example

Filter > 100

OFF 1000 100 MSTART



When accessing upon contact and available maximum input frequency we recommend using filter

5. SETTING LIGHT

MEASURING MODE > "TIME" and "RTC"

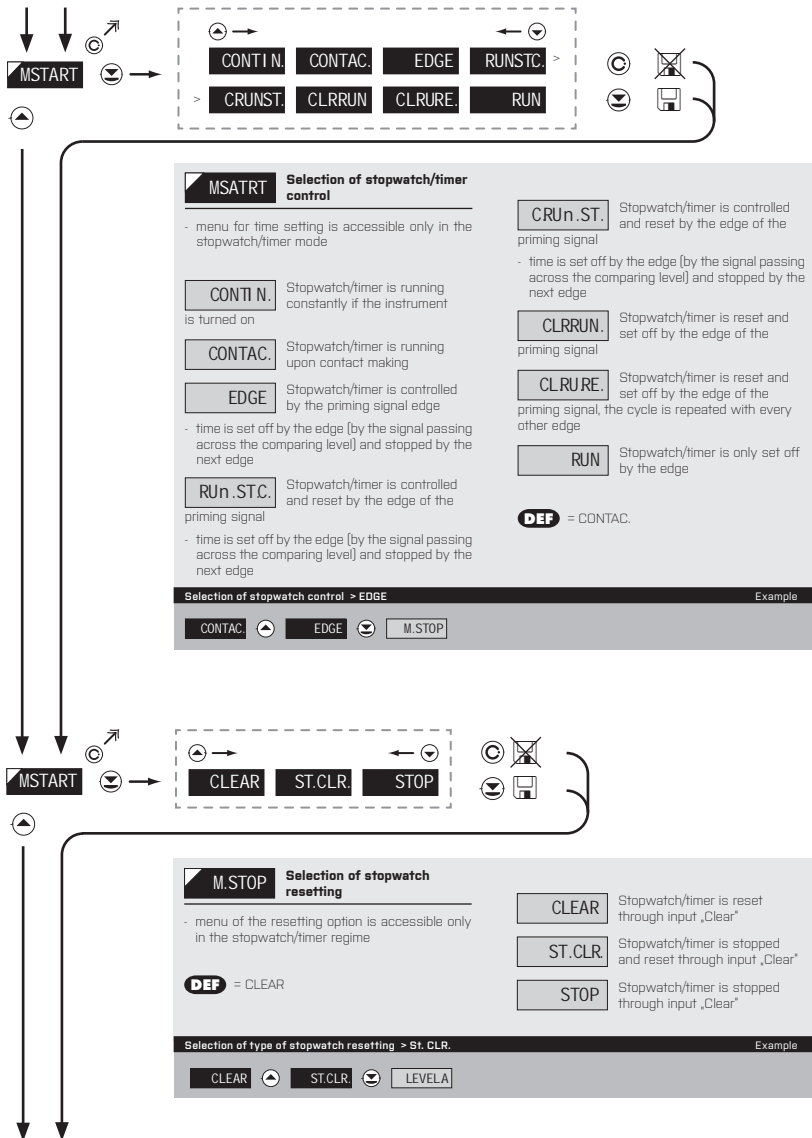

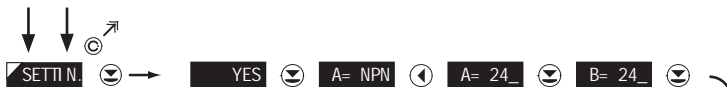

SETTI N.

Automatic setting of the inputs

- it is possible to choose in the menu between automatic or manual setting for input A and B
- for automatic detection the minimum frequency required is 10 Hz

DEF = NPN.CON.

- ⬇ start of automatic input setting
- ⬇ manual input setting - down
- ⬆ manual input setting - up
- ⬇ confirm the setting and proceed to second input (short key stroke)
to copy the setting of Input A to Input B (long key stroke)

In this example application we are using encoder Wenglor, model IB04DBM37VB, type PNP powered by the instrument's own excitation of 24 V, reset on contact. **Settin.** > Automatic setting [button „LEFT“]

Example

A= NPN ⬆ A= 24_ ⬇ B= NPN ⬇ SCAL.C

5. SETTING LIGHT

CHANNEL > "COUNTER"



SCAL.C. Setting multiplying constant
- Channel Counter

- calibration constant serves for calculation of the input value to required display value
- by entering minus value direction of the calculation is changed, i.e. we count down

- range: -0,00001...999999

- **DEF** = 1

Sensor is applied to a shaft equipped with a rotating pin [1 imp./ot] and ratio of 1:3 Example



DI V.C.

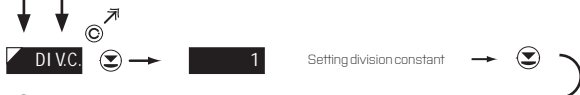

DI V.C.. Setting division constant
- Channel Counter

- calibration constant is for calculation of the input value to required display value
- range: -0,00001...999999

- **DEF** = 1

Sensor is applied to a shaft equipped with a rotating pin [1 imp./ot] and ratio of 1:3 Example

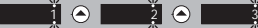

OFF.C.

OFF.C. Setting PRESET

0

Setting additional constant - PRESET, Channel Counter

- offset of the measuring by a set value, which shall be loaded always upon instrument resetting
- range: -99999..999999
- [+ time formats]

- when in mode „STOPWATCH“ and constant > 0 the mathematical symbol [+] of the multiplication constant changes automatically (page. 54)
- **DEF** = 0

Setting „OFF. C.“ = 24 Example

FORM.C. Selection of projection format - Channel Counter

- instrument enables classical projection of number with fixed position of decimal point as well as projection with floating allowing fo projection of number in its most precise form „FLOA. P.“

- for measuring modes „TIME“ and „RTC“ special time formats are preset

DEF = 000000

DEF = HH:MM:SS **H**

Projection of DP on display > 000000 Example

000000 SCAL.F.

000000 00000o 0000oo 000ooo 00oooo 0ooooo FLOA.P.

HHMMSS 99MMSS HHMM HHHMM MMMSS MMSSCC 99SSCC HMMSSC

H

5. SETTING LIGHT

CHANNEL > "FREQUENCY"

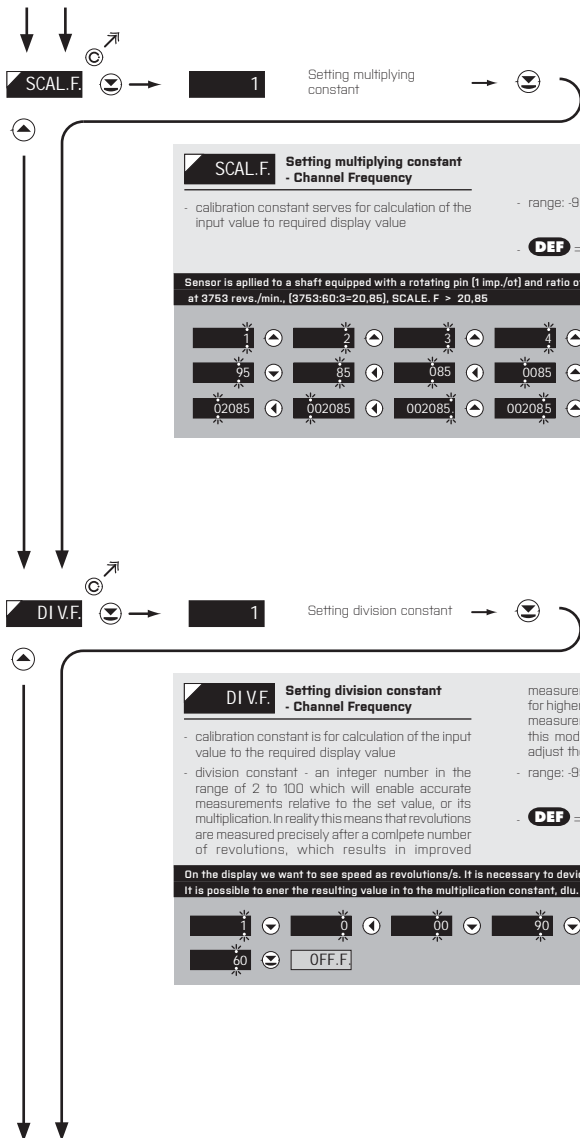

SCAL.F. Setting multiplying constant
- Channel Frequency

- calibration constant serves for calculation of the input value to required display value
- range: 99999...999999
- **DEF** = 1

Sensor is applied to a shaft equipped with a rotating pin (1 imp./ot) and ratio of 1:3 which is rotating at 3753 revs./min., (3753:80:3=20,85). SCALE. F > 20,85

1	2	3	4	5	05
95	85	085	0085	1085	2085
02085	002085	002085	002085	002085	DI V.F.

DIV.F. Setting division constant
- Channel Frequency

- calibration constant is for calculation of the input value to the required display value
- division constant - an integer number in the range of 2 to 100 which will enable accurate measurements relative to the set value, or its multiplication. In reality this means that revolutions are measured precisely after a complete number of revolutions, which results in improved measurement stability. This mode is not suitable for higher frequencies, where it can increase the measurement period. If you do not wish to use this mode, use a decimal number instead and adjust the multiplication constant appropriately
- range: 99999...999999
- **DEF** = 1

On the display we want to see speed as revolutions/s. It is necessary to divide the figure by 60 (1 minute=60 s). Example: It is possible to enter the resulting value in to the multiplication constant, dlu. F. > 60

1	0	00	90	80	70
60	OFF.F.				

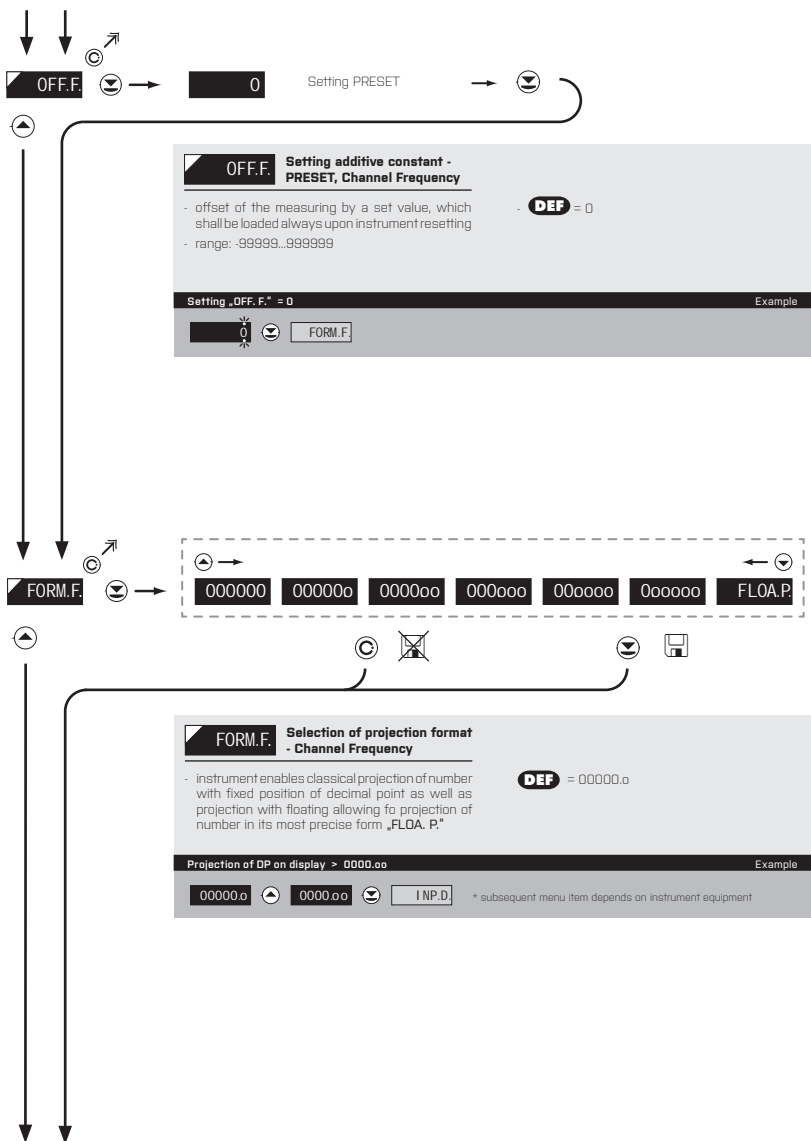

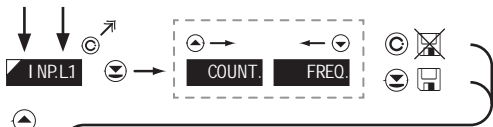

I NP.L1 Selection of how Limit 1 is evaluated

- selection of value to which the limit is related

DEF = COUNT.

COUNT. From "Channel Counter"

FREQ. From "Channel Frequency"

Evaluation of the limit related to channel "Counter" > I NP.L1 = COUNT. Example

COUNT. U M.L1

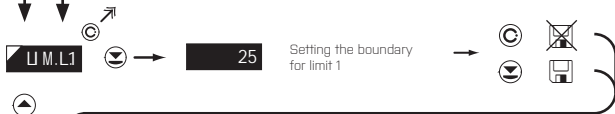

U M.L1 Setting the boundary for limit 1

- range: -99999...999999

- contingent modification of hysteresis or delay may be performed in 'PROF' menu

DEF = 25

DEF ,Hysteresis'=0, ,Delay'=0

Example

Setting limit 1 > LIM.L1 = 30

25

26

27

28

29

20

I NP.L2

* subsequent menu item depends on instrument equipment

!

Items for "Limits" and "Analog output" are accessible only if the instrument contains them

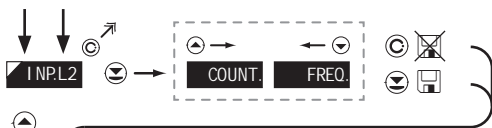

INP.L.2 Selection of how Limit 2 is evaluated

- selection of value to which the limit is related

DEF = COUNT.

COUNT. From "Channel Counter"

FREQ. From "Channel Frequency" Z "Kanálu Kmitočet"

Evaluation of the limit related to channel "Counter" > INP.L.2 = COUNT. Example

COUNT. U M.L.2

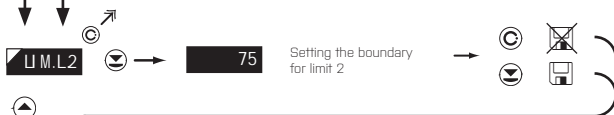

U M.L.2 Setting the boundary for limit 2

- range: -99999..999999

- contingent modification of hysteresis or delay may be performed in 'PROF' menu

DEF = 75

DEF ,Hysteresis'=0, ,Delay'=0

Setting limit 2 > LIM.L.2 = 230 Example

100 110 120 130

230 INP.D. * subsequent menu item depends on instrument equipment

5. SETTING LIGHT

DISPLAYED ONLY WITH OPTIONS > ANALOG OUTPUT

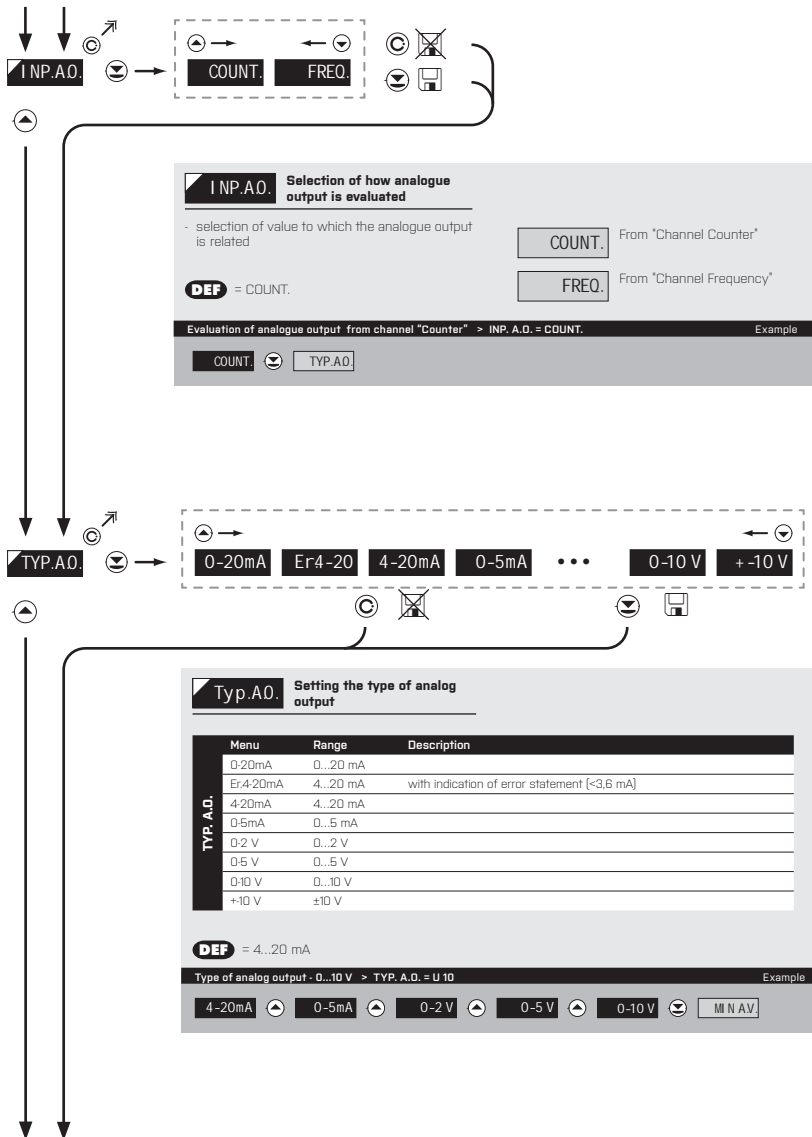

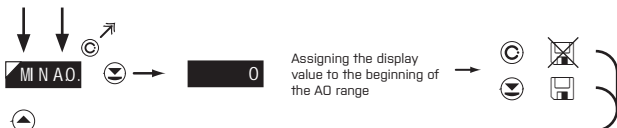

MIN A.O. Assigning the display value to the beginning of the AD range

range

- range: -99999...999999 **DEF** = 0

Display value for the beginning of the AD range > MIN A.O. = 0 Example

0

MAX A.O.

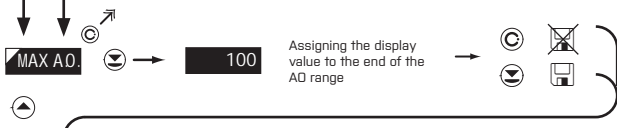

MAX A.O. Assigning the display value to the end of the AD range

- range: -99999...999999 **DEF** = 100

Display value for the end of the AD range > MAX A.O. = 120 Example

100 100 110 120 I N P.D.

!
Items for "Limits" and "Analog output" are accessible only if the instrument contains them

5. SETTING LIGHT

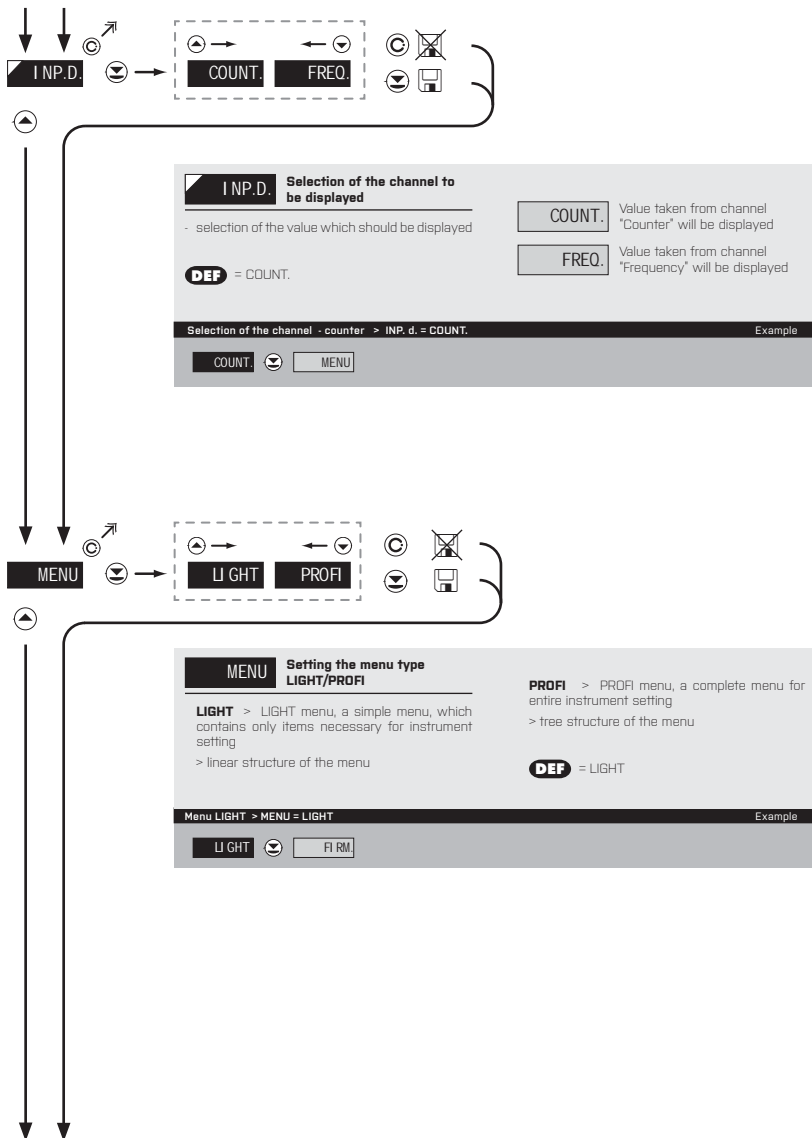

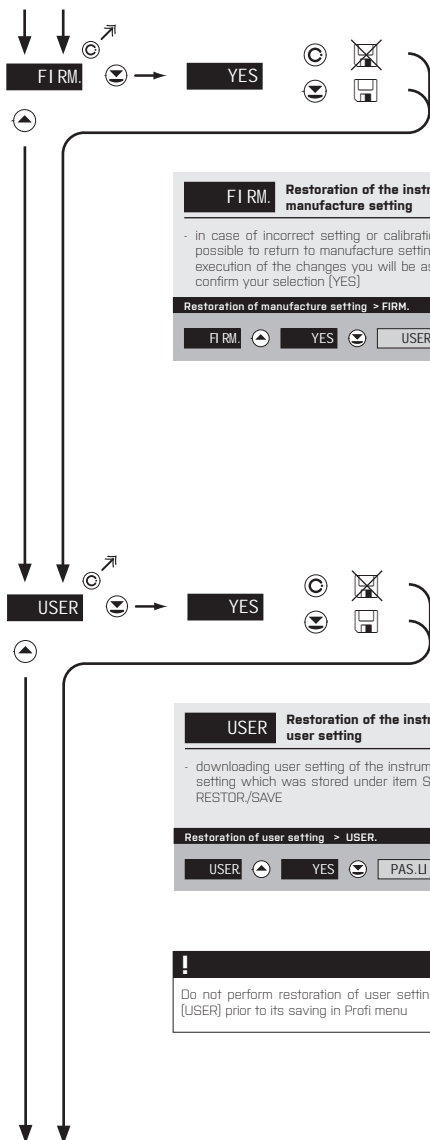

5. SETTING LIGHT

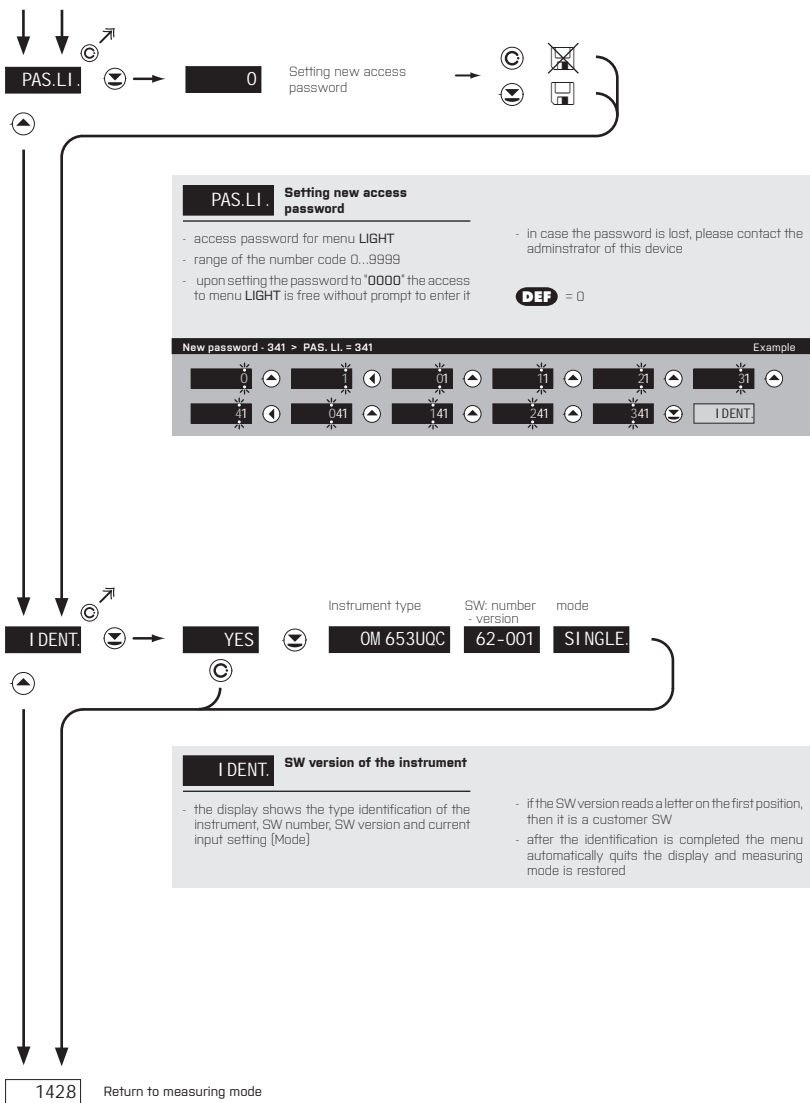





SETTING **PROFI**

For expert users

Complete instrument menu

Access is password protected

Possibility to arrange items of the **USER MENU**

Tree menu structure

6.0 SETTING "PROFI"

PROFI

Complete programming menu

- contains complete instrument menu and is protected by optional number code
- designed for expert users
- preset from manufacture is menu **LIGHT**

Switching over to "PROFI" menu



- access to **PROFI** menu
- authorization for access to **PROFI** menu does not depend on setting under item **SERVIC.** > **MENU**
- password protected access (unless set as follows under the item **SERVIC.** > **N. PASS.** > **PROFI=0**)



- access to menu selected under item **SERVIC.** > **MENU** > **LIGHT/PROFI**
- password protected access (unless set as follows under the item **SERVIC.** > **N. PASS.** > **LIGHT=0**)
- for access to **LIGHT** menu passwords for **LIGHT** and **PROFI** menu may be used



6. SETTING PROFI

6.1 SETTING "PROFI" - INPUT

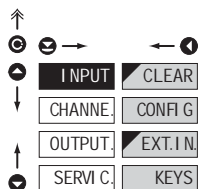

The basic instrument parameters are set in this menu

CLEAR	Resetting internal values
CONFI G	Primary instrument setting
EXT. I N	Setting the external input function
KEYS	Setting the ENTER key function

6.1.1 RESETTING INTERNAL VALUES

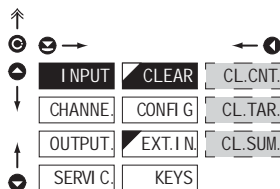

CLEAR	Resetting internal values
CL.CNT	Counter resetting
CL.TAR	Tare resetting
CL.SUM	Zeroing of the sum

- when zeroed, the figure on the display will be added to the total sum („grand total”), a value which is stored in the instrument’s internal memory

- summation is used for cumulated values (i.e. factory shifts) when values from individual shifts are added to the total sum

6.1.2 INSTRUMENT CONFIGURATION

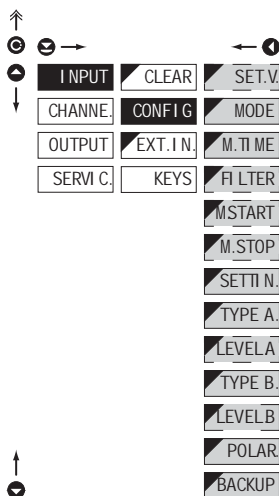

CONF I G Primary instrument setting

SET.V.	Setting the initial value
MODE	Setting the instrument measuring mode
M. T I M E	Setting the time base
F I L T E R	Setting the input filtration constant
MSTART	Setting the stopwatch control
M.STOP	Setting stopwatch resetting
Set t i n.	Automatic setting of the inputs
TYPE -	Setting the type of input
LEVEL -	Setting the input level
POLAR	Selection of active level/edge
BACKUP	Setting data backup/time

6.1.2a SETTING THE INITIAL VALUE

C H

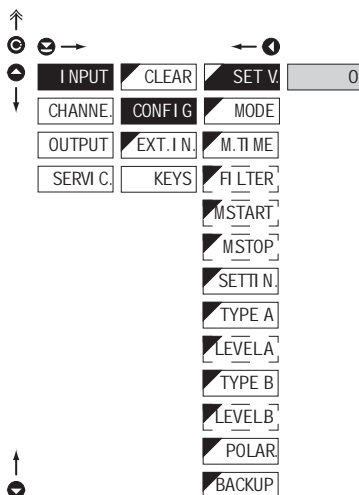

SET.V. Setting the initial value

- allows the user to enter a non-zero, actual value (for example when an old counter needs to be replaced while the count needs to be transferred into a new meter)

6. SETTING PROFI

Programming sche

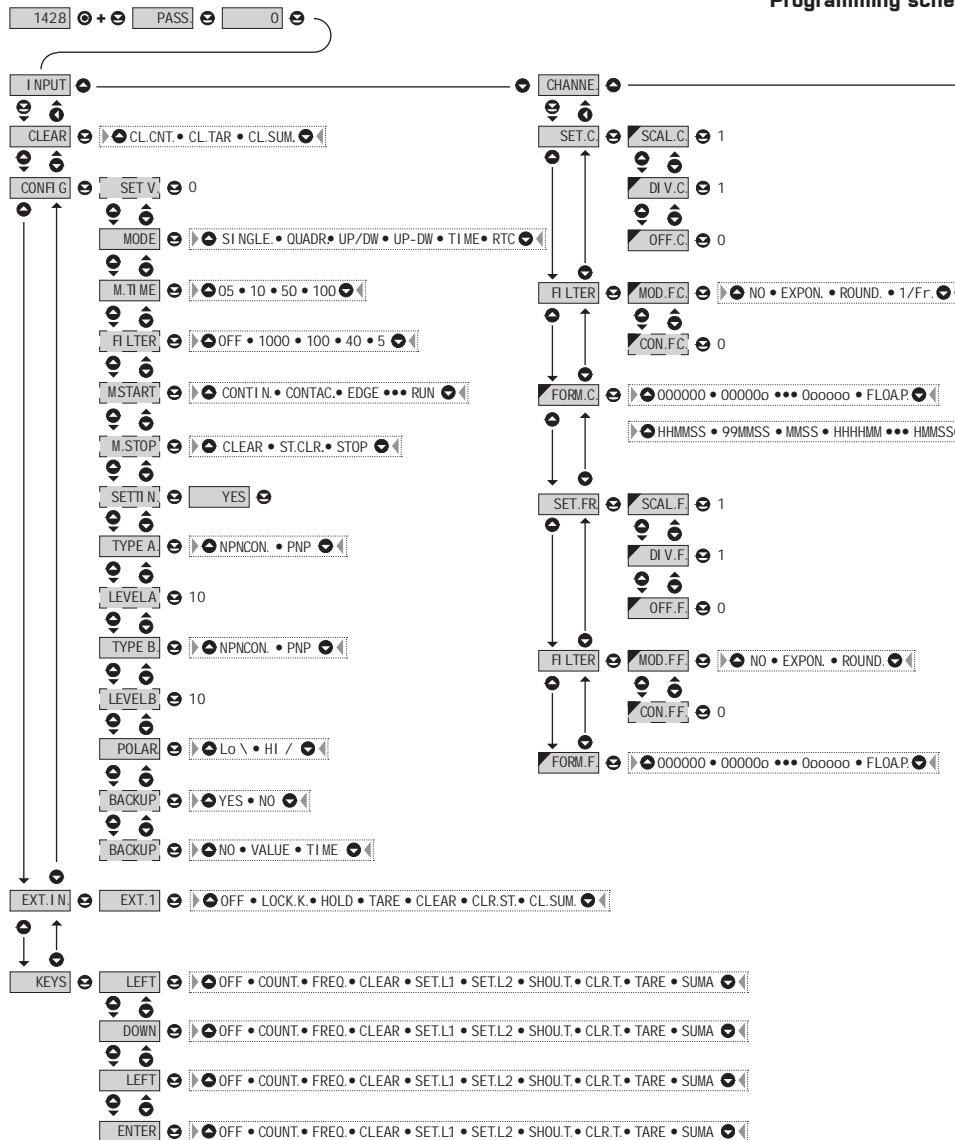

me of PROFI MENU

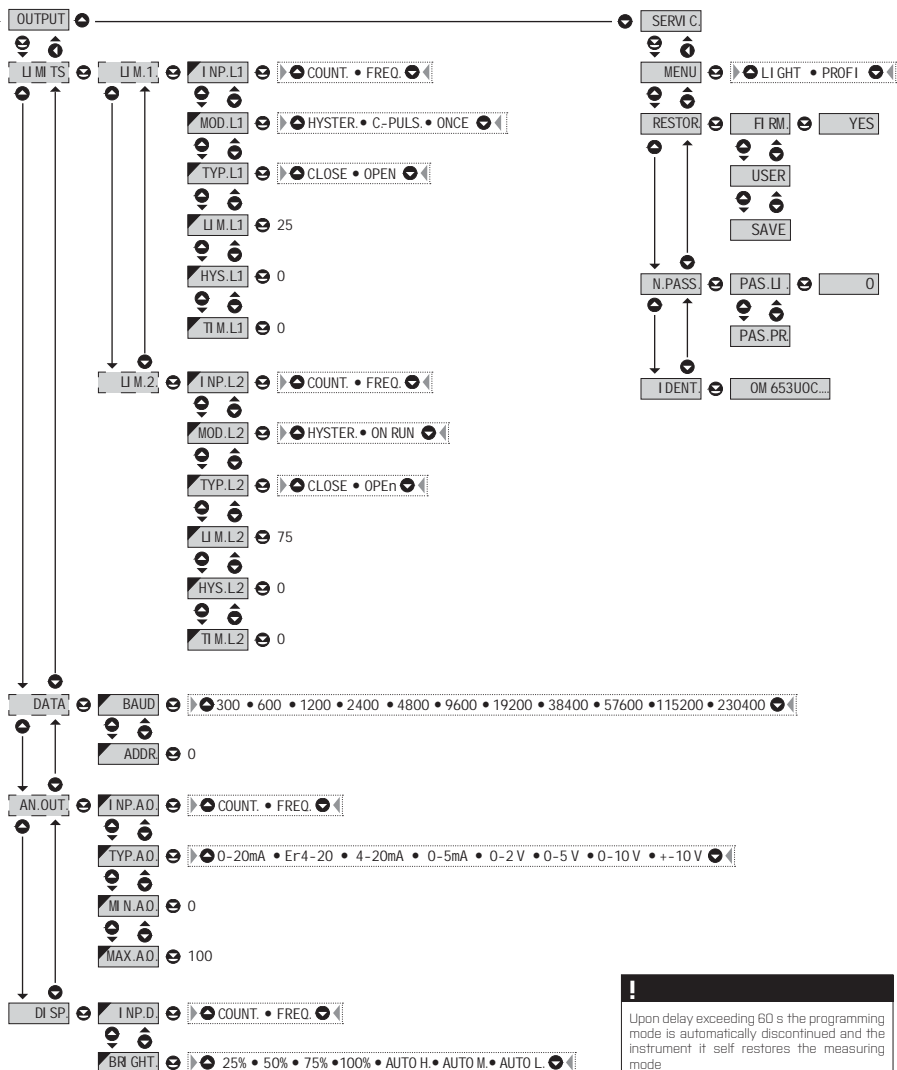

Upon delay exceeding 60 s the programming mode is automatically discontinued and the instrument itself restores the measuring mode

6. SETTING PROFI

6.1.2b

SELECTION OF MEASURING MODE

Navigation icons: ↑, ←, →, ↓, C, M, DEF

INPUT	CLEAR	SET.V.	SINGLE	DEF
CHANNE.	CONFIG	MODE	QUADR.	
OUTPUT.	EXTI N.	M.TI ME	UP/DW	
SERVIC.	KEYS	FIL TER	UP-DW	
		MSTART	TI ME	
		MSTOP	RTC	
		SETTI N.		
		TYPE A		
		LEVEL A		
		TYPE B		
		LEVEL B		
		POLAR		
		BACKUP		

MODE

Selection of instrument measuring mode

SINGLE

Impulse counter/Frequency measurement

QUADR.

Impulse counter/Frequency measurement for IRC encoders

encoders

- measurement on two inputs (ABB). Can display count and frequency
- in this mode every single rising edge of singular A and B is included in the count

UP/DW

UP/DW Impulse counter/Frequency meter

- measurement on input A, (inp. B/direction). Can display count and frequency

UP-DW.

UP-DW Impulse counter/Frequency meter

- measures on inputs A (UP), B (DW). Can display count and frequency

TI ME

Mode „Stopwatch/timer“

RTC

Mode „Stopwatch/timer“ with RTC backup

- not in standard equipment

6.1.2c

SELECTION OF MEASURING PERIOD/TIME BASE

Navigation icons: ↑, ←, →, ↓, C, M, DEF

INPUT	CLEAR	SET.V.	05	DEF
CHANNE.	CONFIG	MODE	1.0	
OUTPUT.	EXTI N.	M.TI ME	5.0	
SERVIC.	KEYS	FIL TER	10.0	
		MSTART		
		MSTOP		
		SETTI N.		
		TYPE A		
		LEVEL A		
		TYPE B		
		LEVEL B		
		POLAR		
		BACKUP		

M.TI ME

Selection of measuring period/time base

- if you set measuring period e.g. for 1 s, the measuring runs approximately from 1 s to 2 s (1 s + maximum one cycle of measured signal). If no signal arrives within 2 s it is taken that the signal has zero frequency
- range of setting of the time base is 0,5 s to 10 s
- in the „RTC“ regime with data projection the set time defines the cycle of switching between time/date, min. is 5 s, date is displayed for approx. 2,5 s

6.1.2d

SELECTION OF INPUT FILTER PARAMETERS

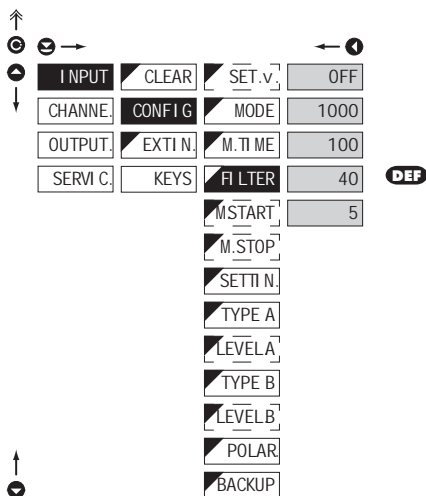
**F I L T E R****Selection of digital input filter**

- digital filter may suppress unwanted interfering impulses (e.g. relay backswings) on the input signal. The set parameter gives maximum possible frequency (Hz) of the instrument, which the instrument w/o limitation
- for pulse duty cycle of 50% - equal duration of Hi and Lo level
- in case if interference the use of input filter is recommended



When accessing upon contact and available maximum input frequency we recommend using filter

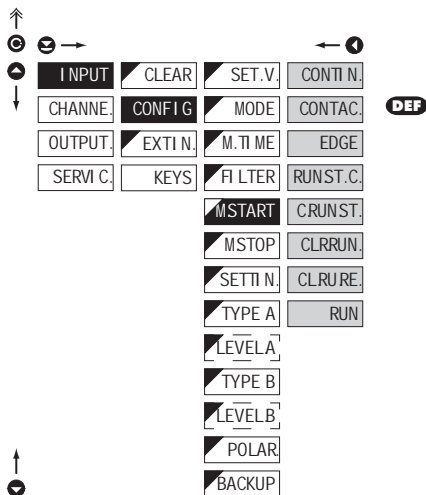

MSTART Selection of stopwatch/timer control

- time setting menu is accessible only in the stopwatch/timer regime

CONTI.N Stopwatch/timer is running constantly if the instrument is turned on

CONTAC Stopwatch/timer is running upon contact making

EDGE Stopwatch/timer is controlled by the priming signal edge

- time is set off by the edge (by the signal passing across the comparing level) and stopped by the next edge

RUn.STC Stopwatch/timer is controlled and reset by the edge of the priming signal

- time is set off by the edge (by the signal passing across the comparing level) and stopped by the next edge

CRUn.ST Stopwatch/timer is controlled and reset by the edge of the priming signal

- time is set off by the edge (by the signal passing across the comparing level) and stopped by the next edge

CLRRUN Stopwatch/timer is reset and set off by the edge of the priming signal (when the time is not running)

CLRURE Stopwatch/timer is reset and set off by the edge of the priming signal, the cycle is repeated with every other edge

- regardless of whether the time is running or not

RUN Stopwatch/timer is only set off by the edge

6.1.2f SELECTION OF STOPWATCH/TIMER RESETTING

H

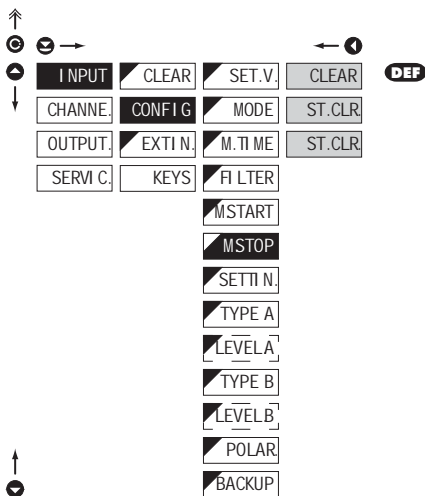
**M.STOP** Selection of stopwatch resetting

- menu of the resetting option is accessible only in the stopwatch/timer regime

CLEAR

Stopwatch/timer is reset through input „Clear“

ST.CLR

Stopwatch/timer is stopped and reset through input „Clear“

STOP

Stopwatch/timer is stopped through input „Clear“

6.1.2g AUTOMATIC SETTING OF THE INPUTS

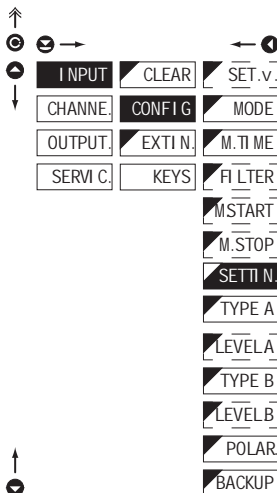
**SETTI N.** Automatic setting of the inputs

- it is possible to choose in the menu between automatic or manual setting for input A and B
- for automatic detection the minimum frequency required is 10 Hz

Ⓜ start of automatic input setting

Ⓜ manual input setting - down

Ⓜ manual input setting - up

Ⓜ confirm the setting and proceed to second input [short key stroke] to copy the setting of Input A to Input B [long key stroke]

DEF = NPN.CON

6. SETTING PROFI

6.1.2h SELECTION OF THE TYPE OF INPUT

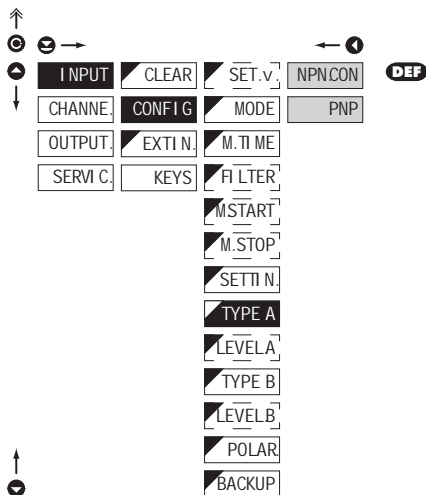

TYPE A Selection of type of input

- setting applies for input A

NPNCON Type of input NPN and upon contact

PNP Type of input PNP

! After selecting "PNP" it is necessary to set the input input level (Level A)

! Setting for input Resetting (Level B) is identical with setting for input A

6.1.2i SETTING INPUT LEVEL

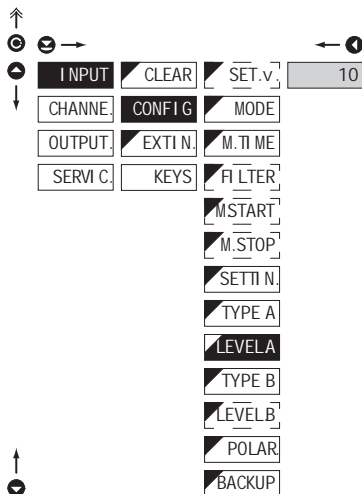

LEVEL A Setting input level

- setting applies for input A
- setting level (only for type PNP) of the input voltage, the instrument subsequently automatically selects divider and thus comparing levels
- range of setting 0...43 V
[Input A < 30 V, bracket No. 12]
[Input B < 30 V, bracket No. 13]
- range of setting 43...300 V
[Input A < 300 V, bracket No. 17]
[Input B < 300 V, bracket No. 15]
- table of comparing levels is on page 8

! Setting for input Resetting (Level B) is identical with setting for input A

6.1.2j SELECTION OF ACTIVE LEVEL OR EDGE

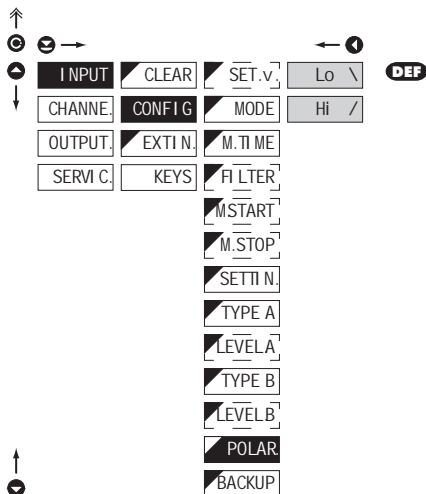
**POLAR** Selection of active level or edge

Lo \ Active upon change of declining edge Lo → Hi

- upon entering the contact > active on switch-on

Hi / Active upon change of entering edge Hi > Lo

- upon entering the contact > active on switch-off

6.1.2k SELECTION OF DISPLAY STATUS BACKUP

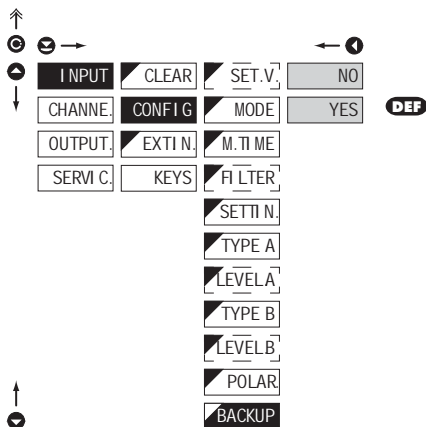
**BACKUP** Selection of display status backup

- setting display value restoration after power failure or instrument switch-off

NO After switch-on the instrument loads the display status from the memory

YES Instrument resets itself after switch-on

6. SETTING PROFI

6.1.2I

SETTING THE DISPLAY STATUS BACKUP

H

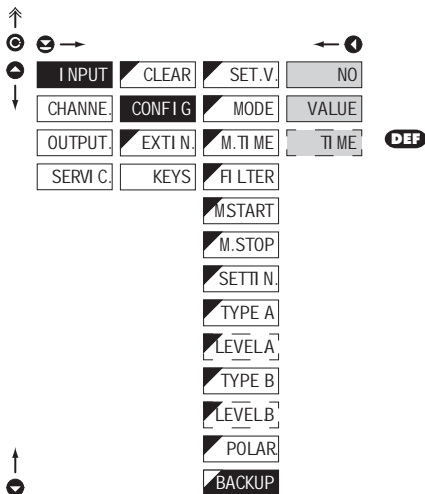

BACKUP Setting the display status backup

- time setting menu is accessible only in the stopwatch/timer regime
- setting display value restoration after power failure or instrument switch-off

NO Instrument resets itself after every switch-on

VALUE After switch-on the instrument loads the display status from the memory

TI ME Instrument downloads „running“ time from RTC

- item accessible only with extension „Time backup“

6.1.3 EXTERNAL INPUT FUNCTION SELECTION

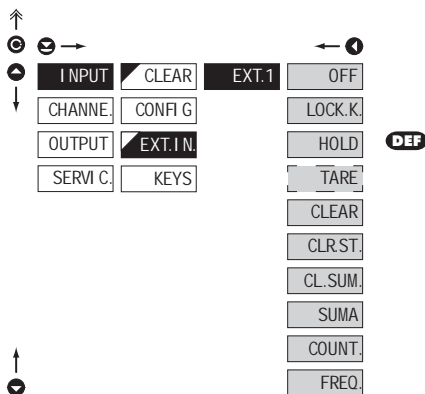

Response time to the change of input is approx 100 ms

EXT. I.N. External input function selection

- OFF** Input is off
- LOCK.K.** Auxiliary input governs the „LOCK“ function
- the input governs the blocking of control keys on front panel
- HOLD** Auxiliary input governs the „HOLD“ function
- the input governs the HOLD function, which blocks all instrument functions
- TARE** Auxiliary input governs the „TARE“ function
- the TARE function is activated through the input, only in the "Frequency" mode
- CLEAR** Auxiliary input governs the „Clear“ function
- stopwatch/counter is cleared (preset) through the input
- CLR.St.** Auxiliary input governs the „Clear“ function
- stopwatch/counter is cleared (preset) through the input, Stopwatch stops altogether
- CL.SUM.** Auxiliary input governs the „Clear Sum“ function*
- the "grand total" of the counter is zeroed
- SUMA** Auxiliary input governs the „SUM“ function
- the cumulated value is displayed
- COUNT.** Auxiliary input governs the counter display
- the value of "Counter" channel is displayed
- FREQ.** Auxiliary input governs the frequency display
- the value of "Frequency" channel is displayed

6. SETTING PROFI

6.1.4 OPTIONAL ACCESSORY FUNCTIONS OF THE KEYS

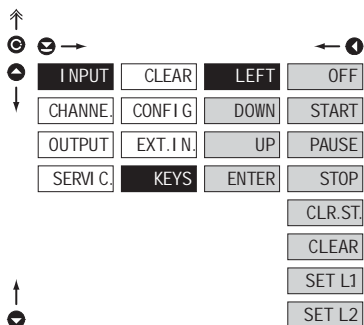
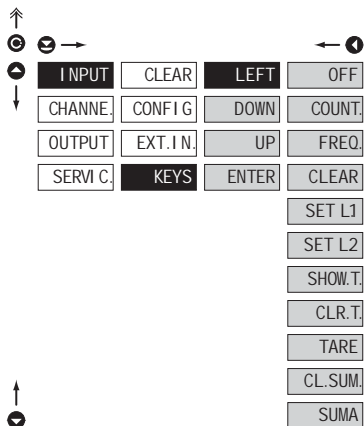

KEYS Assigning accessory functions of control keys

- this setting is identical for all control keys

OFF	Accessory functions are off
COUNT.	Displays value from channel "Counter"
FREQ.	Displays value from channel "Frequency"
CLEAR	Clears Counter
SET.L.-	Setting limit L1, resp. L2
SHOV.T.	Shows TARE
CLR.T.	Clears TARE
TARA	Activates function TARE
CL.SUM.	Clears the total sum
SUMA	Displays the total sum (grand total)

KEYS Assigning accessory functions of control keys

- can be used only in mode "TIME" and "RTC"
- this setting is identical for all control keys

OFF	Accessory functions are off
START	Start - stopwatch/clock
PAUSE	Pause - stopwatch/clock
STOP	Stop - stopwatch/clock
CLR.ST.	Stop and clear - stopwatch/clock
CLEAR	Clear - stopwatch/clock
SET.L.-	Setting limit L1, resp. L2

- leaves the current value displayed until a new key stroke
- dot/dots indicate the stopwatch is running by flashing



6. SETTING PROFI

6.2 SETTING "PROFI" - CHANNEL

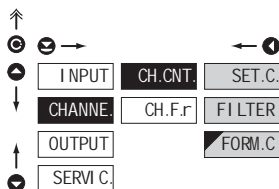

In this menu the instrument input parameters are set

- SET.C.** Setting calibration constant
- FI LTER** Setting the digital filters
- FORM.C.** Selection of projection format

6.2.1a SETTING MULTIPLYING CONSTANT - CHANNEL COUNTER

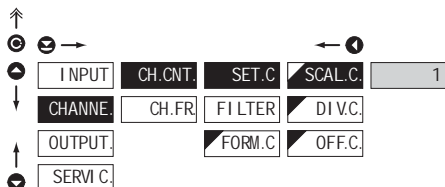

SCAL.C. Setting multiplying constant - Counter

- multiplying constant serves for calculation of input value to required display value
- by entering minus value the direction of calculation is changed, i.e. we count down
- range: -0,00001...999999
- **DEF** = 1

! **H**

If non-zero value is set in the "TIME" or "RTC" mode in the "OFF.C." item, it applies that the multiplying constant "SCAL.C." is negative

6.2.1b SETTING DIVISION CONSTANT - CHANNEL COUNTER

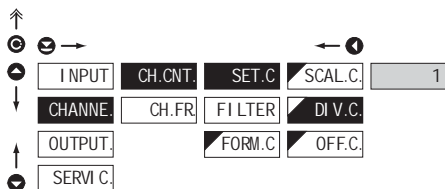

DI V.C. Setting division constant - Counter

- division constant serves for calculation of input value to required display value
- range: 0,00001...999999
- **DEF** = 1

*

Revolution measurement function

If you set the division constant (invariable) for channel Ch. Fr. as an integer number [range 1..255], the measurement will be realised according to the preset multiplications of revolutions/pulses. In reality this means that revolutions are measured precisely after a number of revolutions have been fully completed, which results in an improved stability of the measured value. This mode is not suitable for higher frequencies, where it can increase the measurement period. If you do not wish to use this mode, use a decimal number instead and adjust the multiplication constant appropriately. Please pay attention to the time platform (TIME 1), which must allow for adding up the 1..255 pulses within the set time period. ATTN! When this option is used in the QUADR mode, it may result in an error when the direction of revolution is reversed.

6.2.1c SETTING ADDITIVE CONSTANT - PRESET, CHANNEL COUNTER

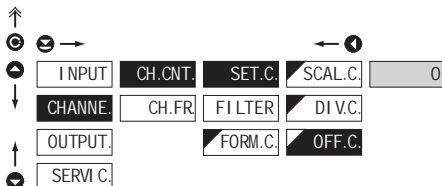
**OFF.C.** Setting PRESET constant - Counter

- offset of the measuring by a set value, which shall be loaded always upon instrument resetting
- range: :99999...999999

- **DEF** = 0

H

If non-zero value is set in the "TIME" or "RTC" mode in the "OFF.C." item, it applies that the multiplying constant "SCAL.C." is negative

6.2.2 SETTING THE DIGITAL FILTERS - CHANNEL COUNTER

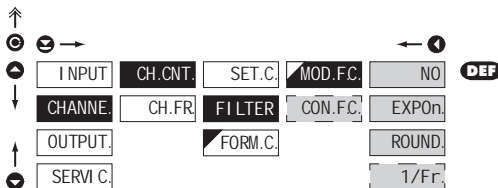
**FI LTER** Setting the digital filters - Counter

CON.F.C. Setting the constant

- this menu item is always displayed after selection of a particular type of filter

- **DEF** = 2

NO Filters are switched off

EXPON. Selection of exponential filter

- calculation of value from the number of measurements selected in „CON.F.C.“

ROUND. Selection of value round-up

- it is set by arbitrary number, which determines the projection step [e.g.: "Con.F.C."=2,5 > display 0, 2,5, 5,...]

1/Fr. A filter which converts frequency to time

H

Identical setting is used for "CH. Fr."

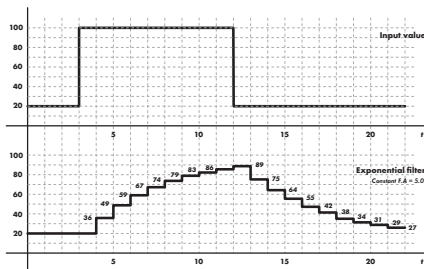



6. SETTING PROFI

6.3 SETTING „PROFI“ - OUTPUTS

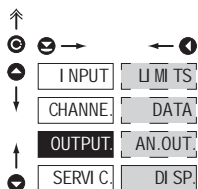

It is possible to set the parameters of the instrument output signals in this menu

LIMITS	Setting the type and the switching of limits
DATA	Setting the type and the parameters of data output
AN.OUT.	Setting the type and parameters of analog output
DI.SP.	Setting the display brightness

6.3.1a SELECTION OF HOW LIMIT 1 IS EVALUATED

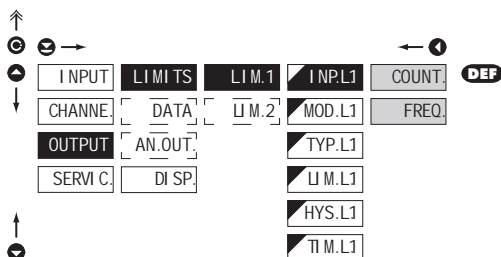

I NP.L1 Selection of how Limit 1 is evaluated

- selection of value to which the limit is related

COUNT.	From "Channel Counter"
FREQ.	From "Channel Frequency"

6.3.1b SELECTION OF MODE OF OUTPUT L 1

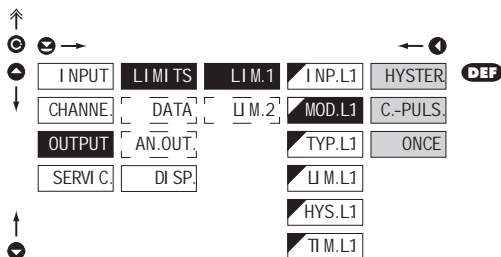

MOD.L1 Mode of limit 1

HYSTER.	Standard mode - limit, hysteresis and delay
C.-PULS.	Automatic zeroing of the counter at a preset value and a generating an impulse of duration set in "TIM.L1"
ONCE	The relay will be activated once and will remain in the activated position until the counter is re-set.

!
Setting is available only for LIM 1

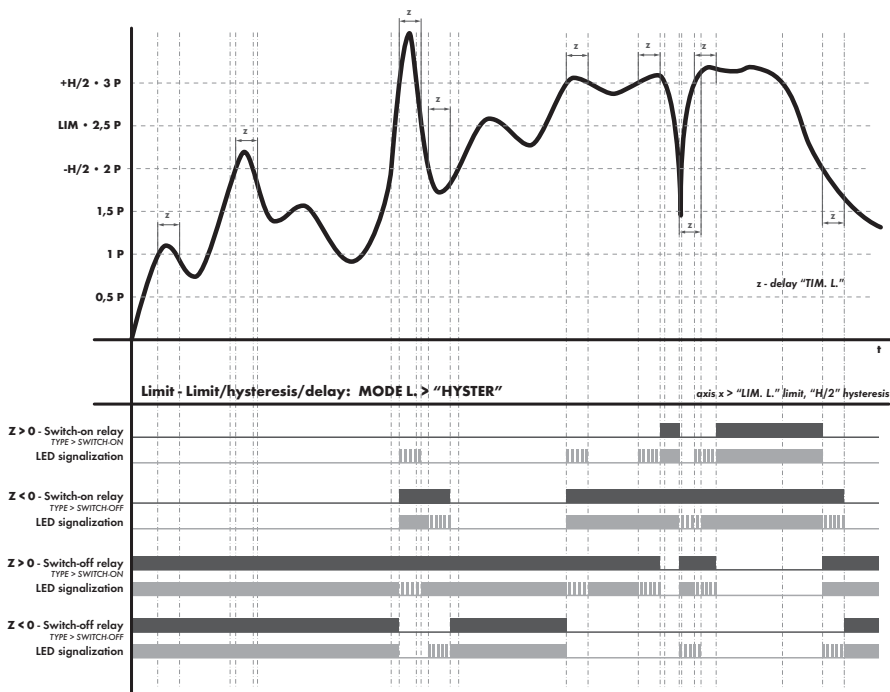

6.3.1c SELECTION OF MODE OF OUTPUT L 2

Navigation icons: ↑, Ⓞ, →, ←, Ⓞ, ↓, ↑, Ⓞ

INPUT	LIMITS	U M.1	INP.L2	HYSTER	DEF
CHANNE	DATA	LIM.2	MOD.L2	ON RUN	
OUTPUT	AN.OUT		TYP.L2		
SERVI.C	DI.SP		U M.L2		
			HYS.L2		
			TIM.L2		

MOD.L2 Mode of limit 2

HYSTER	Standard mode - limit, hysteresis and delay
ON RUN	Relay is switched on/off if the stopwatch is running

! Setting is available only for LIM 2

6. SETTING PROFI

6.3.3d SELECTION OF TYPE OF OUTPUT

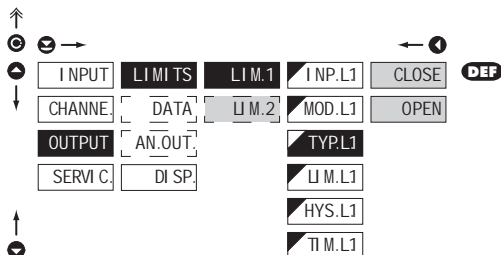

TYP.L1 Setting the type of relay function

CLOSE

Relay switches on when the condition is met

OPEN

Relay switches off when the condition is met

! Setting is identical for LIM 1 and LIM 2

6.3.1e SETTING VALUES FOR LIMITS EVALUATION

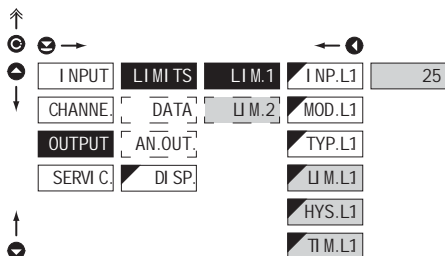

U.M.L1 Setting limit for switch-on

HYS.L1 Setting hysteresis

- defines the band around the limit (on both sides, LIM. $\pm 1/2$ HYS.)

TIM.L1 Setting the time switch-on of the limit

- setting within the range: $\pm 0...99,9$ s
- positive time > relay switches on after crossing the limit (LIM. L1) and the set time (TIM. L1)
- negative time > relay switches off after crossing the limit (LIM. L1) and the set negative time (TIM. L1)

! Setting is identical for LIM 1 and LIM 2

6.3.2a SELECTION OF TRANSMISSION RATE OF DATA OUTPUT

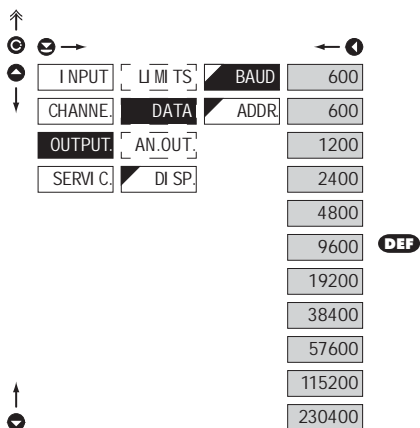

BAUD	Setting the data output rate
300	Rate - 300 Baud
600	Rate - 600 Baud
1200	Rate - 1 200 Baud
2400	Rate - 2 400 Baud
4800	Rate - 4 800 Baud
9600	Rate - 9 600 Baud
19200	Rate - 19 200 Baud
38400	Rate - 38 400 Baud
57600	Rate - 57 600 Baud
115200	Rate - 115 200 Baud
230400	Rate - 230 400 Baud

6.3.2b SETTING THE INSTRUMENT ADDRESS

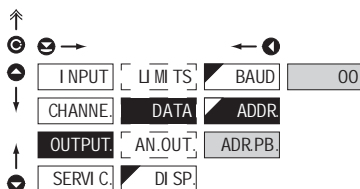

ADDR	Setting the instrument address
- setting within the range 0...31	
- DEF = 00	

ADR.PB	Setting the instrument address - PROFIBUS
- setting within the range 1..127	
- DEF = 19	

6. SETTING PROFI

6.3.3a SELECTION OF HOW ANALOGUE OUTPUT IS EVALUATED

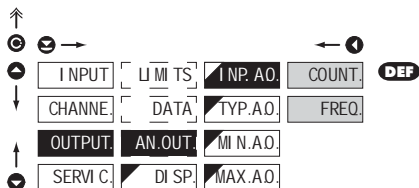

I NP. A.O. Selection of how analogue output is evaluated

- selection of value to which the analogue output is related

COUNT. From "Channel Counter"

FREQ. From "Channel Frequency"

6.3.3b SELECTION OF TYPE OF ANALOG OUTPUT

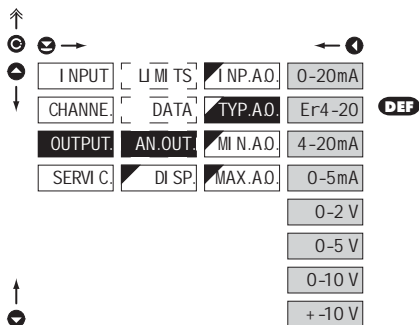

TYP. A.O. Selection of type of analog output

0-20mA Type - 0...20 mA

Er4-20 Type - 4...20 mA

- with indication of error statement (< 3.6 mA)

4-20mA Type - 4...20 mA

0-5mA Type - 0...5 mA

0-2 V Type - 0...2 V

0-5 V Type - 0...5 V

0-10 V Type - 0...10 V

+ -10 V Type - ±10 V

6.3.3c SELECTION OF ANALOG OUTPUT RANGE

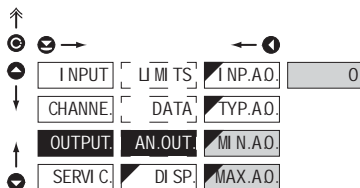
**AN.OUT.** Setting the analog output range

- analog output is isolated and its value corresponds with the displayed data. It is fully programmable, i.e. it allows to assign the AO limit points to any two arbitrary points of the entire measuring range

MI N.A.O. Assigning the displayed value to the beginning of the analog output range

- range: -99999...999999

- **DEF** = 0

MAX.A.O. Assigning the displayed value to the end of the analog output range

- range: -99999...999999

- **DEF** = 100

6.3.4a SELECTION OF THE CHANNEL TO BE DISPLAYED

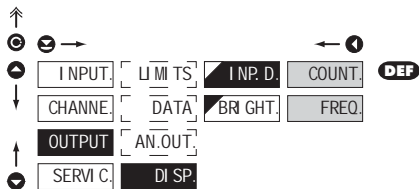
**I NP.D.** Selection of the channel to be displayed

- selection of the value which should be displayed

COUNT. Value taken from channel "Counter" will be displayed

FREQ. Value taken from channel "Frequency" will be displayed

6. SETTING PROFI

6.3.4b SELECTION OF DISPLAY BRIGHTNESS

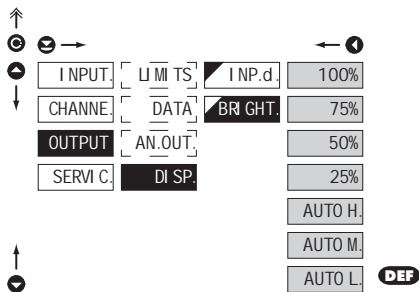

BR GHT. Selection of display brightness

- by selecting the display brightness we may react properly to light conditions in place of location of the instrument

100%	Display brightness - 100%
75%	Display brightness - 75%
50%	Display brightness - 50%
25%	Display brightness - 25%
AUTO H.	Automatic brightness adjustment - High
AUTO M.	Automatic brightness adjustment - Medium
AUTO L.	Automatic brightness adjustment - Low



6. SETTING PROFI

6.4 SETTING "PROFI" - SERVICE

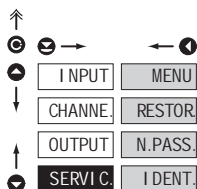

The instrument's service functions are set in this menu

MENU	Selection of menu type LIGHT/PROFI
RESTOR.	Restoration of the manufacture setting and instrument calibration
N.PASS.	Setting new access password
I DENT.	Instrument identification

6.4.1 SELECTION OF THE TYPE OF PROGRAMMING MENU

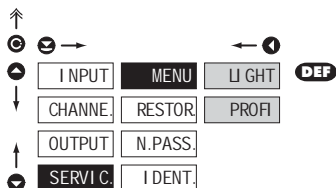

MENU Selection of menu type
LIGHT/PROFI

- allows to set the menu complexity as per user needs and abilities

U GHT Active LIGHT menu

- simple programming menu, contains only items necessary for instrument configuration and setting
- linear menu structure > items in succession

PROFI Active PROFI menu

- complete programming menu for expert users
- tree menu



Change of setting is valid with next access into menu

6.4.2 RESTORATION OF THE MANUFACTURE SETTING

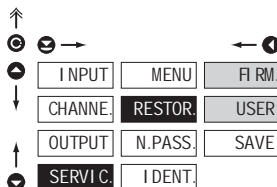

After restoration of setting the instrument switches off for several seconds

RESTOR. Restoration of the instrument manufacture setting

F RM. Return to manufacture setting of the instrument

- downloading manufacture setting for currently selected type of instrument (items described DEF)

USER Return to user setting of the instrument

- downloading user setting of the instrument, i.e. setting which was stored under item SERVI C./RESTOR./SAVE

SAVE Storing user setting of the instrument

- storing the setting enables the operator its future contingent restoration

6.4.3 SETTING NEW ACCESS PASSWORD

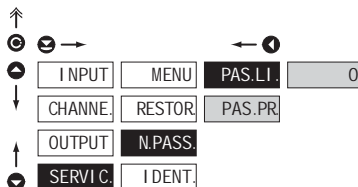

N.PASS. Setting new password for access into the LIGHT and PROFI menu

- this option allows to change the numeric code, which blocks the access into LIGHT and PROFI Menu.

- numeric code range: 0...9999

- universal passwords in the event of loss:
LIGHT Menu > „8177”
PROFI Menu > „7915”

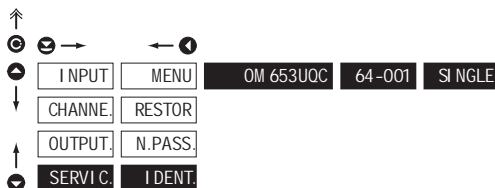
6.4.4 INSTRUMENT IDENTIFICATION

I DENT. Projection of instrument SW version

- the display shows the type identification of the instrument, SW number, SW version and current input setting [Mode]

- if the SW version reads a letter on the first position, then it is a customer SW

	Pos.	Description
I DENT.	1.	type of instrument
	2.	SW number - version
	3.	the input type



SETTING USER

For user operation

Menu items are set by the user (Profi/Light) as per request

Access is not password protected

Optional menu structure either tree (PROFI) or linear (LIGHT)

7.0 SETTING ITEMS INTO "USER" MENU

- **USER** menu is designed for users who need to change only several items of the setting without the option to change the basic instrument setting (e.g. repeated change of limit setting)
- there are no default items from manufacture in **USER** menu
- menu configuration possible on items indicated by inverse triangle  U.M.L1
- setting may be performed in **LIGHT** or **PROFI** menu, with the **USER** menu then overtaking the given menu structure

Setting

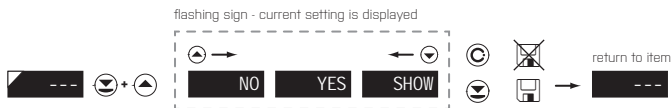

NO

item will not be displayed in USER menu

YES

item will be displayed in USER menu with the option of setting

SHOW

item will be solely displayed in USER menu

Setting sequence of items in "USER" menu

In compiling USER menu from active LIGHT/PROFI menu the items (max. 10) may be assigned a sequence, in which they will be projected in the menu

setting projection sequence



Example of ranking the order of menu items in the "USER" menu

In this example we want to have a direct access to menu items Limit 1 and Limit 2 (example show is for the Light menu, but can equally be used in the Profi menu).

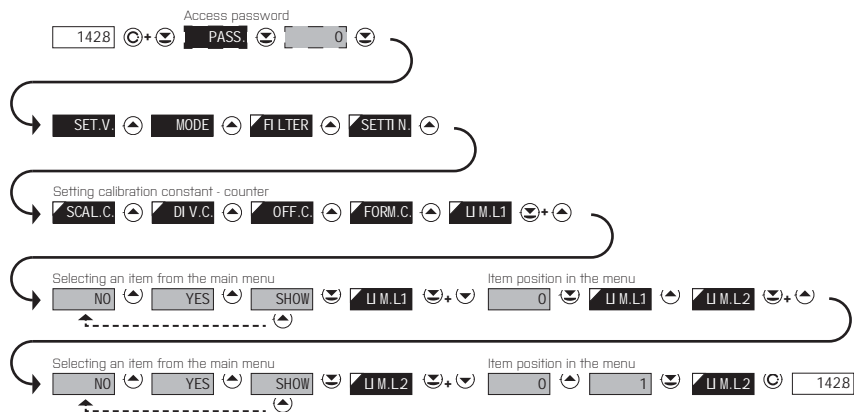

The result of this setting is that when the \odot button is pressed, the display will read „LIM. L.1“. By pressing \odot button you confirm your selection and then you can set the desired limit value, or by pressing the \rightarrow button you can go to setting of „LIM. L.2“ where you can proceed identically as with Limit one.

You can exit the setting by pressing the \odot button by which you store the latest setting and pressing the \odot button will take you back to the measuring mode.

8. DATA PROTOCOL



The instruments communicate via serial line RS232 or RS485. For communication they use the ASCII protocol. Communication runs in the following format:

ASCII: 8 bit, no parity, one stop bit
 DIN MessBus: 7 bit, even parity, one stop bit

The transfer rate is adjustable in the instrument menu. The instrument address is set in the instrument menu in the range of 0 ÷ 31. The manufacture setting always presents the ASCII protocol, rate of 9600 Baud, address 00. The type of line used - RS232 / RS485 - is determined by an output board automatically identified by the instrument.

The commands are described in specifications you can find at www.orbit.merret.cz

DETAILED DESCRIPTION OF COMMUNICATION VIA SERIAL LINE

ACTIVITY	TYPE	PROTOCOL	DATA TRANSFERRED
Data sollicitation (PC)	232	ASCII	# A A <CR>
		MessBus	No - data is transmitted permanently
	485	ASCII	# A A <CR>
		MessBus	<SADR> <END>
Data transmission (instrument)	232	ASCII	> 0 [0] [0] [0] [0] [0] [0] [0] [0] [0] [0] [0] [0] <CR>
		MessBus	<STX> 0 [0] [0] [0] [0] [0] [0] [0] [0] [0] [0] [0] [0] <ETX> <BCC>
	485	ASCII	> 0 [0] [0] [0] [0] [0] [0] [0] [0] [0] [0] [0] [0] <CR>
		MessBus	<STX> 0 [0] [0] [0] [0] [0] [0] [0] [0] [0] [0] [0] [0] <ETX> <BCC>
Confirmation of data acceptance (PC) - OK	485	MessBus	<DLE> 1
Confirmation of data acceptance (PC) - Bad			<NAK>
Sending address (PC) prior command			<EADR> <END>
Confirmation of address (instrument)			<SADR> <END>
Command transmission (PC)	232	ASCII	# A A N P [0] [0] [0] [0] [0] [0] [0] [0] <CR>
		MessBus	<STX> S N P [0] [0] [0] [0] [0] [0] [0] [0] <ETX> <BCC>
	485	ASCII	# A A N P [0] [0] [0] [0] [0] [0] [0] [0] <CR>
		MessBus	<STX> S N P [0] [0] [0] [0] [0] [0] [0] [0] <ETX> <BCC>
Command confirmation (instrument)	232	ASCII	OK A A <CR>
		Bad	? A A <CR>
		Messbus	No - data is transmitted permanently
		Messbus	No - data is transmitted permanently
	485	ASCII	OK A A <CR>
		Bad	? A A <CR>
		MessBus	OK <DLE> 1
		MessBus	<NAK>
Instrument identification			# A A 1 Y <CR>
HW identification			# A A 1 Z <CR>
One-time transmission			# A A 7 X <CR>
Repeated transmission			# A A 8 X <CR>

LEGENDA

SIGN	RANGE	DESCRIPTION
#	35 23 _H	Command beginning
A	A 0...31	Two characters of instrument address (sent in ASCII - tens and units, e.g. "01", "99" universal)
<CR>	13 00 _H	Carriage return
<SP>	32 20 _H	Space
N, P		Number and command - command code
D		Data - usually characters "0".."9", ":", ";", ":", "D" - dp. and [] may prolong data
R	30 _H ..3F _H	Relay and tare status
!	33 21 _H	Positive confirmation of command [ok]
?	63 3F _H	Negative confirmation of command [point]
>	62 3E _H	Beginning of transmitted data
<STX>	2 02 _H	Beginning of text
<ETX>	3 03 _H	End of text
<SADR>	adresa +60 _H	Prompt to send from address
<EADR>	adresa +40 _H	Prompt to accept command at address
<ENQ>	5 05 _H	Terminate address
<DLE>1	16 49 10 _H 31 _H	Confirm correct statement
<NAK>	21 15 _H	Confirm error statement
<BCC>		Check sum -XOR

RELAY, TARE

SIGN	RELAY 1	RELAY 2	TARE	CHANGE RELAY 3/4
P	0	0	0	0
Q	1	0	0	0
R	0	1	0	0
S	1	1	0	0
T	0	0	1	0
U	1	0	1	0
V	0	1	1	0
W	1	1	1	0
p	0	0	0	1
q	1	0	0	1
r	0	1	0	1
s	1	1	0	1
t	0	0	1	1
u	1	0	1	1
v	0	1	1	1
w	1	1	1	1

Relay status is generated by command #A6X <CR>.

The instrument immediately returns the value in the format >HH <CR>, where HH is value in HEX format and range 00H..FFH. The lowest bit stands for „Relay 1“, the highest for „Relay 8“

9. ERROR STATEMENTS



ERROR	CAUSE	ELIMINATION
E.D.Un.	Number is too small (large negative) to be displayed	change DP setting, channel constant
E.D.Ow.	Number is too large to be displayed	change DP setting, channel constant
E.T.Un.	Number is outside the table range	increase the table values, change input setting (channel constant)
E.T.Ow.	Number is outside the table range	increase the table values, change input setting (channel constant)
E.V.Un.	Input quantity is smaller than permitted input quantity range	change input signal value or input [range] setting
E.V.Ow.	Input quantity is larger than permitted input quantity range	change input signal value or input [range] setting
E.HW.	A part of the instrument does not work properly	send the instrument for repair
E.EE.	Data in EEPROM corrupted	perform restoration of manufacture setting, upon repeated error statement send instrument for repair
E.SET.	Data in EEPROM outside the range	perform restoration of manufacture setting, upon repeated error statement send instrument for repair
E.CLR.	Memory was empty (presetting carried out)	upon repeated error statement send instrument for repair, possible failure in calibration



10. TECHNICAL DATA



INPUT

Type:	upon contact, TTL, NPN/PNP
Measuring:	1x counter/frequency UP or DOWN 1x counter/frequency UP/DOWN 1x counter/frequency for IRC sensor 1x stopwatch/timer - measuring range isadjustable
Input frequency:	0,1..50 kHz [Mode SINGLE] 0,1..20 kHz [Mode UP/DW] 0,1..20 kHz [Mode UP-DW] 0,1..20 kHz [Mode QUADR. - Frequency] 0,1..10 kHz [Mode QUADR. - Counter] [for frequency duty cycle of 50 %]
Voltage levels	9,7 - 14,4 - 19,2 - 23,9 - 28,7 - 33,5 - 38,3 - 43,0 V 84 - 128 - 170 - 211 - 253 - 295 - 301 V

PROJECTION

Display:	999999, intensive red or green 7-segment LED, digit height 14 mm
Projection:	-99999...999999
Decimal point:	adjustable - in programming mode
Brightness:	adjustable - in programming mode

INSTRUMENT ACCURACY

Temperature coef:	50 ppm/°C
Accuracy:	±0,02 % of the range + 1 digit [frequency]
Time base:	0,5/1/5/10 s
Multiplying const:	±0,00001...999999
Division constant:	±0,00001...999999
Filtration constant:	allows for setting max. valid frequency, which is processed [OFF/5...1000 Hz]
Type of filter:	digital
Preset:	-99999...999999
Data backup:	preservation of measured data even after instrument switch-off [EEPROM]
Functions:	Tare - display resetting Summation-(grandtotal)registrofshifts Hold - stop measuring (upon contact) Lock - control keys locking
RTC:	the course of time is backed up by battery upon disconnection from the instrument supply [may be turned off - jumper inside the instrument]
Battery:	Lithium cell CR 2032RV, 3V/220 mAh minimum lifetime 1 year
OM Link:	Company communication interface for instrument operation, setting and update
Watch-dog:	reset after 540 ms
Calibration:	pH 25°C a 40 % r.v.

COMPARATOR

Type:	digital, adjustable in the menu
Rate switching:	< 50 ms
Mode:	Hysteresis, Once, C-Puls, On Run
Limits:	-99999...999999
Hysteresis:	0...999999
Delay:	0...99,9 s
Outputs:	2x relays with switch-on contact [Form A] [250 VAC/30 VDC, 3 A]* 2x open collector [30 VDC/100 mA]
Relays:	1/8 HP 277 VAC, 1/10 HP 125 V, Pilot Duty D300

DATA OUTPUTS

Protocols:	ASCII, PROFIBUS
Data format:	8 bit + no parity + 1 stop bit
Rate:	600...230 400 Baud 9 600 Baud...12 Mbaud [PROFIBUS]
RS 232:	isolated, two-way communication
RS 485:	isolated, two-way communication, addressing [max. 31 instruments]
PROFIBUS:	Data protocol SIEMENS

ANALOG OUTPUTS

Type:	isolated, programmable with 12-bit D/A converter, type and range are selectable in programming mode
Non-linearity:	0,1% of the range
TC:	15 ppm/°C
Rate:	response to change of value < 1 ms
Voltage:	0...2 V/5 V/10 V/±10 V
Current:	0...5/20 mA/4...20 mA - compensation of conduct up to 500 Ω/12 V

EXCITATION

Adjustable:	5...24 VDC/max. 1,2 W, isolated
-------------	---------------------------------

POWER SUPPLY

Option:	10...30 V AC/DC, 13,5 VA, isolated, PF ≥ 0,4 - fuse inside [T 4000 mA] 80...250 V AC/DC, 13,5 VA, isolated, PF ≥ 0,4 - fuse inside [T 630 mA]
---------	--

MECHANIC PROPERTIES

Material:	Noryl GFN2 SE1, incombustible UL 94 V-I
Dimensions:	96 x 48 x 120 mm
Panel cut-out:	90,5 x 45 mm

* values apply for resistance load

OPERATING CONDITIONS

Connection:	connector terminal board, conductor cross-section $<1,5 \text{ mm}^2$ / $<2,5 \text{ mm}^2$
Stabilisation period:	within 15 minutes after switch-on
Working temp.:	-20°...60°C
Storage temp.:	-20°...85°C
Cover:	IP65 (front panel only)
Construction:	safety class I
Overvoltage cat.:	EN 61010-1, A2
Dielectric strength:	4 kVAC after 1 min between supply and input
	4 kVAC after 1 min between supply and data/ analog output
	4 kVAC after 1 min between supply and relay output
	2,5 kVAC after 1 min between input and data/ analog output
Insulation resist.:	for pollution degree II, measurement category III
	Instrument power supply > 670 V [PI], 300 V [DI]
	Input/output > 300 V [PI], 150 [DI]
EMC:	EN 61326-1

11. INSTRUMENT DIMENSIONS AND INSTALLATION



Front view

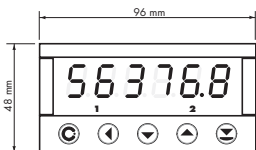

Panel cut

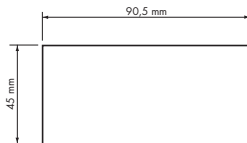

Side view

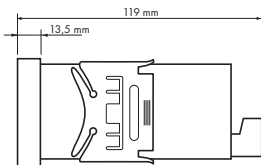

Panel thickness: 0,5...20 mm

INSTRUMENT INSTALLATION

1. insert the instrument into the panel cut-out
2. fit both travellers on the box
3. press the travellers close to the panel

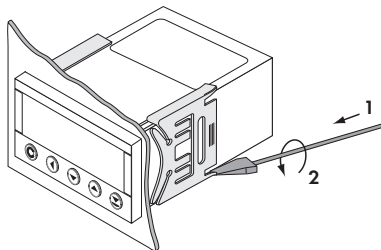
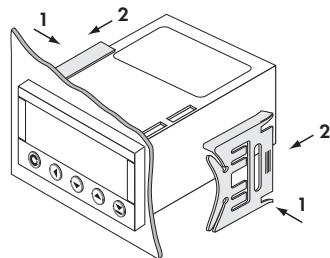

INSTRUMENT DISASSEMBLY

1. slide a screw driver under the traveller wing
2. turn the screw driver and remove the traveller
3. take the instrument out of the panel



Product **OM 653UQC**
Type
Manufacturing No.
Date of sale

A guarantee period of **60 months** from the date of sale to the user applies to this instrument.
Defects occurring during this period due to manufacture error or due to material faults shall be eliminated free of charge.

For quality, function and construction of the instrument the guarantee shall apply provided that the instrument was connected and used in compliance with the instructions for use.

The guarantee shall not apply to defects caused by:

- mechanic damage
- transportation
- intervention of unqualified person incl. the user
- unavoidable event
- other unprofessional interventions

The manufacturer performs guarantee and post.guarantee repairs unless provided for otherwise.



Stamp, signature



Company: **ORBIT MERRET, spol. s r.o.**
Klánova 81/141, 142 00 Prague 4, Czech Republic, IDNo: 00551309

Manufactured: **ORBIT MERRET, spol. s r.o.**
Vodňanská 675/30, 198 00 Prague 9, Czech Republic

declares at its explicit responsibility that the product presented hereunder meets all technical requirements, is safe for use when utilised under the terms and conditions determined by ORBIT MERRET, spol.s r.o. and that our company has taken all measures to ensure conformity of all products of the types referred-to hereunder, which are being brought out to the market, with technical documentation and requirements of the appurtenant Czech statutory orders.

Product: Programmable panel instrument

Type: **OM 653**

Version: UQC

It has been designed and manufactured in line with requirements of:

Statutory order no. 17/2003 Coll., on low-voltage electrical equipment [directive no. 73/23/EHS]
Statutory order no. 616/2006 Coll., on electromagnetic compatibility [directive no. 2004/108/EC]

The product qualities are in conformity with harmonized standard:

El. safety: EN 61010-1

EMC: EN 61326-1

Electronic measuring, control and laboratory devices – Requirements for EMC "Industrial use"

EN 50131-1, chap. 14 and chap. 16, EN 50130-4, chap. 7, EN 50130-4, chap. 8 [EN 61000-4-11, ed. 2], EN 50130-4, chap. 9 [EN 61000-4-2], EN 50130-4, chap. 10 [EN 61000-4-3, ed. 2], EN 50130-4, chap. 11, [EN 61000-4-6], EN 50130-4, chap. 12 [EN 61000-4-4, ed. 2], EN 50130-4, chap. 13 [EN 61000-4-5], EN 61000-4-8, EN 61000-4-9, EN 61000-6-1, EN 61000-6-2, EN 55022, chap. 5 and chap. 6

The product is furnished with CE label issued in 2010

As documentation serve the protocols of authorized and accredited organizations:

EMC MO ČR, Zkušebna tech. prostředků, protocol No.: 80/6-280/2007 of 13/11/2007
MO ČR, Zkušebna tech. prostředků, protocol No.: 80/6-283/2007 of 26/10/2007

Place and date of issue: Prague, 1. March 2010

Miroslav Hackl
Company representative

Assessment of conformity pursuant to §22 of Act no. 22/1997 Coll. and changes as amended by Act no.71/2000 Coll. and 205/2002 Coll