

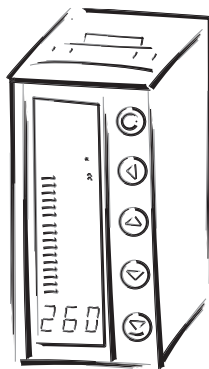

OMB 412UNI

3 DIGIT PROGRAMMABLE UNIVERSAL BARGRAPH

DC VOLTMETER/AMMETER
PROCESS MONITOR
OHMMETER
THERMOMETER FOR PT/NI/CU
THERMOMETER FOR THERMOCOUPLES
DISPLAYS FOR LIN. POTENTIOMETERS





SAFETY INSTRUCTIONS

Please, read the enclosed safety instructions carefully and observe them!
These instruments should be safeguarded by isolated or common fuses (breakers)
For safety information the EN 61 010-1 + A2 standard must be observed.
This instrument is not explosion-safe!

TECHNICAL DATA

Measuring instruments of the OMB 412 series conform to the European regulation 89/336/EWG.

The instruments are up to the following European standards:

EN 61010-1 Electrical safety

EN 61326-1 Electronic measuring, control and laboratory devices – Requirements for EMC "Industrial use"

Seismic capacity:

IEC 980: 1993, čl. 6

The instruments are applicable for unlimited use in agricultural and industrial areas.

CONNECTION

Supply of energy from the main line has to be isolated from the measuring leads.



ORBIT MERRET, spol. s r.o.

Vodnanská 675/30
198 00 Prague 9
Czech Republic

Tel: +420 - 281 040 200
Fax: +420 - 281 040 299
e-mail: orbit@merret.eu
www.orbit.merret.eu



1. CONTENTS	3
2. INSTRUMENT DESCRIPTION	4
3. INSTRUMENT CONNECTION	6
Measuring ranges	6
Termination of RS 485 communication line	6
Instrument connection	7
Recommended connection of sensors	8
4. INSTRUMENT SETTING	10
Symbols used in the instructions	12
Setting the DP and the {} sign	12
Control keys function	13
Setting/permitting items into 'USER' menu	13
5. SETTING "LIGHT" MENU	14
5.0 Description "LIGHT" menu	14
Setting input - Type "DC"	18
Setting input - Type "PM"	20
Setting input - Type "OHM"	22
Setting input - Type "RTD - Pt"	24
Setting input - Type "RTD - Ni"	26
Setting input - Type "T/C"	28
Setting input - Type "DU"	30
Setting input - Type "RTD - Cu"	32
Setting Limits	34
Setting analog output	36
Selection of bargraph projection	38
Selection of programming menu „LIGHT"/„PROFI"	40
Restoration of manufacture setting	40
Calibration - input range (DU)	41
Selection of instrument menu language version	42
Setting new access password	42
Instrument identification	43
6. SETTING "PROFI" MENU	44
6.0 Description of "PROFI" menu	44
6.1 "PROFI" menu - INPUT	48
6.1.1 Resetting internal values	48
6.1.2 Setting measuring type, range, mode, rate	49
6.1.3 Setting the Real Time	53
6.1.4 External input function selection	53
6.1.5 Optional accessory functions of the keys	54
6.2 "PROFI" menu - CHANNEL	58
6.2.1 Setting measuring parameters (projection, filters, decimal point, description)	58
6.2.2 Setting mathematic functions	61
6.2.3 Selection of evaluation of min/max. value	63
6.3 "PROFI" menu - OUTPUT	64
6.3.1 Setting data logging	64
6.3.2 Setting Limits	66
6.3.3 Setting data output	59
6.3.4 Setting analog output	70
6.3.5 Selection of display projection	72
6.3.5 Selection of bargraph projection	73
6.4 "PROFI" menu - SERVICE	78
6.4.1 Selection of programming menu „LIGHT"/„PROFI"	78
6.4.2 Restoration manufacture setting	79
6.4.3 Calibration - input range (DU)	80
6.4.4 Selection of instrument menu language version	80
6.4.5 Setting new access password	80
6.4.6 Instrument identification	81
7. SETTING ITEMS INTO "USER" MENU	82
8. METHOD OF MEASURING OF THE COLD JUNCTION	84
9. ERROR STATEMENTS	85
10. DATA PROTOCOL	86
11. TECHNICAL DATA	88
12. INSTRUMENT DIMENSIONS AND INSTALATION	90
13. CERTIFICATE OF GUARANTEE	91

2. INSTRUMENT DESCRIPTION



2.1 DESCRIPTION

The OMB 412 model series are 24 LED, 3-colour panel programmable horizontal bargraph designed for maximum efficiency and user comfort while maintaining their favourable price. Two models are available: UNI and PWR.

Type OMB 402UNI is a multifunction instrument with the option of configuration for 8 various input options, easily configurable in the instrument menu. By further options of input modules it is feasible to measure larger ranges of DC voltage and current or increase the number of inputs up to 4 (applies for PM).

The instrument is based on an 8-bit microcontroller with a multichannel 24-bit sigma-delta converter, which secures high accuracy, stability and easy operation of the instrument.

TYPES AND RANGES

UNI	DC: 0...60/150/300/1200 mV
	PM: 0...5/20 mA/4...20 mA; $\pm 2/\pm 5/\pm 10/\pm 40$ V
	OHM: 0...100 Ω /0...1/10/100 k Ω
	RTD-Pt: Pt 50/100/500/1000
	RTD-Cu: Cu 50/100
	RTD-Ni: Ni 1 000/10 000
	T/C: J/K/T/E/B/S/R/N/L
	DU: Linear potentiometer (min. 500 Ω)
UNI - A	DC: $\pm 0.1/\pm 0.25/\pm 0.5/\pm 2/\pm 5$; $\pm 100/\pm 250/\pm 500$ V
UNI - B	PM: 3x 0...5/20 mA/4...20 mA; $\pm 2/\pm 5/\pm 10/\pm 40$ V

PROGRAMMABLE PROJECTION

Selection:	of type of input and measuring range
Measuring range:	adjustable as fixed or with automatic change
Setting:	manual, optional projection on the display may be set in the menu for both limit values of the input signal, e.g. input 0...20 mA > 0...850
Projection:	24-segment LED 3-color bargraph + 3-digit display -99...999

COMPENSATION

of conduct:	in the menu it is possible to perform compensation for 2-wire connection
of conduct in probe:	internal connection (conduct resistance in measuring head)
of CJC (T/C):	manual or automatic, in the menu it is possible to perform selection of the type of thermocouple and compensation of cold junctions, which is adjustable or automatic (temperature at the brackets)

LINEARIZATION

Linearization:*	by linear interpolation in 50 points (solely via DM Link)
-----------------	---

DIGITAL FILTERS

Floating average:	from 2...30 measurements
Exponen. average:	from 2...100 measurements
Arithmetic average:	from 2...100 measurements
Rounding:	setting the projection step for display

MATHEMATIC FUCTIONS

Min/max. value:	registration of min./max. value reached during measurement
Tare:	designed to reset display upon non-zero input signal
Peak value:	the display shows only max. or min. value
Mat. operations:	polynome, $1/x$, logarithm, exponential, power, root, sin x

* only for types DC, PM, DU

EXTERNAL CONTROL

Lock:	control keys blocking
Hold:	display/instrument blocking
Tare:	tare activation/resetting tare to zero
Resetting MM:	resetting min/max value
Memory:	data storage into instrument memory

2.2 OPERATION

The instrument is set and controlled by five control keys located on the front panel. All programmable settings of the instrument are performed in three adjusting modes:

LIGHT	Simple programming menu - contains solely items necessary for instrument setting and is protected by optional number code
PROFI	Complete programming menu - contains complete instrument menu and is protected by optional number code
USER	User programming menu - may contain arbitrary items selected from the programming menu (LIGHT/PROFI), which determine the right (see or change) - access without password

All programmable parameters are stored in the EEPROM memory (they hold even after the instrument is switched off).



Complete instrument operation and setting may be performed via OM Link communication interface, which is a standard equipment of all instruments.

The operation program is freely accessible [www.orbit.merret.eu] and the only requirement is the purchase of OML cable to connect the instrument to PC. It is manufactured in version RS 232 and USB and is compatible with all DRBIT MERRET instruments. Another option for connection is with the aid of data output RS 232 or RS 485 (without the need of the OML cable).

The program OM LINK in „Basic“ version will enable you to connect one instrument with the option of visualization and archiving in PC. The OM Link „Standard“ version has no limitation of the number of instruments connected.

2.3 OPTIONS

Excitation is suitable for supplying power to sensors and transmitters. It has a galvanic separation.

Comparators are assigned to monitor one, two, three or four limit values with relay output. The user may select limits regime: LIMIT/DOSING/FROM-TO. The limits have adjustable hysteresis within the full range of the display as well as selectable delay of the switch-on in the range of 0...99,9 s. Reaching the preset limits is signalled by LED and simultaneously by the switch-on of the relevant relay.

Data outputs are for their rate and accuracy suitable for transmission of the measured data for further projection or directly into the control systems. We offer an isolated RS232 and RS485 with the ASCII or DIN MessBus protocol.

Analog outputs will find their place in applications where further evaluating or processing of measured data is required in external devices. We offer universal analog output with the option of selection of the type of output - voltage/current. The value of analog output corresponds with the displayed data and its type and range are selectable in Menu.

Measured data record is an internal time control of data collection. It is suitable where it is necessary to register measured values. Two modes may be used. FAST is designed for fast storage (40 records/s) of all measured values up to 8 000 records. Second mode is RTC, where data record is governed by Real Time with data storage in a selected time segment and cycle. Up to 250 000 values may be stored in the instrument memory. Data transmission into PC via serial interface RS232/485 and OM Link.

3. INSTRUMENT CONECTION



The instrument supply leads should not be in proximity of the incoming low-potential signals.

Contactors, motors with larger input power should not be in proximity of the instrument.

The leads into the instrument input (measured quantity) should be in sufficient distance from all power leads and appliances. Provided this cannot be secured it is necessary to use shielded leads with connection to ground (bracket E).

The instruments are tested in compliance with standards for use in industrial area, yet we recommend to abide by the above mentioned principles.

MEASURING RANGES

TYPE	INPUT I	INPUT U
DC		0...60/150/300/1 200 mV
PM	0...5/20 mA/4...20 mA	±2/±5/±10/±40 V
DHM	0...100 Ω/0...1/10/100 kΩ	
RTD-Pt	Pt 50/100/500/1 000	
RTD-Cu	Cu 50/100	
RTD-Ni	Ni 1 000/10 000	
T/C	J/K/T/E/B/S/R/N/L	
DU	Linear potentiometer (min. 500 Ω)	

OPTION "A"

TYPE	INPUT I	INPUT U
DC	±0,1/±0,25/±0,5 A to GND [C] ±2/±5 A to GND [B]	±100/±250/±500 V to GND [C]

OPTION "B"

TYPE	INPUT 2, 3, 4/I	INPUT 2, 3, 4/U
PM	0...5/20 mA/4...20 mA	±2/±5/±10/±40 V

Termination of RS 485 communication line

X3 - Termination of communication line RS 485

Full	Significance	Default	Recomendation
1-2	connect L+ to (+) source	terminalconnected	connect at the end of line do not disconnect
3-4	termination of line 120 Ohm	disconnected	
5-6	connect L- to (-) source	terminalconnected	

RS 485 line should have a linear structure - wires (ideally shielded and twisted) should lead from one device to another.

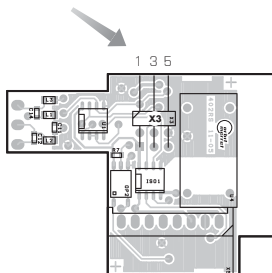

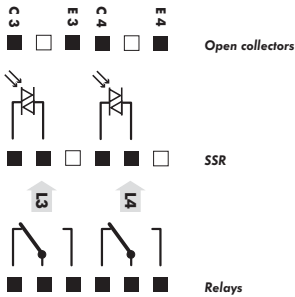

!
Excitation has the minus pole common with the input - the bracket no. 20 - GND and you may set its value by trimmer above the bracket no. 17

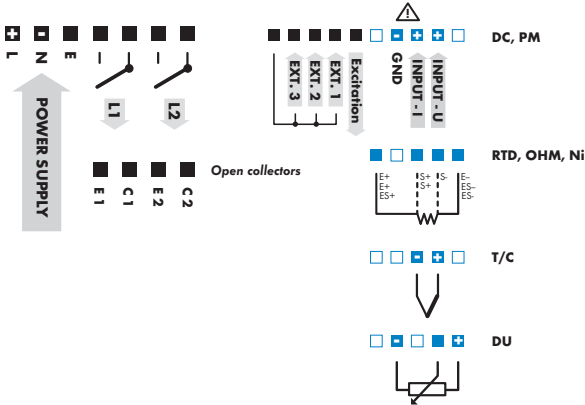
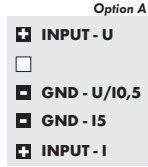
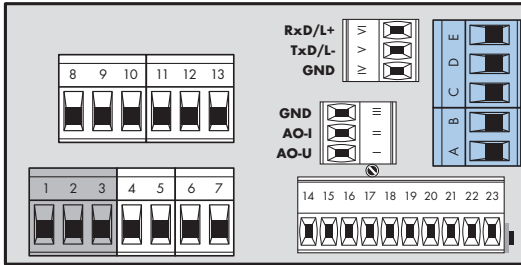

Maximum of 250 mA may be connected to "INPUT - I" (bracket no. 21), i.e. 10-times range overload. Mind the correct connection/mistaking of current - voltage input. Destruction of measuring resistance in current input (15R) may occur.

3. INSTRUMENT CONNECTION

Example connection of a 2-wire sensor with current signal output powered by instrument's excitation

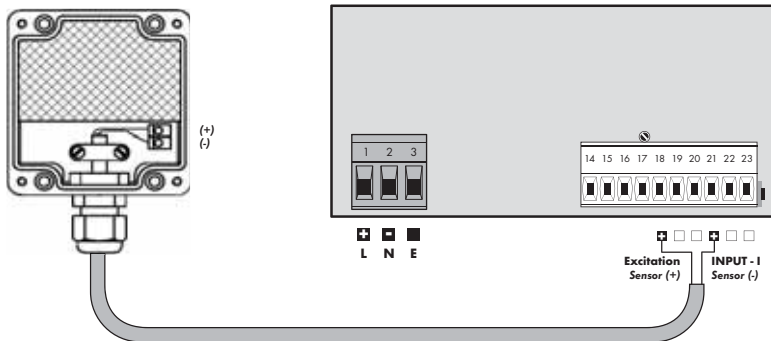

Example connection of a 3-wire sensor with current signal output powered by instrument's excitation

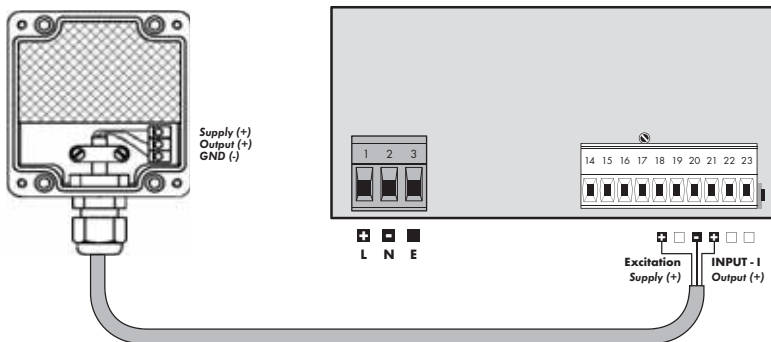

Example connection of 3-wire sensor with voltage signal output powered by instrument's excitation

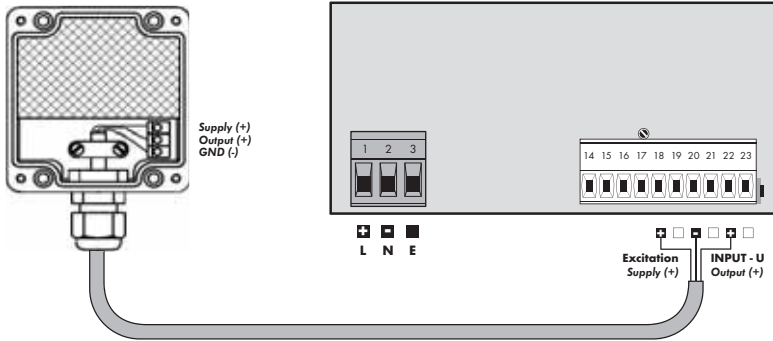

Example connection of resistance measurement using 4 wires

By connecting resistor R^* we eliminate error message E. I.Ov. (input overflow) when the measured resistance is disconnected

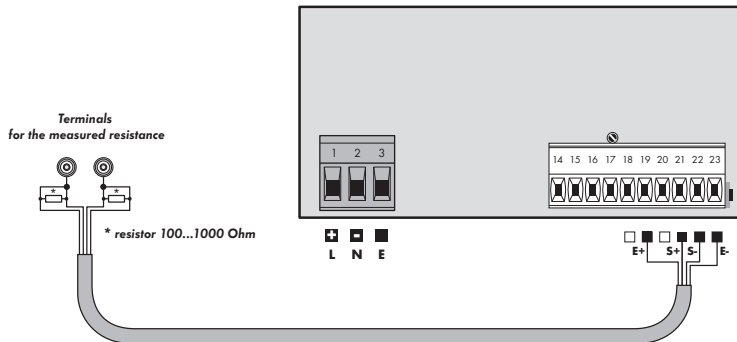



SETTING **PROFI**

For expert users

Complete instrument menu

Access is password protected

Possibility to arrange items of the **USER MENU**

Tree menu structure

SETTING **LIGHT**

For trained users

Only items necessary for instrument setting

Access is password protected

Possibility to arrange items of the **USER MENU**

Linear menu structure

SETTING **USER**

For user operation

Menu items are set by the user (Profi/Light) as per request

Access is not password protected

Optional menu structure either tree (PROFI) or linear (LIGHT)

4.1 SETTING

The instrument is set and controlled by five control keys located on the front panel. All programmable settings of the instrument are performed in three adjusting modes:

- LIGHT** **Simple programming menu**
 - contains solely items necessary for instrument setting and is protected by optional number code
- PROFI** **Complete programming menu**
 - contains complete instrument menu and is protected by optional number code
- USER** **User programming menu**
 - may contain arbitrary items selected from the programming menu (LIGHT/PROFI), which determine the right (see or change)
 - access without password

All programmable parameters are stored in the EEPROM memory (they hold even after the instrument is switched off).

Complete instrument operation and setting may be performed via QM Link communication interface, which is a standard equipment of all instruments.

The operation program is freely accessible (www.orbit.merret.eu) and the only requirement is the purchase of QML cable to connect the instrument to PC. It is manufactured in version RS 232 and USB and is compatible with all ORBIT MERRET instruments. Another option for connection is with the aid of data output RS 232 or RS 485 (without the need of the QML cable).

Scheme of processing the measured signal

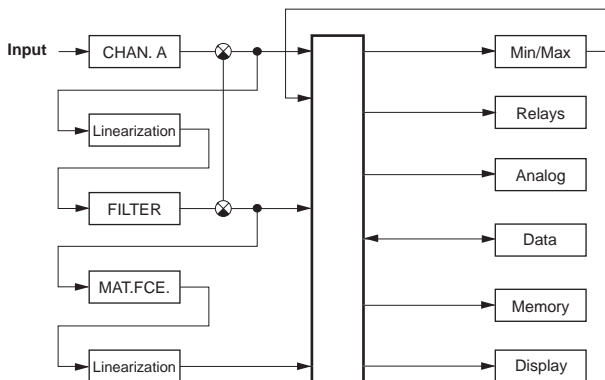

4. INSTRUMENT SETTING

Setting and controlling the instrument is performed by means of 5 control keys located on the front panel. With the aid of these keys it is possible to browse through the operation menu and to select and set required values.

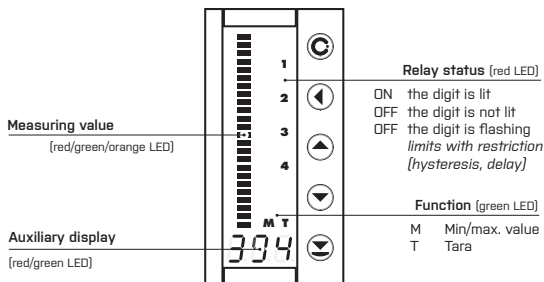

Symbols used in the instructions

DC **PM**
DU **OHM** **RTD** **T/C** Indicates the setting for given type of instrument

DEF values preset from manufacture

symbol indicates a flashing light (symbol)

MIN inverted triangle indicates the item that can be placed in USER menu

CON broken line indicates a dynamic item, i.e. it is displayed only in particular selection/version

after pressing the key the set value will not be stored

after pressing the key the set value will be stored

30 continues on page 30

Setting the decimal point and the minus sign

DECIMAL POINT

Its selection in the menu, upon modification of the number to be adjusted it is performed by the control key **1** with transition beyond the highest decade, when the decimal point starts flashing . Positioning is performed by **2** **3**

THE MINUS SIGN

Setting the minus sign is performed by the key **4** on higher decade. When editing the item subtraction must be made from the current number [e.g.: 013 > **4** , on class 100 > -87]

Control keys functions

KEY	MEASUREMENT	MENU	SETTING NUMBERS/SELECTION
	access into USER menu	exit menu	quit editing
	programmable key function	back to previous level	move to higher decade
	programmable key function	move to previous item	move down
	programmable key function	move to next item	move up
	programmable key function	confirm selection	confirm setting/selection
			numeric value is set to zero
	access into LIGHT/PROFI menu		
	direct access into PROFI menu		
		configuration of an item for "USER" menu	
		determine the sequence of items in "USER - LIGHT" menu	

Setting items into „USER" menu

- in **LIGHT** or **PROFI** menu
- no items permitted in **USER** menu from manufacture
- on items marked by inverted triangle

USER

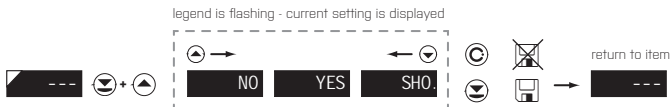

NO	item will not be displayed in USER menu
YES	item will be displayed in USER menu with the option of setting
SHO.	item will be solely displayed in USER menu



SETTING **LIGHT**

For trained users

Only items necessary for instrument setting

Access is password protected

Possibility to arrange items of the **USER MENU**

Linear menu structure

Access password
 1428 **PAS.**

Type of instruments **TYP.** **PM** Measuring range **MOD.**

RTD **OHM**
CON. **2-W** **FOR.**

V/C
CON. **EX1** **T.C.J.** **FOR.**

DC **PM** **OHM** **DU**
MIN **MAX** **FOR.**

L1 **L2** **L3** **L4**

Option - comparator

A.T. **ALo.** **AHi.**

Option - Analog output

Setting bargraph projection - MIN **BLo.** Setting bargraph projection - MAX **BHi.** Setting bargraph colors **COL.** **GRE.**

Menu type **MNU.** **LI G.** Return to manufacture calibration **CAL.** Return to manufacture setting **SET.**

DU Calibration - only for "DU"
CLo. **CHi.**

Language selection **LAN.** **ENG.** New password **PLI.**

Identification **ID.** Type of instruments **OMB 412UNI** SW. version **78-001** Input **PM** Return to measuring mode

Preset from manufacture

Password	"0"
Menu	LIGHT
USER menu	off
Setting the items	DEF



Upon delay exceeding 60 s the programming mode is automatically discontinued and the instrument itself restores the measuring mode

5. SETTING LIGHT

142



PAS.

0

Entering access password for access into the menu

PAS. Access into instrument menu

PAS. = 0

- access into menu is unrestricted, after releasing keys you automatically move to first item of the menu

PAS. > 0

- access into menu is protected by number code

Set "Password" = 42 Example

0 1 2 02 12 22

32 42 TYP

TYP.

DC PM OHM Pt Ni TC

DU Cu

TYP. Selection of the type of instrument

- primary selection of the type of instrument
- performs default setting **DEF** of values from manufacture, incl. calibration
- **DEF** = „PM“

Menu	Type of instrument
DC	DC voltmeter
PM	Process monitor
OHM	Ohmmeter
Pt	Thermometer for sensors Pt
Ni	Thermometer for sensors Ni
TC	Thermometer for thermocouples
DU	Display for lin. potentiometer
Cu	Thermometer for sensors Cu

Type "PM" Example

DC PM MOD

Type „DC“	18
Type "PM"	20
Type "OHM"	22
Type "RTD-Pt"	24
Type "RTD-Ni"	26
Type "T/C"	28
Type "DU"	30
Type "RTD-Cu"	32



5. SETTING PROFI

MEASURING MODE > DC

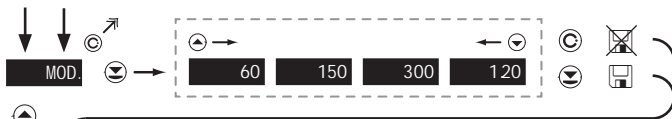

MOD Selection of the instrument measuring range

DEF = 60 mV

DEF = 500 V*

* only for option "A"

Menu	Measuring range
60	±60 mV
150	±150 mV
300	±300 mV
1.20	±1.2 V
100	±100 V
250	±250 V
500	±500 V
0.10	±0.1 A
0.25	±0.25 A
0.50	±0.5 A
1.00	±1 A
5.00	±5 A

Range ±150 mV Example

60 150 M N



MIN Setting display projection for minimum value of input signal

- range of the setting: -99...999
- position of the DP does not affect display projection

- the DP is automatically shifted after the value is confirmed

DEF = 0

Projection for 0 mV > MIN = 0 Example

MAX



MAX Setting display projection for maximum value of input signal

- range of the setting: -99...999
- position of the DP does not affect display projection

- the DP is automatically shifted after the value is confirmed

DEF = 100

Projection for 150 mV > MAX = 350 Example

100	100	110	120	130	140
150	150	250	350	FOR	

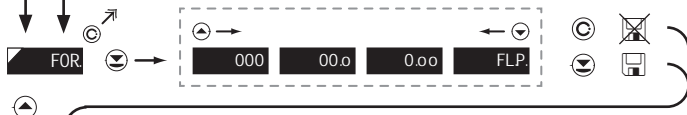

FOR Setting projection of the decimal point

- positioning of the DP is set here in the measuring mode

DEF = 000

Projection of DP on display > 00.0 Example

000	00.0	8Lo
-----	------	-----

*subsequent item on the menu depends on instrument equipment

5. SETTING LIGHT

MEASURING MODE > PM

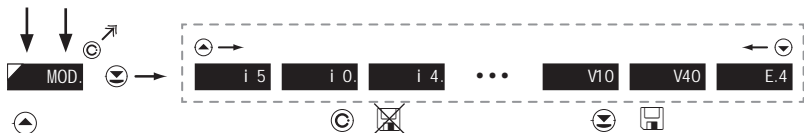

MOD. Selection of the instrument measuring range

DEF = 4 - 20 mA

Menu	Measuring range
i 5	0...5 mA
i 0	0...20 mA
i 4	4...20 mA
u 2	±2 V
u 5	±5 V
u 10	±10 V
u 40	±40 V
E. 4	4...20 mA, with error statement of „underfl ow“ upon signal smaller than 3,36 mA

Range 0...20 mA Example

i 4 i 0 MIN



MIN Setting display projection for minimum value of input signal

- range of the setting: -99...999
- position of the DP does not affect display projection

- the DP is automatically shifted after the value is confirmed

DEF = 0

Projection for 0 mA > MIN = -25 Example

0	1	2	3	4	5	MAX
05	5	05	15	25		



MAX Setting display projection for maximum value of input signal

- the DP is automatically shifted after the value is confirmed

- range of the setting: -99...999
- position of the DP does not affect display projection

DEF = 100

Projection for 20 mA > MAX = 250 Example

100	100	110	120	130	140
150	150	250	FOR		



FOR Setting projection of the decimal point

- positioning of the DP is set here in the measuring mode

DEF = 000

Projection of DP on display > 00.0 Example

000	00.0	B.L0
-----	------	------

*subsequent item on the menu depends on instrument equipment

5. SETTING LIGHT

MEASURING MODE > OHM

The diagram illustrates the navigation path through the instrument's menu system. It starts with the 'MOD.' menu, then moves to 'CON.', and finally to 'MIN'. Each menu screen includes a 'DEF' (default) value and an 'Example' row showing the current settings.

MOD. Selection of instrument measuring range

DEF = 100 Ω

Menu	Measuring range
01	0...100 Ω
1.0	0...1 kΩ
10.0	0...10 kΩ
100	0...100 kΩ

Range 0...10 kΩ Example

01 1.0 10.0 CON.

CON. Selection of the type of sensor connection

DEF = 2-wire

Menu	Connection
2-W	2-wire
3-W	3-wire
4-W	4-wire

Type of connection - 3 wire > CON. = 3-W Example

2-W 3-W MN

MIN Setting display projection for minimum value of input signal

Setting for minimum input signal

0

DEF = 0

Projection for 0 Ohm > MIN = 0 Example

0 MAX



MAX Setting display projection for maximum value of input signal

signal

- range of the setting: -99...999
- position of the DP does not affect display projection

- the DP is automatically shifted after the value is confirmed

DEF = 100

Projection for 10 kOhm > MAX = 300 Example

100 100 100 200 300 For



FOR Setting projection of the decimal point

positioning of the DP is set here in the measuring mode

DEF = 000

Projection of DP on display > 00.0 Example

000 00.0 BLo

*subsequent item on the menu depends on instrument equipment

5. SETTING LIGHT

MEASURING MODE > RTD - Pt

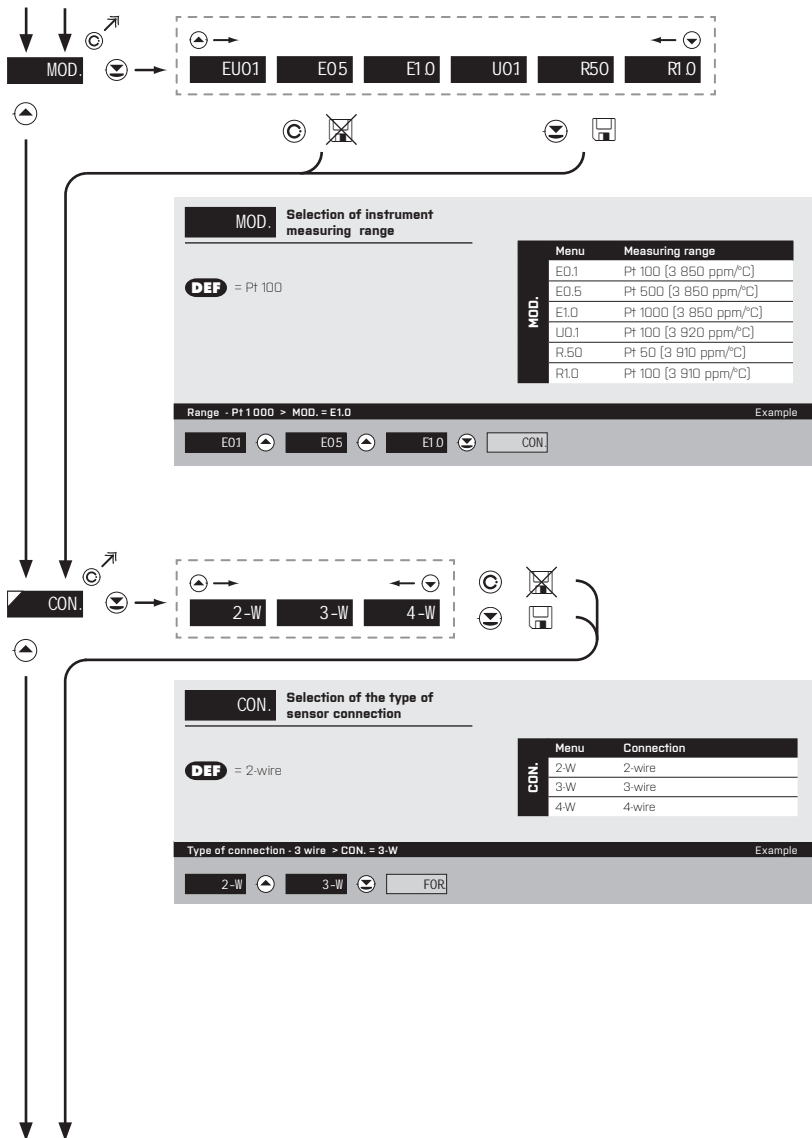

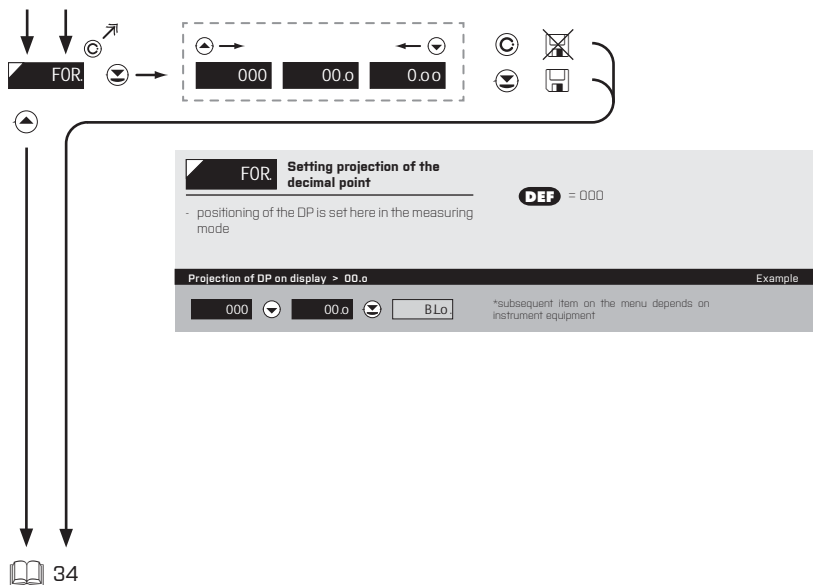

5. SETTING LIGHT

MEASURING MODE > RTD - Ni

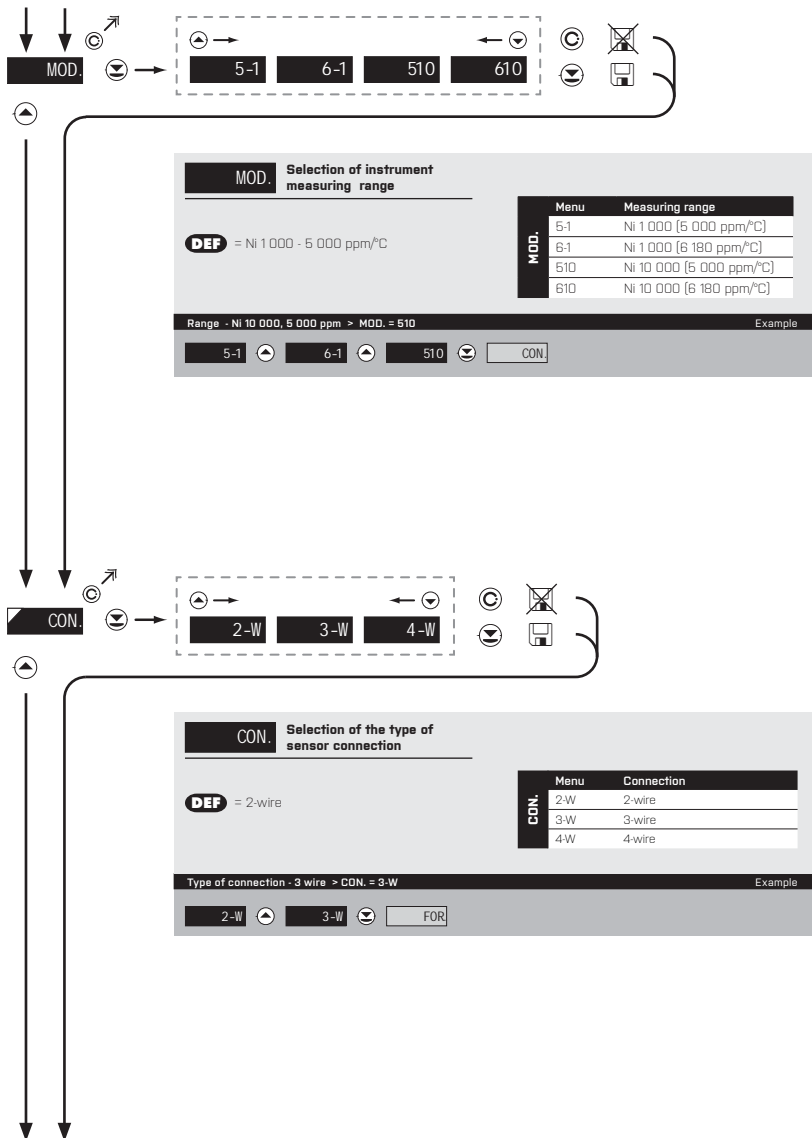

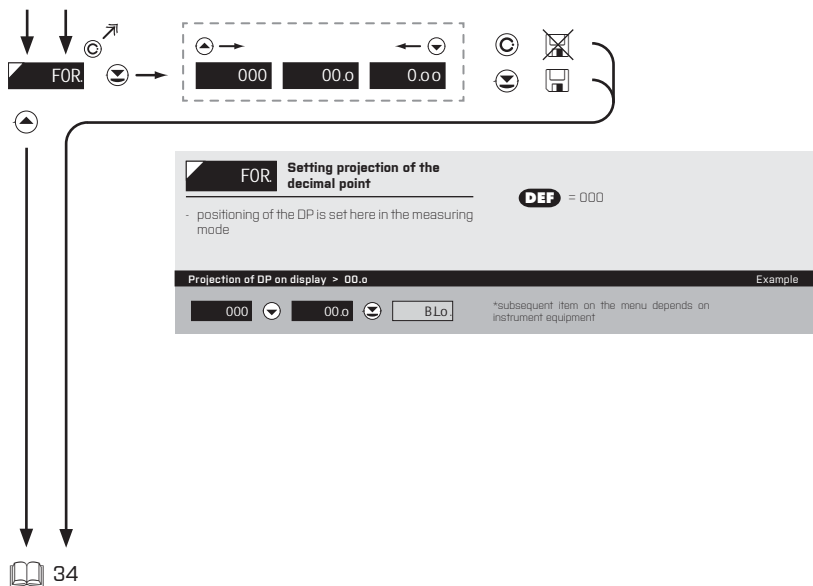

6. SETTING PROFI

MEASURING MODE > T/C

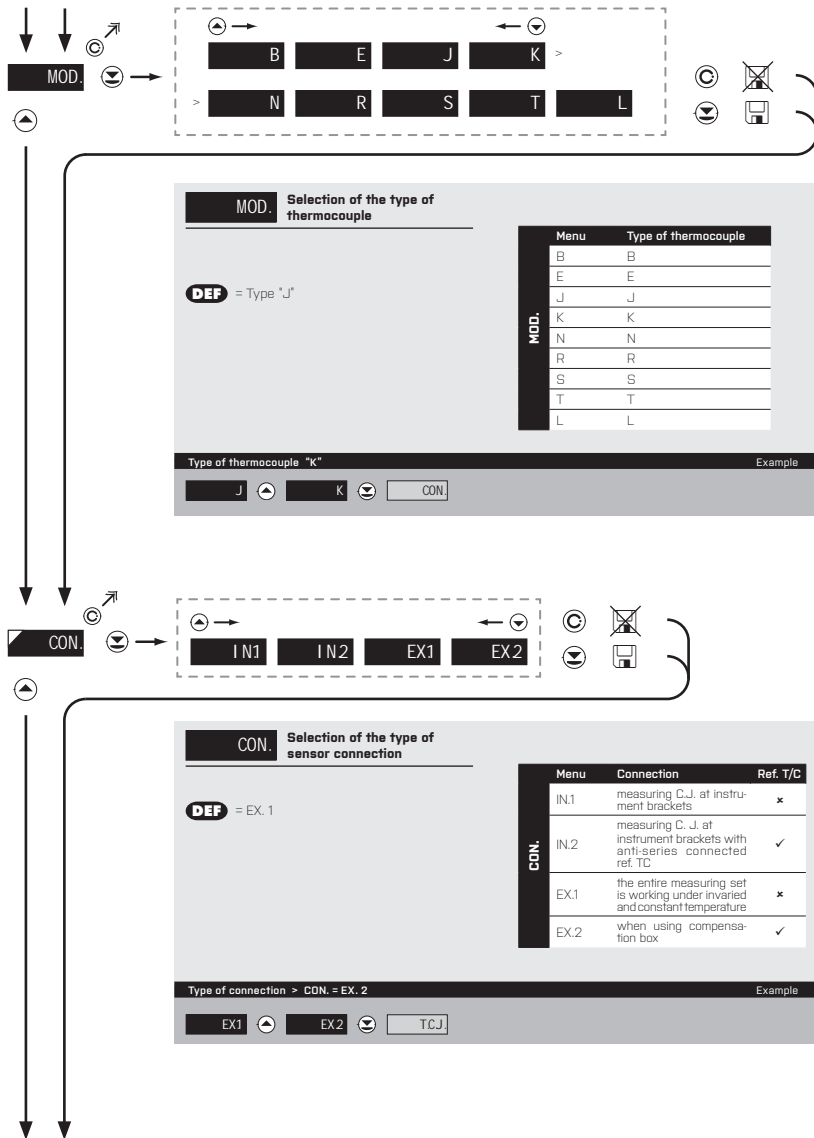

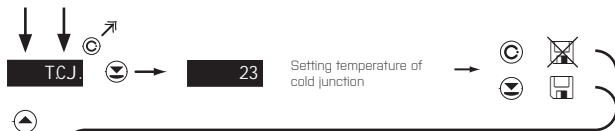

Setting temperature of cold junction

23

T.C.J. Setting temperature of cold junction

DEF = 23

- range 0...99°C with compensation box

Setting temperature of cold junction > T.C.J. = 35 Example

23 24 25 25 35 FOR

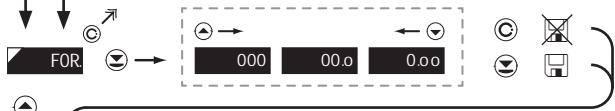

FOR Setting projection of the decimal point

DEF = 000

- positioning of the DP is set here in the measuring mode

Projection of DP on display > 00.0 Example

000

00.0

B.L0

*subsequent item on the menu depends on instrument equipment

! For thermocouple type "B" the items CON. and T.C.J. are not available

! Method and procedure of setting the cold junctions is described in separate chapter on page 84

5. SETTING LIGHT

MEASURING MODE > DU



MIN **Setting display projection for minimum value of input signal**

- range of the setting: -99...999
- position of the DP does not affect display projection

- the DP is automatically shifted after the value is confirmed

DEF = 0

Projection for the beginning > MIN = 0 Example

0 [DP] MAX



MAX **Setting display projection for maximum value of input signal**

- range of the setting: -99...999
- position of the DP does not affect display projection

- the DP is automatically shifted after the value is confirmed

DEF = 100

Projection for the end > MAX = 500 Example

100 [DP] 100 [DP] 100 [DP] 200 [DP] 300 [DP] 400 [DP]

500 [DP] FOR

FOR

000 00.0 0.00 FLP.

FOR **Setting projection of the decimal point** **DEF** = 000

- positioning of the DP is set here in the measuring mode

Projection of DP on display > 000 Example

000 **BL0** *subsequent item on the menu depends on instrument equipment

34 Calibration of the beginning and the end of range of linear potentiometer is on page 41

5. SETTING LIGHT

MEASURING MODE > RTD - Cu

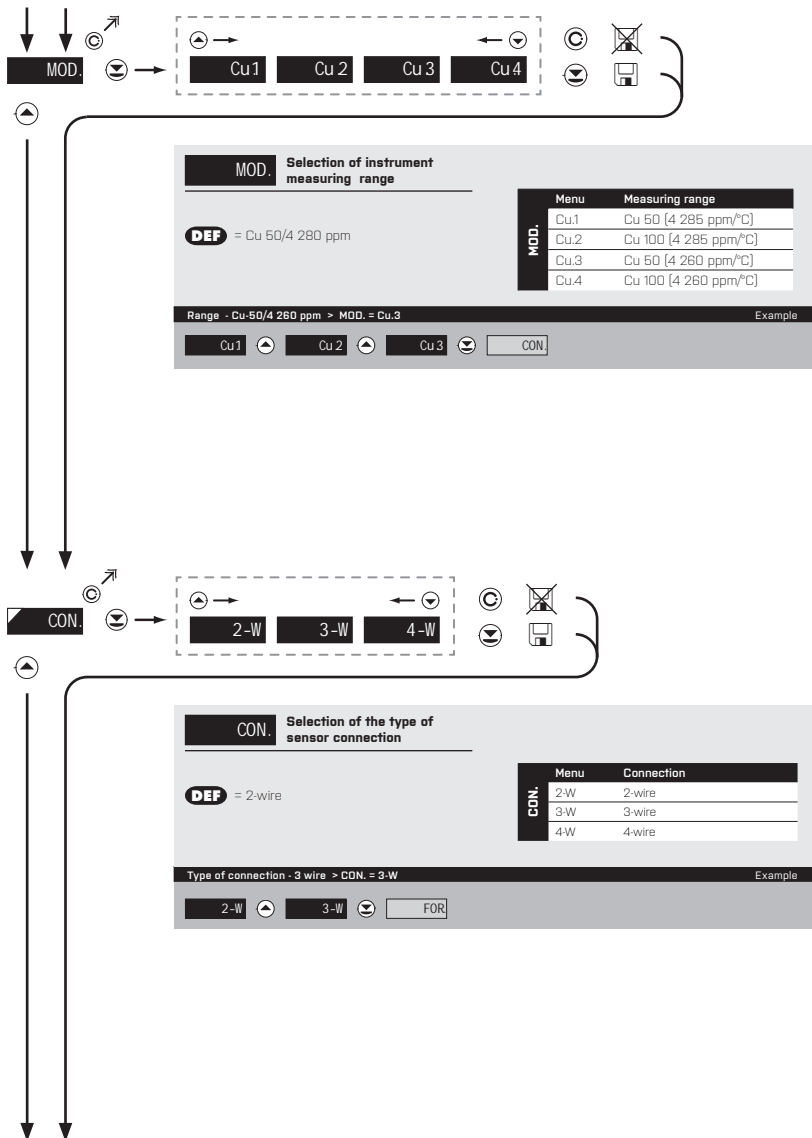

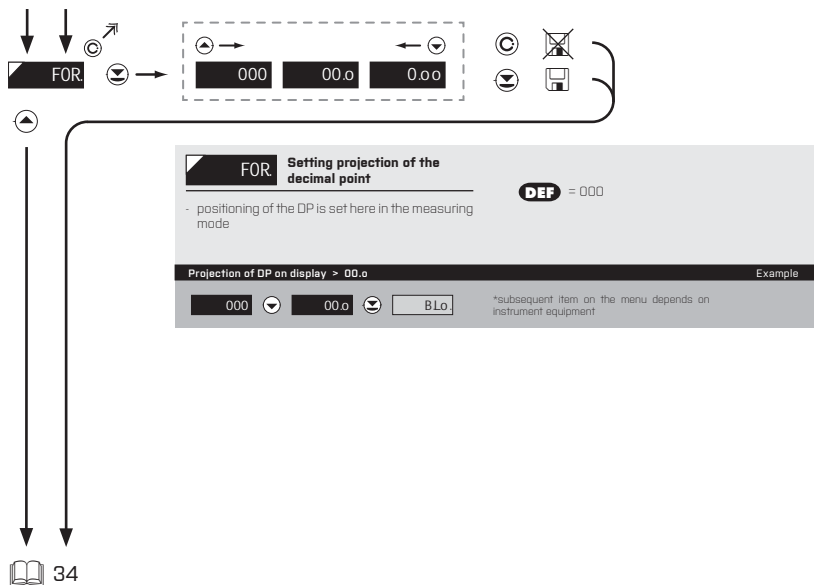

5. SETTING LIGHT

DISPLAYED ONLY WITH OPTIONS > COMPARATORS

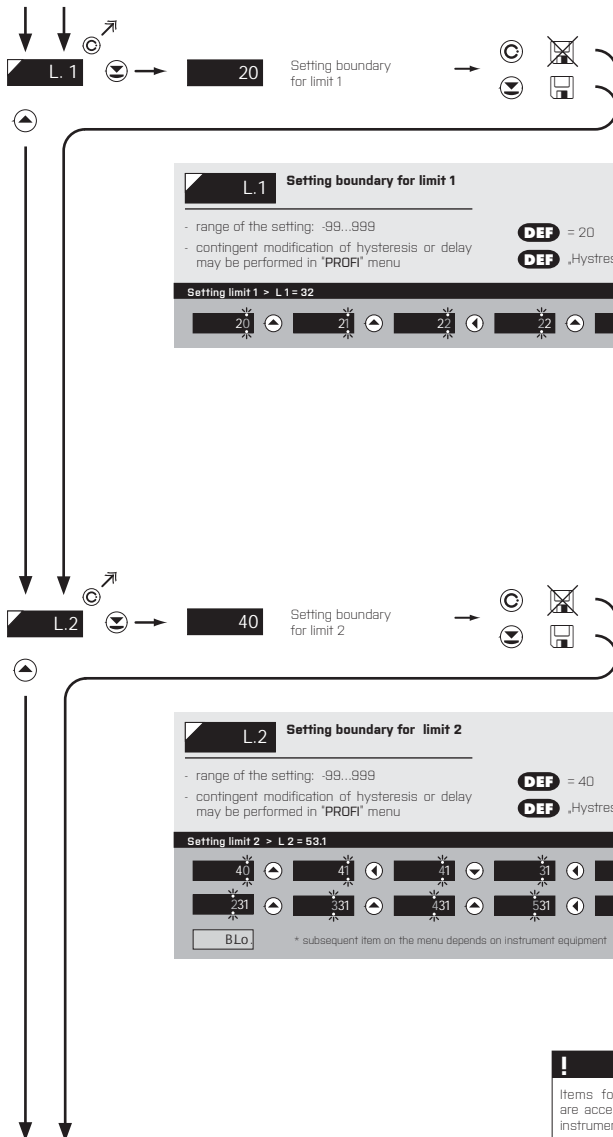

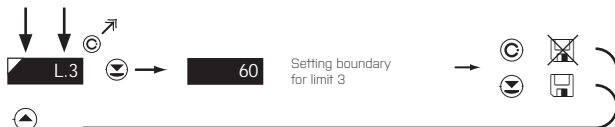

L.3

Setting boundary for limit 3

- range of the setting: -99...999
- contingent modification of hysteresis or delay may be performed in 'PROF' menu

DEF = 60

DEF „Hysteresis“=0, „Delay“=0

Setting limit 3 > L.3 = 85 Example

60	61	62	63	64	65
65	75	95	BLo	* subsequent item on the menu depends on instrument equipment	



L.4

Setting boundary for limit 4

- range of the setting: -99...999
- contingent modification of hysteresis or delay may be performed in 'PROF' menu

DEF = 80

DEF „Hysteresis“=0, „Delay“=0

Setting limit 4 > L.4 = 103 Example

80	81	82	83	93
03	003	103	BLo	* subsequent item on the menu depends on instrument equipment

5. SETTING LIGHT

DISPLAYED ONLY WITH OPTIONS > ANALOG OUTPUT

The diagram illustrates the navigation path for setting the analog output type and the display value for the beginning of the AD range. It shows the A.T. menu, the ALo menu, and the resulting settings for the display value.

A.T. Setting the type of analog output

Menu	Range	Description
i 0	0...20 mA	
E 4	4...20 mA	with error message indication and broken loop indication (<3,6 mA)
i4T	4...20 mA	with broken loop indication (<3,6 mA)
E 4	4...20 mA	with indication of error statement (<3,6 mA)
i 4	4...20 mA	
i 5	0...5 mA	
u 2	0...2 V	
u 5	0...5 V	
u10	0...10 V	
-10	±10 V	

DEF = 4...20 mA

Type of analog output - 0...10 V > A. t. = u 10

ALo. Assigning the display value to the beginning of the AD range

DEF = 0

range

- range of the setting: -99...999

Display value for the beginning of the AD range > A.Lo = 0

! Items for "Limits" and "Analog output" are accessible only if incorporated in the instrument.



A.Hi. Assigning the display value to the end of the AD range

- range of the setting: -99...999 **DEF** = 100

Display value for the end of the AD range > A.Hi. = 120 Example

100 ◀ 100 ▶ 110 ▶ 120 ☺ B.L.o.

5. SETTING LIGHT

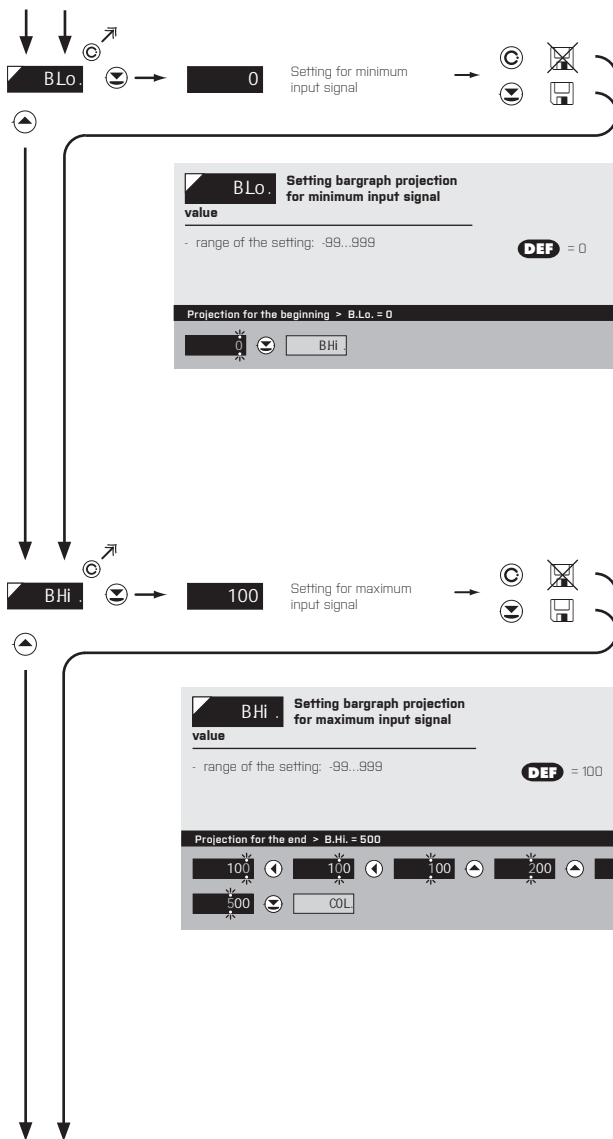



COL. **Select bargraph color**

DEF = Green

- the color for bargraph in basic mode "Column" is set here
- for other bargraph working modes it is necessary to switch to the "PROFI" menu

Selection of bargraph color > Orange Example

GRE **ORA**

5. SETTING LIGHT

The diagram illustrates the menu navigation process for setting the instrument type. It starts at the **MNU** screen, which can be navigated to **LIG.** or **PROFI**. From **LIG.**, the user can go to **CAL.** or **SET.**. From **CAL.**, the user can go to **YES**. From **SET.**, the user can go to **TYP.** or **USR.**. A table of instrument types is provided at the bottom left.

MNU. Setting the menu type LIGHT/PROFI

LIG. > menu LIGHT, a simple menu, which contains only the most essential items necessary for instrument setting
> linear tree structure

PRO. > menu PROFi, a complete menu for complete instrument setting
> tree menu structure

DEF = LIGHT

Menu LIGHT > MNU. = LIG. Example

LIG. CAL

CAL. Restoration of manufacture calibration

- in the event of error calibration it is feasible to restore manufacture calibration
- Prior to execution of any modifications you will be asked to confirm your selection (YES)

Restoration of manufacture calibration > CAL. Example

CAL. YES SET

SET. Restoration of manufacture instrument setting

- in the event of error setting the manufacture setting may be restored
- restoration is performed for the currently selected type of the instrument input (select 'TYP.')
- provided you stored your user setting in the 'PROFI' menu, it may also be restored (select 'USR.')
- loading manufacture calibration and primary setting of items on the menu (DEF)

Restoration of manufacture setting > SET. Example

SET. TYP. LAN

* subsequent item on the menu depends on instrument equipment

Type „DC“	42
Type „PM“	42
Type „OHM“	42
Type „Pi“	42
Type „Ni“	42
Type „T/C“	42
Type „DU“	41
Type „Cu“	42

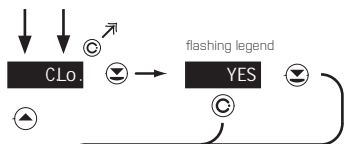

C.Lo. Calibration of input range - the potentiometer traveller in initial position Only for type "DU"

- prior confirming the flashing "YES" sign the potentiometer traveller has to be in given idle position

Calibration of the beginning of the range > C.Lo. Example

YES CHI

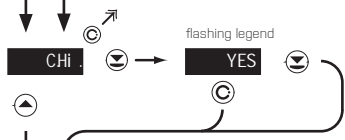

CHI Calibration of input range - the potentiometer traveller in end position Only for type "DU"

- prior confirming the flashing "YES" sign the potentiometer traveller has to be in given idle position

Calibration of the end of the range > C.Hi. Example

YES LAN

5. SETTING LIGHT

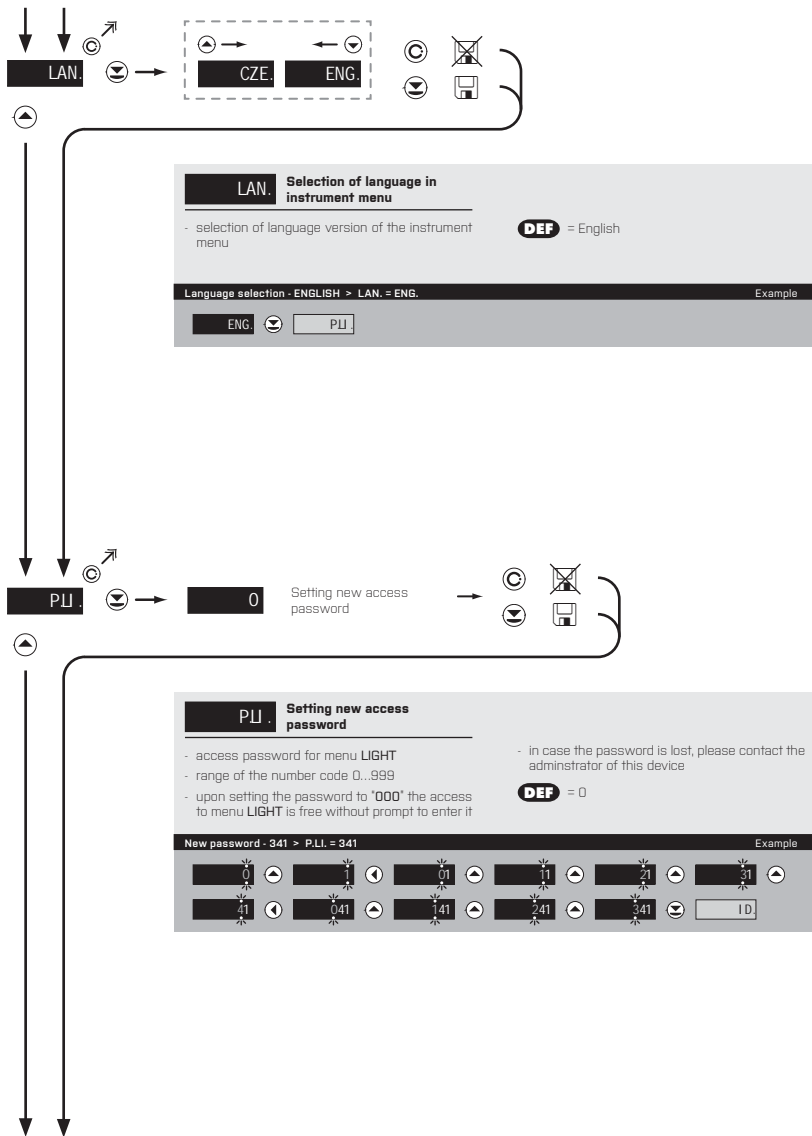

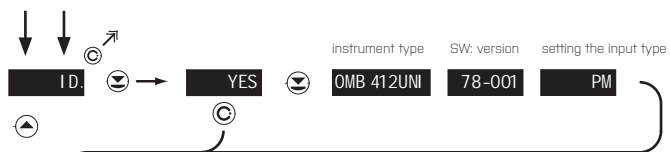

I D. Instrument SW version

- the display shows the type of instrument indication, SW number, SW version and current input setting [Mode]
- if SW version contains a letter in first position, then it is a customer SW
- after the identification is completed the menu is automatically exited and the instrument restores the measuring mode

142

Return to measuring mode



SETTING **PROFI**

For expert users

Complete instrument menu

Access is password protected

Possibility to arrange items of the **USER MENU**

Tree menu structure

6.0 SETTING "PROFI"

PROFI

Complete programming menu

- contains complete instrument menu and is protected by optional number code
- designed for expert users
- preset from manufacture is menu **LIGHT**

Switching over to "PROFI" menu



- access to **PROFI** menu
- authorization for access to **PROFI** menu does not depend on setting under item SER. > MNU.
- password protected access (unless set as follows under the item SER. > N.PA. > PRO =0)



- access to menu selected under item SER. > MNU. > **LIG./PRO.**
- password protected access (unless set as follows under the item SER. > N.PA. > LIG. =0)
- for access to **LIGHT** menu passwords for **LIGHT** and **PROFI** menu may be used



6. SETTING PROFI

Programming sch

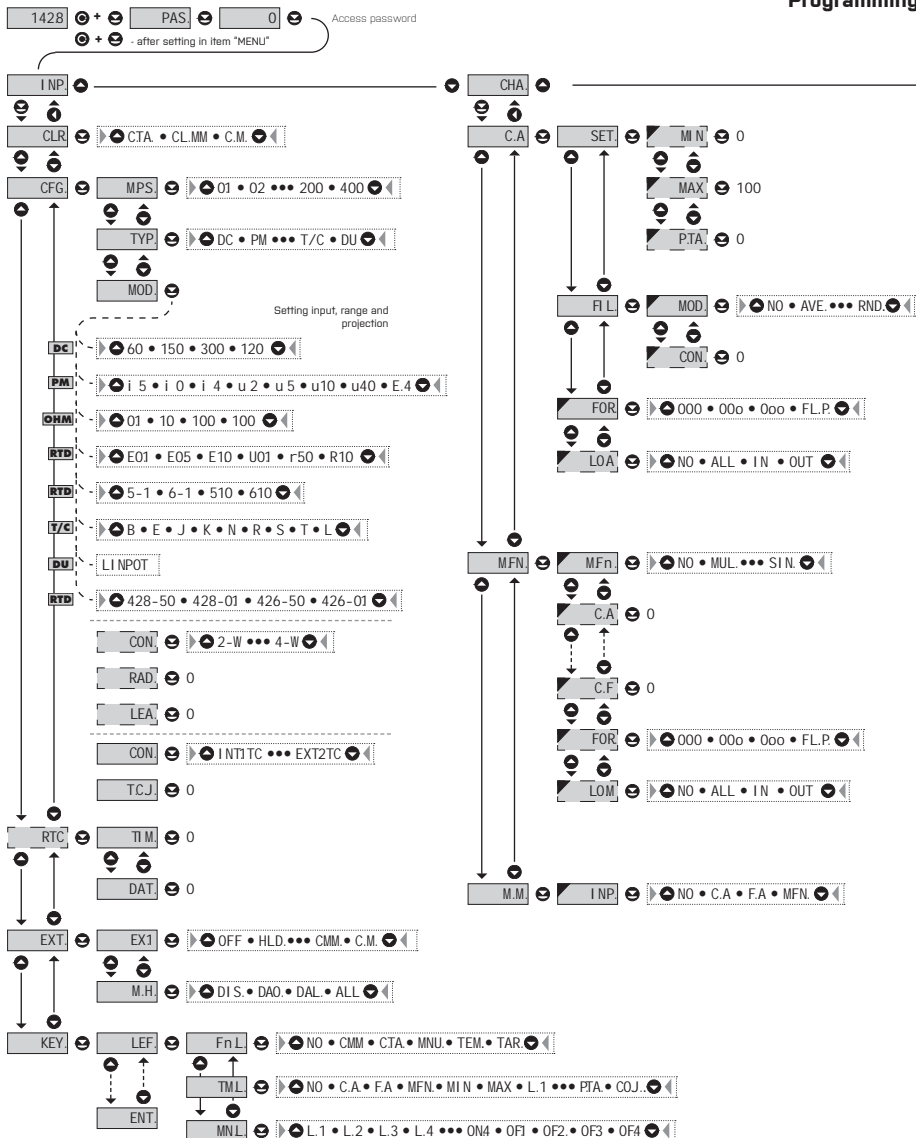

Scheme PROFI MENU

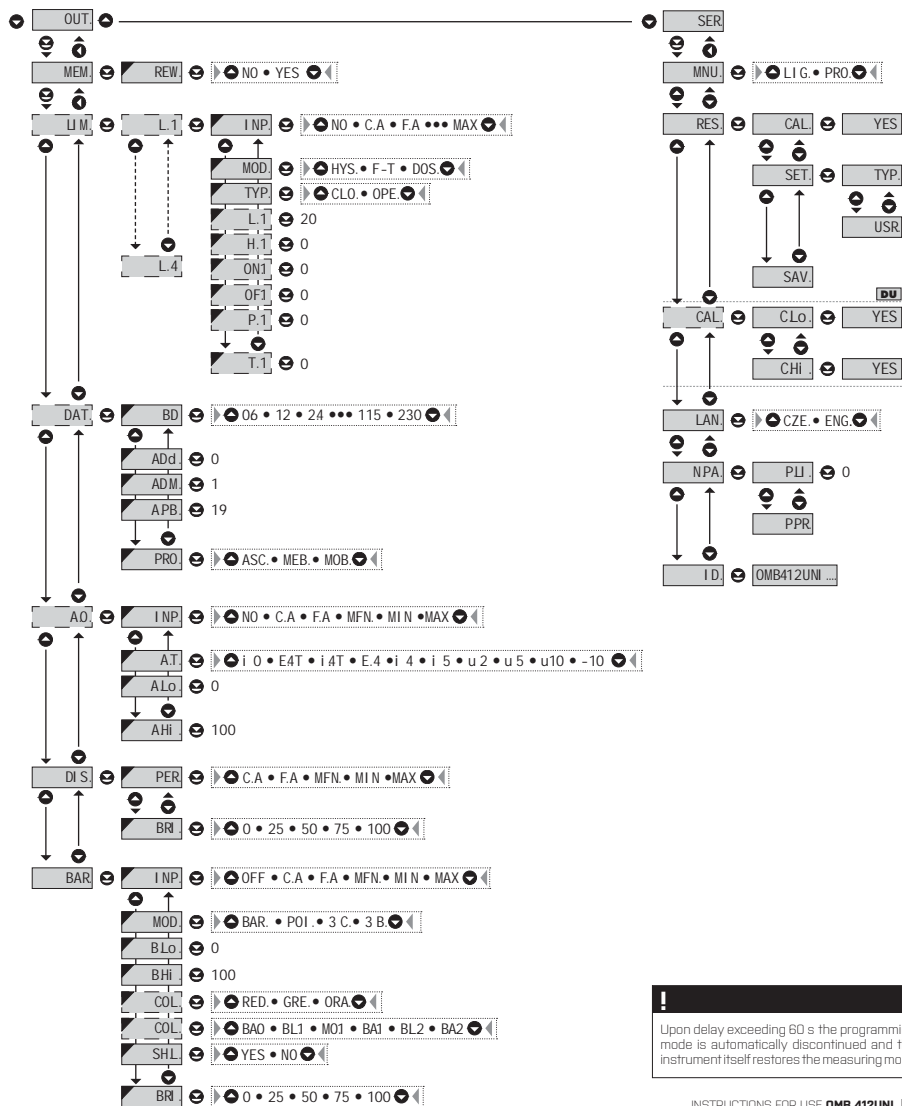

!
Upon delay exceeding 60 s the programming mode is automatically discontinued and the instrument itself restores the measuring mode

6. SETTING PROFI

6.1 SETTING "PROFI" - INPUT

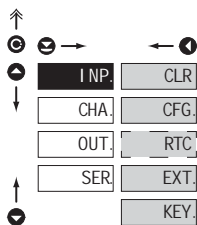

The primary instrument parameters are set in this menu

CLR.	Resetting internal values
CFG.	Selection of measuring range and parameters
RTC.	Setting date and time for option with RTC
EXT.	Setting external inputs functions
KEY.	Assigning further functions to keys on the instrument

6.1.1 RESETTING INTERNAL VALUES

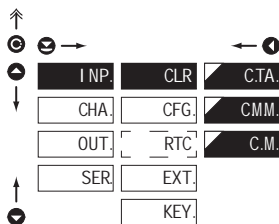

CLR.	Resetting internal values
C.T.A.	Tare resetting
C.M.M.	Resetting min/max value
C.M.	Resetting the instrument memory

- resetting memory for the storage of minimum and maximum value achieved during measurement
- resetting memory with data measured in the "FAST" or "RTC" modes
- not in standard equipment

6.1.2a SELECTION OF MEASURING RATE

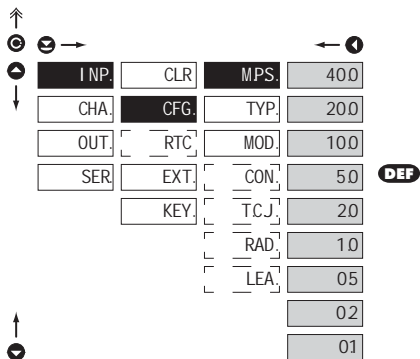

MPS. Selection of measuring rate

40.0	40,0 measurements/s
20.0	20,0 measurements/s
10.0	10,0 measurements/s
5.0	5,0 measurements/s
2.0	2,0 measurements/s
1.0	1,0 measurement/s
0.5	0,5 measurements/s
0.2	0,2 measurements/s
0.1	0,1 measurements/s

6.1.2b SELECTION OF „INSTRUMENT“ TYPE

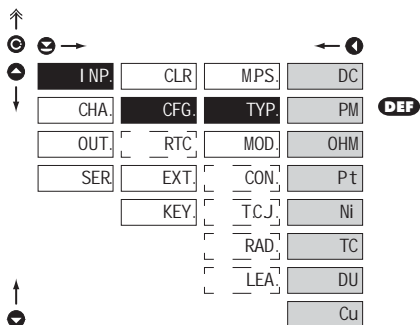

TYP. Selection of „instrument“ type

- selection of particular type of "instrument" is bound to relevant dynamic items

DC	DC voltmeter
PM	Process monitor
OHM	Ohmmeter
Pt	Thermometer for Pt xxx
Ni	Thermometer for Ni xxxx
TC	Thermometer pro thermocouples
DU	Display for linear potentiometers
Cu	Thermometer for Cu xxx

6. SETTING PROFI

6.1.2c

SELECTION OF MEASURING RANGE

↑ C → ← ↓	I.NP.	CLR	MPS.	DC	01	O.HM	DEF
	CHA.	CFG.	TYP.	150	1.0		
	OUT.	RTC	MOD.	300	10.0		
	SER.	EXT.	CON.	1.20	100		
	KEY.	T.C.J.					
		RAD.	DC - A	PM			
		LEA.	100	i 5			
			DEF	500	i 4.	DEF	
				010	V 2		
				0.25	V 5		
				0.50	V10		
				1.00	V40		
				5.00	E.4		
			RTD-Pt	RTD-Cu			
			DEF	E01	Cu1	DEF	
				E05	Cu 2		
				E10	Cu 3		
				U01	Cu 4		
				R50			
				R01			
			RTD-Ni	T/C			
			DEF	5-1	E		
				6-1	J	DEF	
				510	N		
				610	R		
					S		
					T		
			DU		L		
			DEF	LPO.			

↑
↓

MOD.	Selection of instrument measuring range		
Menu	Measuring range		
DC	60	±60 mV	
	150	±150 mV	
	300	±300 mV	
	120	±12 V	
DC - A	100	±100 V	
	250	±250 V	
	500	±500 V	
	0.10	±0.1 A	
	0.25	±0.25 A	
	0.50	±0.5 A	
	1.00	±1 A	
5.00	±5 A		
PM	Menu Measuring range		
	1.5	0...5 mA	
	1.0	0...20 mA	
	1.4	4...20 mA	
	u 2	±2 V	
	u 5	±5 V	
	u10	±10 V	
	u40	±40 V	
	E. 4	4...20 mA, with error statement of „underfl ow“ upon signal smaller than 3.36 mA	
	DHM	Menu Measuring range	
0.1		0...100 Ω	
1.0		0...1 kΩ	
10.0		0...10 kΩ	
100		0...100 kΩ	
PT	Menu Measuring range		
	E0.1	Pt 100 (3 850 ppm/°C)	
	E0.5	Pt 500 (3 850 ppm/°C)	
	E1.0	Pt 1000 (3 850 ppm/°C)	
	U0.1	Pt 100 (3 920 ppm/°C)	
	R.50	Pt 50 (3 910 ppm/°C)	
R1.0	Pt 100 (3 910 ppm/°C)		
NI	Menu Measuring range		
	5-1	Ni 1 000 (5 000 ppm/°C)	
	6-1	Ni 1 000 (6 180 ppm/°C)	
	510	Ni 10 000 (5 000 ppm/°C)	
	610	Ni 10 000 (6 180 ppm/°C)	
CU	Menu Measuring range		
	Cu.1	Cu 50 (4 260 ppm/°C)	
	Cu.2	Cu 1 00 (4 280 ppm/°C)	
	Cu.3	Cu 50 (4 260 ppm/°C)	
	Cu.4	Cu 100 (4 260 ppm/°C)	
T/C	Menu Type of thermocouple		
	B	B	
	E	E	
	J	J	
	K	K	
	N	N	
	R	R	
	S	S	
	T	T	
	L	L	

6.1.2d SELECTION OF TYPE OF SENSOR CONNECTION

RTD OHM T/C

↑
 Ⓞ →
 Ⓢ →
 ↓
 Ⓢ ←
 Ⓞ ←

INP.	CLR.	MPS.	2-W	DEF
CHA.	CFG.	TYP.	3-W	
OUT.	RTC.	MOD.	4-W	
SER.	EXT.	CON.		
	KEY.	RAD.		
		LEA.		

↑
 Ⓞ →
 Ⓢ →
 ↓
 Ⓢ ←
 Ⓞ ←

INP.	CLR.	MPS.	IN1	DEF
CHA.	CFG.	TYP.	IN2	
OUT.	RTC.	MOD.	EX1	
SER.	EXT.	CON.	EX2	
	KEY.	T.C.J.		

CON. Selection of type of sensor connection

RTD OHM

2-W 2-wire connection

3-W 3-wire connection

4-W 4-wire connection

T/C

IN1 Measurement without reference thermocouple

- measuring cold junction at instrument brackets

IN2 Measurement with reference thermocouple

- measuring cold junction at instrument brackets with anti-series connected reference thermocouple

EX1 Measurement without reference thermocouple

- the entire measuring set is working under invaried and constant temperature

EX2 Measurement with reference thermocouple

- when using compensation box

!

Method and procedure of setting the cold junctions is described in separate chapter on page 84

!

For thermocouple type "B" the items CON. and T.C.J. are not available

6. SETTING PROFI

6.1.2e SETTING TEMPERATURE OF COLD JUNCTION

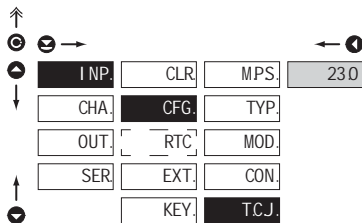
T/C

T.C.J. Setting temperature of cold junction

- range 0...99°C with compensation box

DEF = 23°C

6.1.2f ZERO OFFSET OF THE MEASUREMENT RANGE

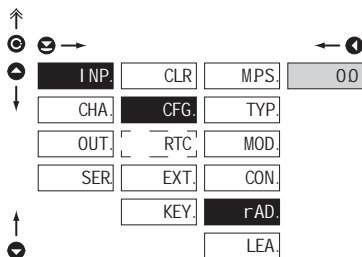
RTD OHM

RAD. Offset of the beginning of the measuring range

- in cases when it is necessary to offset the beginning of the range by certain value, e.g. while using sensor in measuring head

- entered directly in Ohm [0...999]

DEF = 0

6.1.2g COMPENSATION OF 2-WIRE CONDUCT

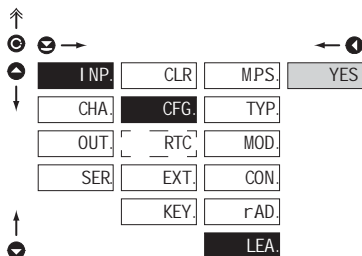
RTD OHM

LEA. Compensation of 2-wire conduct

- for measurement accuracy it is necessary to perform compensation of conduct always in case of 2-wire connection

- prior confirmation of the displayed prompt "YES" it is necessary to substitute the sensor at the end of the conduct by a short-circuit

DEF = 0

6.1.3 SETTING THE REAL TIME CLOCK

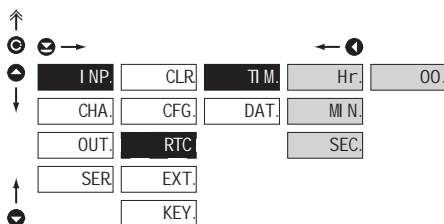

RTC Setting the real time clock (RTC)

TI.M. Time setting

- format 23.59.59

DAT. Date setting

- format DD.MM.YY

6.1.4a EXTERNAL INPUT FUNCTION SELECTION

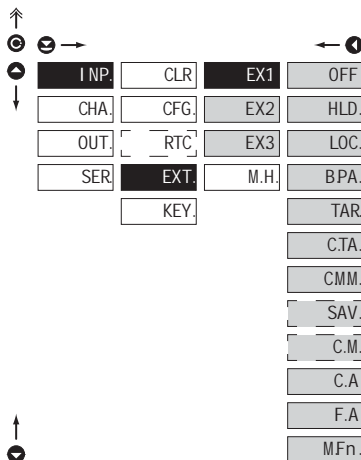

EXT. External input function selection

OFF Input is off

HLD. Activation of HOLD

LOC. Locking keys on the instrument

BPA. Activation of locking access into programming menu
LIGHT/PROFI

TAR. Tare activation

C.TA. Tare resetting

CMM. Resetting min/max value

SAV. Activation of measured data record in instrument memory

C.M. Clearing memory for option FAST/RTC

C.A. Displaying value of "Channel A"

F.A. Displaying value of "Channel A" after being processed by digital filters

MFn. Displaying value of "Mathematical function"

- **DEF** EX.1 > HLD.

- **DEF** EX.2 > LOC.

- **DEF** EX.3 > TAR.

*

Procedure identical for EX.2 and EX.3

6. SETTING PROFI

6.1.4b SELECTION OF FUNCTION "HOLD"

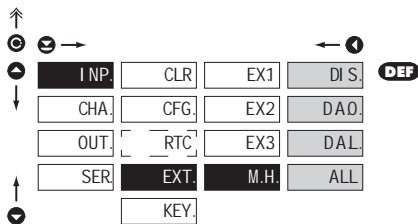

M.H. Selection of function "HOLD"

DI S.	"HOLD" locks only the value displayed
DAO.	"HOLD" locks the value displayed and on AD
DAL.	"HOLD" locks the value displayed, on AD and limit evaluation
ALL	"HOLD" locks the entire instrument

6.1.5a OPTIONAL ACCESSORY FUNCTIONS OF THE KEYS

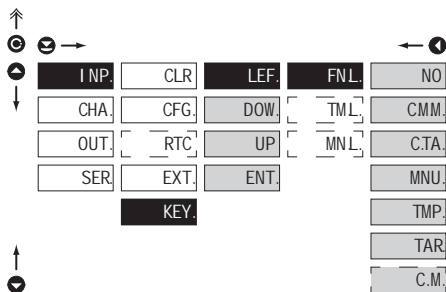

FNL. Assigning further functions to instrument keys

- „FNL.“ > executive functions

NO	Key has no further function
CMM.	Resetting min/max value
C.TA.	Tare resetting
MNU.	Direct access into menu on selected item
TMP.	Temporary projection of selected values
TAR.	Tare function activation
C.M.	Clearing memory

- clearing memory with data measured in modes "FAST" or "RTC"



Preset values of the control keys **DEF**

LEFT	Show Tare
UP	Show Max. value
DOWN	Show Min. value
ENTER	w/o function



Setting is identical for LEFT, DOWN, UP and ENTER

6.1.5b

OPTIONAL ACCESSORY FUNCTIONS OF THE KEYS - TEMPORARY PROJECTION

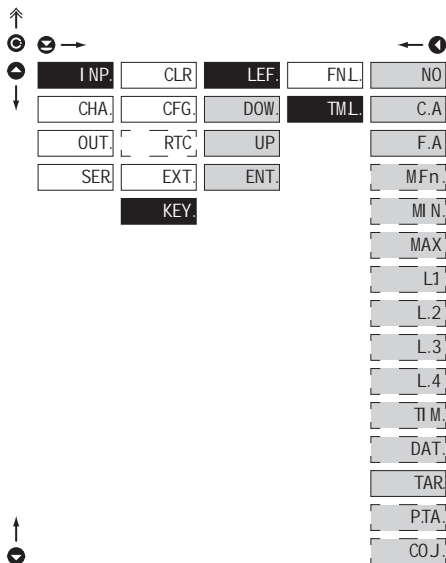
**TML.** Temporary projection of selected item

- „TML.“ > temporary projection of selected values
- "Temporary" projection of selected value is displayed for the time of keystroke
- "Temporary" projection may be switched to permanent by pressing **C** + "Selected key", this holds until the stroke of any key

NO	Temporary projection is off
C.A.	Temporary projection of "Channel A" value
F.A.	Temporary projection of "Channel A" value after processing digital filters
MFn.	Temporary projection of "Mathematic functions" value
MIN.	Temporary projection of "Min. value"
MAX.	Temporary projection of "Max. value"
L1	Temporary projection of "Limit 1" value
L2	Temporary projection of "Limit 2" value
L3	Temporary projection of "Limit 3" value
L4	Temporary projection of "Limit 4" value
TIM.	Temporary projection of "TIME" value
DAT.	Temporary projection of "DATE" value
TAR.	Temporary projection of "TARE" value
P.TA.	Temporary projection of "P. TARE" value
COJ.	Temporary projection of "CJC" value

!
Setting is identical for LEFT, DOWN, UP and ENTER

6. SETTING PROFI

6.1.5c

OPTIONAL ACCESSORY FUNCTIONS OF THE KEYS - DIRECT ACCESS TO ITEM

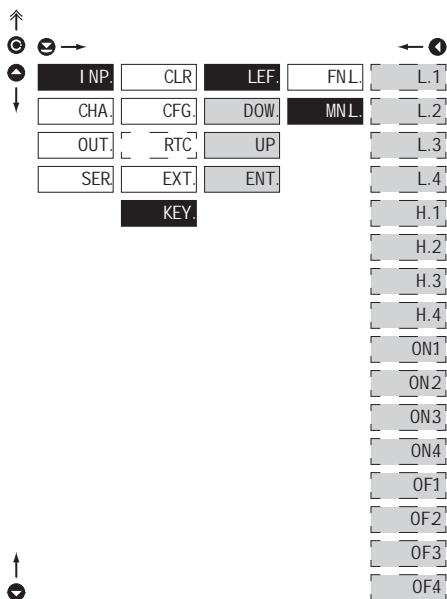

MN.L.	Assigning access to selected menu item
L.1	Direct access to item "L.1"
L.2	Direct access to item "L.2"
L.3	Direct access to item "L.3"
L.4	Direct access to item "L.4"
H.1	Direct access to item "H.1"
H.2	Direct access to item "H.2"
H.3	Direct access to item "H.3"
H.4	Direct access to item "H.4"
ON1	Direct access to item "ON.1"
ON2	Direct access to item "ON.2"
ON3	Direct access to item "ON.3"
ON4	Direct access to item "ON.4"
OF1	Direct access to item "OF.1"
OF2	Direct access to item "OF.2"
OF3	Direct access to item "OF.3"
OF4	Direct access to item "OF.4"



Setting is identical for LEFT, DOWN, UP and ENTER



6. SETTING PROFI

6.2 SETTING "PROFI" - CHANNELS

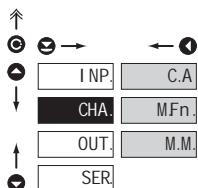

The primary instrument parameters are set in this menu

C.A.	Setting parameters of measuring "Channel A"
MFn.	Setting parameters of mathematic functions
M.M.	Selection of access and evaluation of Min/max value

6.2.1a DISPLAY PROJECTION

DC PM DU OHM

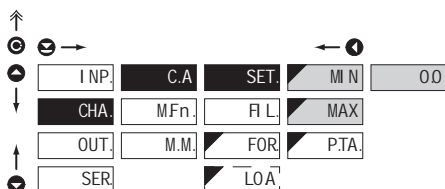

SET. Setting display projection

MIN	Setting display projection for minimum value of input signal
- range of the setting: -99...999	
DEF	= 0.0
MAX	Setting display projection for maximum value of input signal
- range of the setting: -99...999	
DEF	= 100.0

6.2.1b SETTING FIXED TARE

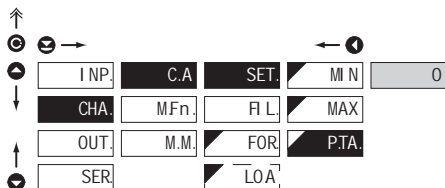

P.TA. Setting "Fixed tare" value

- setting is designed for the event when it is necessary to firmly shift the beginning of the range by known size
- when setting [P.TA. A: 0] is in effect, display does not show the "T" symbol
- range of the setting: -99...999
- DEF = 0

6.2.1d DIGITAL FILTERS

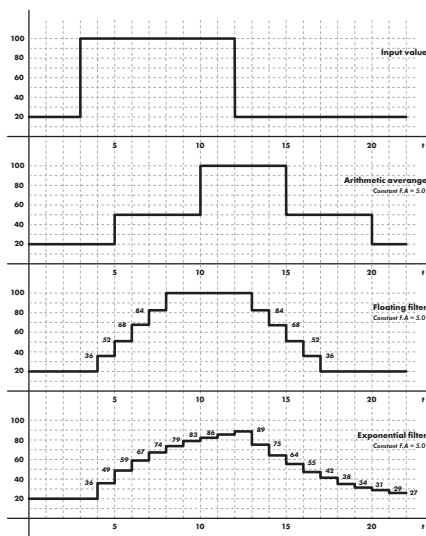
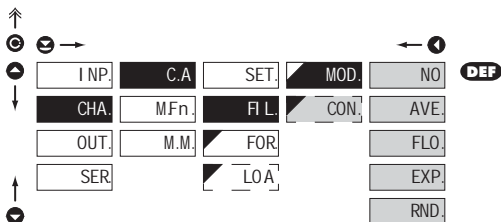
**MOD.** Selection of digital filters

- at times it is useful for better user projection of data on display to modify it mathematically and properly, wherefore the following filters may be used

NO Filters are off

AVE. Measured data average

- arithmetic average from given number [CON.] of measured values
- range 2...100

FLO. Selection of floating filter

- floating arithmetic average from given number [CON.] of measured data and updates with each measured value
- range 2...30

EXP. Selection of exponential filter

- integration filter of first prvniho grade with time constant [CON.] measurement
- range 2...100

RND. Measured value rounding

- is entered by any number, which determines the projection step [e.g. „CON.“ = 2.5 > display 0, 2.5, 5,...]

CON. Setting constants

- this menu item is always displayed after selection of particular type of filter

DEF = 2

6. SETTING PROFI

6.2.1e PROJECTION FORMAT - POSITIONING OF DECIMAL POINT

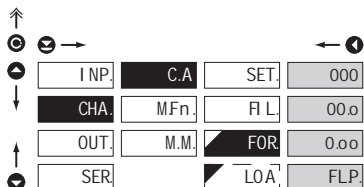

FOR Selection of decimal point

- the instrument allows for classic projection of a number with positioning of the DP as well as projection with floating DP, allowing to display a number in its most exact form „FL P.“

000 Setting DP - XXX

DEF

00.o Setting DP - XX.x

0.o.o Setting DP - X.xx

FLP. Floating DP

6.2.1f SELECTION OF STORING DATA INTO INSTRUMENT MEMORY

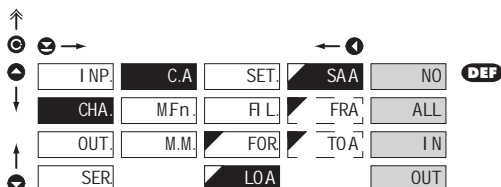

LOA Selection of storing data into instrument memory

- by selection in this item you allow to register values into instrument memory
- another setting in item "OUT. > MEM." (not in standard experiment)

NO Measured data is not stored

ALL Measured data is stored in memory

IN Only data measured within the set interval is stored in memory

OUT Only data measured outside the set interval is stored in memory

FRA Setting the initial interval value

- setting range: -99...999

TOA Setting the final interval value

- setting range: -99...999

6.2.2a

MATHEMATIC FUNCTIONS

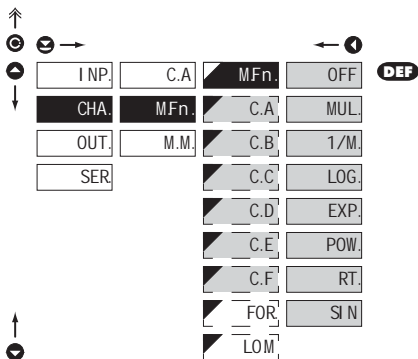
**M.Fn.** Selection of mathematic functions

OFF Mathematic functions are off

MUL. Multinomial

$$Ax^5 + Bx^4 + Cx^3 + Dx^2 + Ex + F$$

1/M. $1/x$

$$\frac{A}{x^5} + \frac{B}{x^4} + \frac{C}{x^3} + \frac{D}{x^2} + \frac{E}{x} + F$$

LOG. Logarithm

$$A \times \ln\left(\frac{Bx + C}{Dx + E}\right) + F$$

EXP. Exponential

$$A \times e^{\left(\frac{Bx + C}{Dx + E}\right)} + F$$

POW. Power

$$A \times (Bx + C)^{(Dx + E)} + F$$

RT. Root

$$A \times \sqrt{\frac{Bx + C}{Dx + E}} + F$$

SIN Sin x

$$A \sin^5 x + B \sin^4 x + C \sin^3 x + D \sin^2 x + E \sin x + F$$

C.- Setting constants for calculation of mat.functions

- this menu is displayed only after selection of given mathematic function

6. SETTING PROFI

6.2.2b MATHEMATIC FUNCTIONS - DECIMAL POINT

Navigation diagram for setting the decimal point:

- Start at **FOR** (Default)
- Press **LOM** to reach the decimal point selection screen.
- Available options: 000, 00.o, 0.o.o, FLP.

FOR Selection of decimal point

- the instrument allows for classic projection of a number with positioning of the DP as well as projection with floating DP, allowing to display a number in its most exact form „FL P“.

000	Setting DP - XXX
00.o	Setting DP - XX.x
0.o.o	Setting DP - X.xx
FLP.	Floating DP

DEF

6.2.2c MATHEMATIC FUNCTIONS - SELECTION OF STORING DATA INTO INSTRUMENT MEMORY

Navigation diagram for selecting data storage options:

- Start at **SAM** (Default)
- Press **NO** to select the storage option.
- Available options: NO, ALL, IN, OUT.

LOM Selection of storing data into instrument memory

- by selection in this item you allow to register values into instrument memory
- another setting in item "OUT. > MEM." (not in standard experiment)

NO	Measured data is not stored
ALL	Measured data is stored in memory
IN	Only data measured within the set interval is stored in memory
OUT	Only data measured outside the set interval is stored in memory

FRM	Setting the initial interval value
- setting range: -99...999	
TOM	Setting the final interval value
- setting range: -99...999	

6.2.3

SELECTION OF EVALUATION OF MIN/MAX VALUE

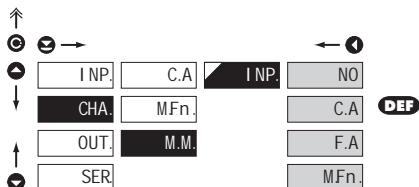
INP. Selection of evaluation of min/max value

- selection of value from which the min/max value will be calculated

NO Evaluation of min/max value is off

C.A From "Channel A"

F.A From "Channel A" after digital filters processing

MFn. From "Mathematic functions"

6. SETTING PROFI

6.3 SETTING „PROFI“ - OUTPUTS

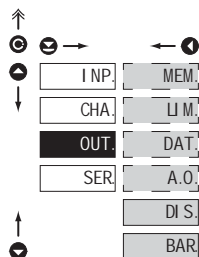

In this menu it is possible to set parameters of the instrument output signals

MEM.	Setting data logging into memory
U.M.	Setting type and parameters of limits
DAT.	Setting type and parameters of data output
A.O.	Setting type and parameters of analog output
DI.S.	Setting display projection and brightness
BAR.	Setting bargraph projection and brightness

6.3.1a SELECTION OF MODE OF DATA LOGGING INTO INSTRUMENT MEMORY

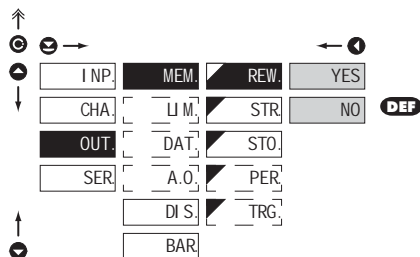

REW. Selection of the mode of data logging

- selection of the mode in the event of full instrument memory

NO	Rewriting values prohibited
YES	Rewriting values permitted, the oldest get rewritten by the latest

6.3.1b SETTING DATA LOGGING INTO INSTRUMENT MEMORY - RTC

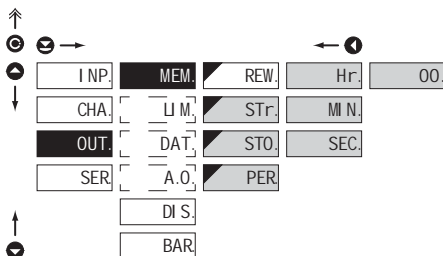

RTC

The lowest recording rate possible is once a day, the highest is every second. Under exceptional circumstances it is possible to set the rate to 8 times per second by entering the recording period as 00:00:00. However, this mode is not recommended due to the memory overload. Recordings are realised in a timeframe of one day and are repeated periodically every following day. Recordings can take place either inside or outside of selected time intervals. The duration of re-writing can be determined by the number of channels recorded as well as by the recording rate.

STR. Start of data logging into instrument memory

- time format HH:MM:SS

STO. Stop data logging into instrument memory

- time format HH:MM:SS

PER. Period of data logging into instrument memory

- determines the period in which values will be logged in an interval delimited by the time set under items **STR.** and **STO.**
- time format HH:MM:SS
- records are made on a daily basis in selected interval and period
- item not displayed if 'SAV.' is selected in menu (INP. > EXT.)

6.3.1c SETTING DATA LOGGING INTO INSTRUMENT MEMORY - FAST

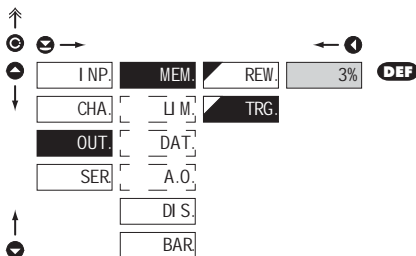

FAST

The memory operates on the basis of memory oscilloscope. Select an area of 0...100% of the memory capacity [100% represents 8 192 individual recordings for a single channel measurement]. This area is filled cyclically up to the point when the recording starts (activated by the front panel button or by an external input). When the remaining memory capacity fills up the recording stops. A new recording is possible after the deletion of the latest recording. It is possible to abort a recording before its completion by reading out the data.

TRG. Setting logging data into inst. memory

- logging data into inst. memory is governed by the following selection, which determines how many percent of the memory is reserved for data logging prior to initiation of trigger impulse
- initialization is on ext. input or button
- setting in range 1...100 %
- when setting 100 %, datalogging works in the mode **ROLL** > data keep getting rewritten in cycles

1. Memory initialization

- clear memory (ext.input, button)
- LED "M" flashes, after reading **TRG. (%)** memory is permanently shining. In **ROLL** flashes constantly.

2. Triggering

- external input, button
- after the memory LED is full "M" turns off
- in the **ROLL** mode the trigger ends datalogging and LED turns off

3. Termination

- ext. input, button or reading data via RS

6. SETTING PROFI

MODE > HYSTER • FR.: TO • DOSING

DESCRIPTION OF RELAY FUNCTION

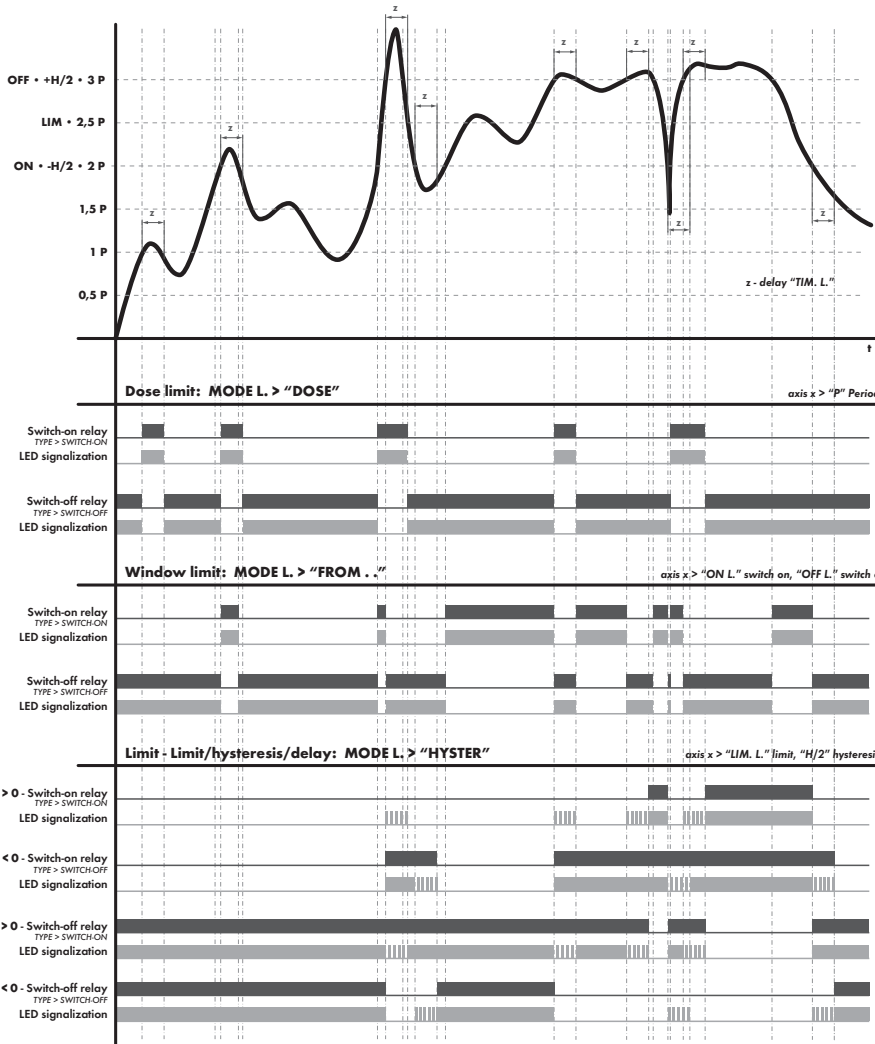

6.3.2a SELECTION OF INPUT FOR LIMITS EVALUATION

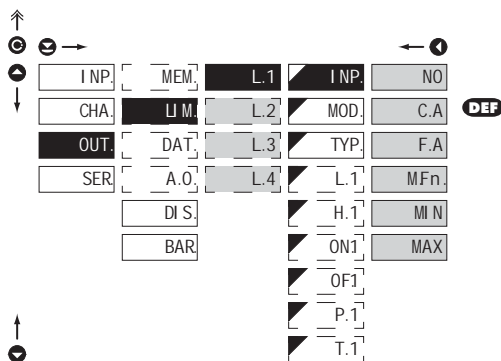

I.NP. Selection evaluation of limits

- selection of value from which the limit will be evaluated

NO	Limit evaluation is off
C.A	Limit evaluation from "Channel A"
F.A	Limit evaluation from "Channel A" after digital filters processing
MFn.	Limit evaluation from "Mathematic functions"
MIN	Limit evaluation from "Min. value"
MAX	Limit evaluation from "Max. value"

Setting is identical for L.1, L.2, L.3 and L.4

6.3.2b SELECTION OF TYPE OF LIMIT

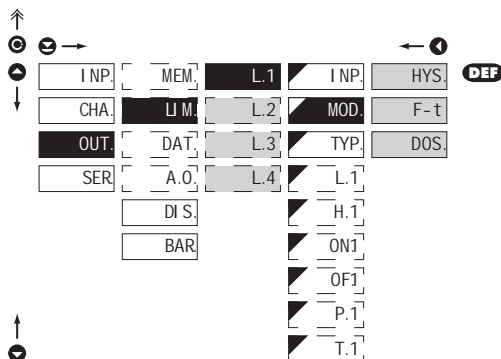

MOD. Selection the type of limit

- | | |
|------|---|
| HYS. | Limit is in mode "Limit, hysteresis, delay" |
|------|---|
- for this mode the parameters of "L.1" are set, at which the limit will shall react, "H.1" the hysteresis range around the limit (LIM $\pm 1/2$ HYS) and time "T.1" determining the delay of relay switch-on
- | | |
|-----|-------------|
| F-t | Frame limit |
|-----|-------------|
- for this mode the parameters are set for interval "ON1" the relay switch-on and "OF1" the relay switch-off
- | | |
|------|-----------------------|
| DOS. | Dose limit (periodic) |
|------|-----------------------|
- for this mode the parameters are set for "P.1" determining the limit value as well as its multiples at which the output is active and "T.2" indicating the time during which is the output active

Setting is identical for L.1, L.2, L.3 and L.4

6. SETTING PROFI

6.3.2c SELECTION OF TYPE OF OUTPUT

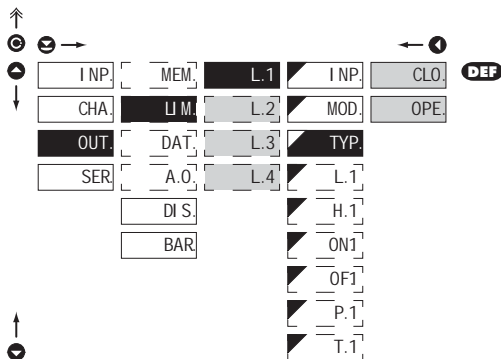

TYP.	Selection of type of output
CLO.	Output switches on when condition is met
OPE.	Output switches off when condition is met
<p>!</p> Setting is identical for L. 1, L. 2, L. 3 and L. 4	

6.3.2d SETTING VALUES FOR LIMITS EVALUATION

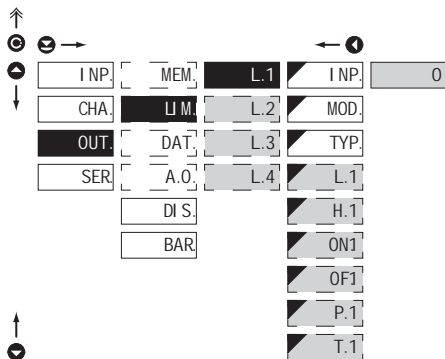

L1	Setting limit for switch-on
- for type "HYS."	
H.1	Setting hysteresis
- for type "HYS."	
- indicates the range around the limit (in both directions, LIM. $\pm 1/2$ HYS.)	
ON1	Setting the outset of the interval of limit switch-on
- for type "F"	
OF1	Setting the end of the interval of limit switch-on
- for type "F"	
P.1	Setting the period of limit switch-on
- for type "DOS."	
T.1	Setting the time switch-on of the limit
- for type "HYS." and "DOS."	
- setting within the range: $\pm 0...99.9$ s	
- positive time > relay switches on after crossing the limit [L. 1] and the set time [T. 1]	
- negative time > relay switches off after crossing the limit [L. 1] and the set negative time [T. 1]	
<p>!</p> Setting is identical for L. 1, L. 2, L. 3 and L. 4	

6.3.3a SELECTION OF DATA OUTPUT BAUD RATE

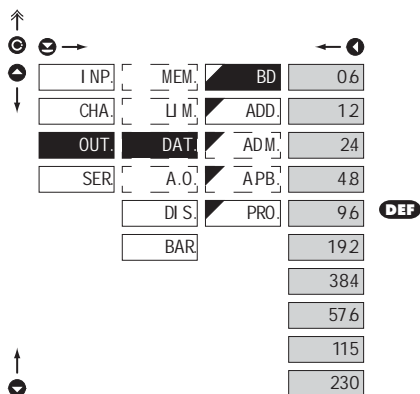
**BD** Selection of data output baud rate

06	Rate - 600 Baud
12	Rate - 1200 Baud
24	Rate - 2 400 Baud
48	Rate - 4 800 Baud
96	Rate - 9 600 Baud
192	Rate - 19 200 Baud
384	Rate - 38 400 Baud
576	Rate - 57 600 Baud
115	Rate - 115 200 Baud
230	Rate - 230 400 Baud

6.3.3b SETTING INSTRUMENT ADDRESS

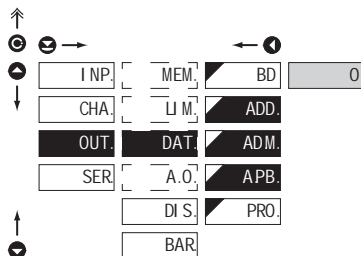
**ADD.** Setting instrument address

- setting in range 0...31
- **DEF** = 00

ADM. Setting instrument address - MODBUS

- setting in range 1...247
- **DEF** = 1

APB. Setting instrument address - PROFIBUS

- setting in range 1...127
- **DEF** = 19

6. SETTING PROFI

6.3.3c SELECTION OF DATA OUTPUT PROTOCOL

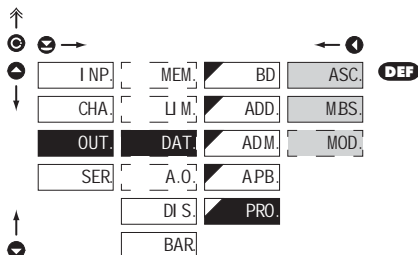

PRO. Selection of the type of analog output

ASCII. Data protocol ASCII

MBS. Data protocol DIN MessBus

MOD. Data protocol MODBUS-RTU

- option is available only for RS 485

6.3.4a SELECTION OF INPUT FOR ANALOG OUTPUT

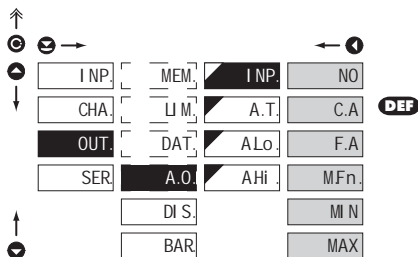

I.NP. Selection evaluation analog output

- selection of value from which the analog output will be evaluated

NO AD evaluation is off

C.A AD evaluation from "Channel A"

F.A AD evaluation from "Channel A" after digital filters processing

M.Fn. AD evaluation from "Math. functions"

MIN AD evaluation from "Min. value"

MAX AD evaluation from "Max. value"

6.3.4b SELECTION OF THE TYPE OF ANALOG OUTPUT

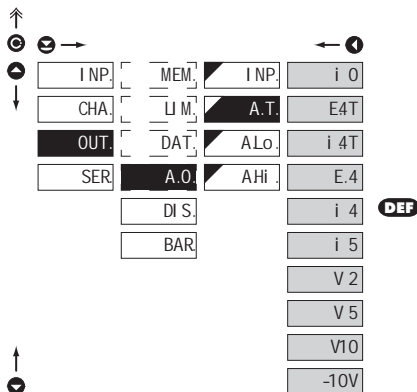

TYP. Selection of the type of analog output

i 0 Type - 0...20 mA

E4T Type: 4...20 mA with indication

- with broken loop detection and indication of error statement (< 3,6 mA)

i 4T Type: 4...20 mA with indication

- with broken loop detection (< 3,6 mA)

E.4 Type: 4...20 mA with indication

- with indic. of error statement (< 3,6 mA)

i 4 Type - 4...20 mA

i 5 Type - 0...5 mA

V 2 Type - 0...2 V

V 5 Type - 0...5 V

V10 Type - 0...10 V

-10 Type - ±10 V

6.3.4c SETTING THE ANALOG OUTPUT RANGE

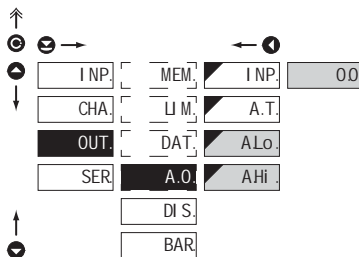

A.O. Setting the analog output range

- analog output is isolated and its value corresponds with displayed data. It is fully programmable, i.e. it allows to assign the AO limit points to two arbitrary points of the entire measuring range

ALo. Assigning the display value to the beginning of the AO range

- range of the setting: -99...999

- **DEF** = 0

AHi. Assigning the display value to the end of the AO range

- range of the setting: -99...999

- **DEF** = 100

6. SETTING PROFI

6.3.5a SELECTION OF INPUT FOR DISPLAY PROJECTION

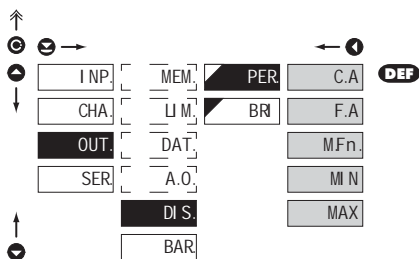

PER Selection display projection

- selection of value which will be shown on the instrument display

C.A	Projection of values from "Channel A"
F.A	Projection of values from "Channel A" after digital filters processing
M.Fn.	Projection of values from "Math. functions"
M N	Projection of values From "Min. value"
MAX	Projection of values from "Max. value"

6.3.5b SELECTION OF DISPLAY BRIGHTNESS

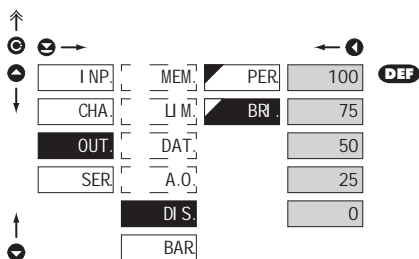

BR Selection of display brightness

- by selecting display brightness we may appropriately react to light conditions in place of instrument location

0	Display is off
25	Display brightness - 25%
50	Display brightness - 50%
75	Display brightness - 75%
100	Display brightness - 100%

- after keystroke display turns on for 10 s

6.3.6a BARGRAPH - SELECTION OF PROJECTION INPUT

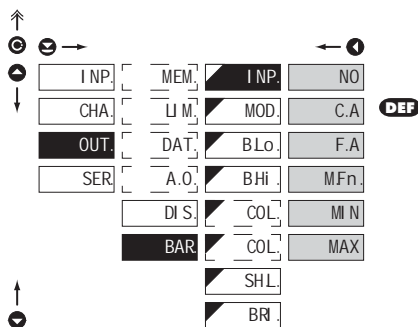

I NP. Selection of bargraph evaluation

- selection of value from which the analog output will be evaluated

- Analog evaluation is off

NO	Analog evaluation is off
C.A	From "Channel A"
F.A	From "Channel A" after digital filter modification
MFn.	From "Mathematic function"
MI N	From "Minimum value"
MAX	From "Maximum value"

6.3.6b BARGRAPH - SELECTION OF PROJECTION MODE

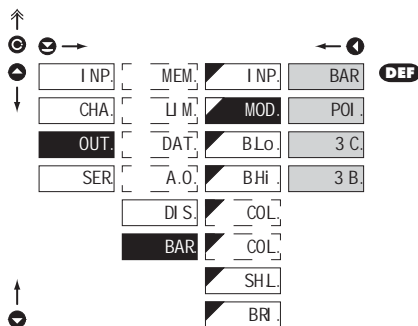

MOD. Selection of bargraph projection mode

BAR Column projection

- the display shows only a column in one color

POI. Point projection

- the display shows one point in one color

3 C. 3-colored column projection

- change of color is determined by set limits [COL. > bA0; bA1; bA2]

- upon exceeding the limit the color of the entire display, i.e. there is always only one column of one color lit

3 B. 3-colored bar projection, cascade

- change of color is determined by the said limits [COL. > bA0; bA1; bA2]

- upon exceeding a limit color of the given display section is changing, i.e. the display may shine up to three colors at a time

6. SETTING PROFI

6.3.6c BARGRAPH - SETTING THE PROJECTION RANGE

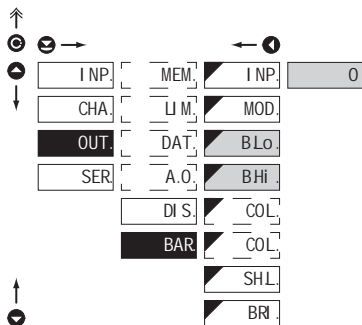

BAR Setting the bargraph projection range

- setting is the same as the setting for main display projection

BLo Setting bargraph projection for minimum input signal value

- range of the setting is -99...999
- **DEF** = 0

BHi Setting bargraph projection for maximum input signal value

- range of the setting is -99...999
- **DEF** = 100

6.3.6d BARGRAPH - SETTING COLOR

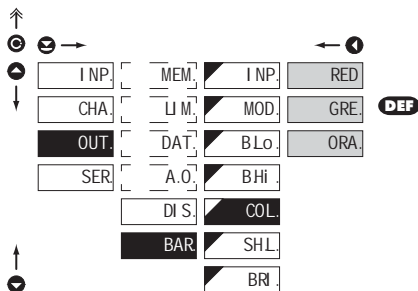

COL. Selection of bargraph color

- the item "COL." is displayed only with selected mode ("BAR. > MOD.") "BAR." or "POL."

RED Red color

GRE. Green color

ORA. Orange color

6.3.6e BARGRAPH - COLOR SETTING

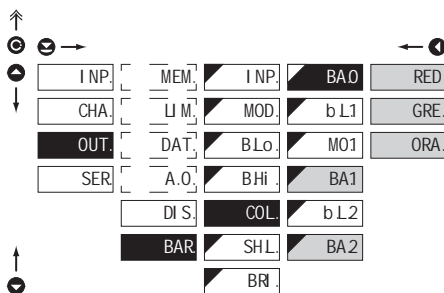

BA.0 Selection of bargraph color

- the item "COL." is displayed only with selected mode ("BAR. > MOD.1" "3 C." or "3 B.")

RED Red color

GRE. Green color

ORA. Orange color

- **DEF** = Green (Band 0)
- **DEF** = Orange (Band 1)
- **DEF** = Red (Band 2)

! Setting is identical for BA.1 and BA.2

6.3.6f BARGRAPH - SETTING THE COLOR CHANGES BANDS

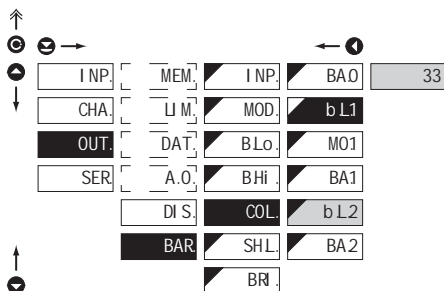

b.L1 Setting color limits for color projection

- the item "COL." is displayed only with selected mode ("BAR. > MOD.1" "3 C." or "3 B.")
- items „b.L1" and „b.L2" determine the borders of the bargraph color changes

b.L1 Boundary between bands 0 - 1

b.L2 Boundary between bands 1 - 2

- **DEF** = 33 [b.L1]
- **DEF** = 66 [b.L2]

! Setting is identical for B.L.2

6. SETTING PROFI

6.3.6g BARGRAPH - SELECTION OF INVERSE PROJECTION

INP.	MEM.	INP.	BA0	NOR	DEF
CHA.	UM.	MOD.	bL1	INV.	
OUT.	DAT.	BLo	MO1		
SER.	A.O.	BHi	BA1		
	DIS.	COL.	bL2		
	BAR.	SHL.	BA2		
		BR.			

MO1 Selection of inverse projection of "Band 0"

- the item "COL." is displayed only with selected mode ("BAR. > MOD.") "3 C." or "3 B."
- setting "MO1" is designed for projection where indication of zero center is required

NOR. Column in "bA.0" moves from left to right

INV. Column in "bA.0" moves from right to left

6.3.6h BARGRAPH - SELECTION OF LIMITS PROJECTION

INP.	MEM.	INP.	YES	DEF
CHA.	UM.	MOD.	NO	
OUT.	DAT.	BLo		
SER.	A.O.	BHi		
	DIS.	COL.		
	BAR.	COL.		
		SHL.		
		BR.		

SHL. Selection of limit projection on the bargraph

- limits are always displayed orange, always by one degree lighter or darker

YES Limits are projected

NO Limits are not projected

6.3.6i BARGRAPH - SELECTION OF DISPLAY BRIGHTNESS

INP.	MEM.	INP.	100	DEF
CHA.	UM.	MOD.	75	
OUT.	DAT.	BLo	50	
SER.	A.O.	BHi	25	
	DIS.	COL.	0	
	BAR.	SHL.		
		BR.		

BR. Selection of bargraph brightness

0 Bargraph is off

- after pres. the key the display lights up for 10s

25 Brightness - 25%

50 Brightness - 50%

75 Brightness - 75%

100 Brightness - 100%



6. SETTING PROFI

6.4 SETTING "PROFI" - SERVICE

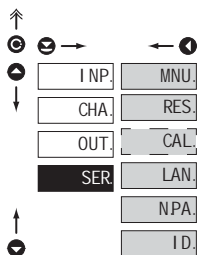

The instrument service functions are set in this menu

MNU.	Selection of menu type LIGHT/PROFI
RES.	Restore instrument manufacture setting and calibration
CAL.	Input range calibration for „DU“ version
LAN.	Language version of instrument menu
NPA.	Setting new access password
ID.	Instrument identification

6.4.1 SELECTION OF TYPE OF PROGRAMMING MENU

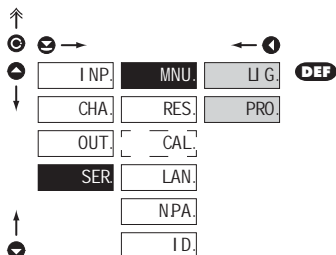

MNU. Selection of menu type - LIGHT/PROFI

- enables setting the menu complexity according to user needs and skills

LJ G. Active LIGHT menu

- simple programming menu, contains only items necessary for configuration and instrument setting
- linear menu > items one after another

PRO. Active PROFI menu

- complete programming menu for expert users
- tree menu



Change of setting is valid upon next access into menu

6.4.2 RESTORATION OF MANUFACTURE SETTING

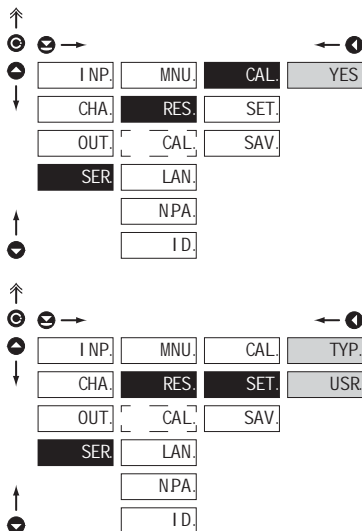
**RES.** Restoration of manufacture setting

- in the event of error setting or calibration, manufacture setting may be restored

CAL. Restoration of manufacture calibration of the instrument

- prior executing the changes you will be asked to confirm you selection ,YES'

SET. Restoration of instrument manufacture setting**TYP.** Restoration of instrument manufacture setting

- generating the manufacture setting for currently selected type of instrument (items marked DEF)

USR. Restoration of instrument user setting

- generating the instrument user setting, i.e. setting stored under SER/RES/SAV.

SAV. Save instrument user setting

- storing the user setting allows the operator to restore it in future if needed



After restoration the instrument switches off for couple seconds

JOBS PERFORMED**RESTORE**

JOBS PERFORMED	RESTORE	
	CALIBRATION	SETTING
cancel USER menu rights	✓	✓
deletes table of items order in USER - LIGHT menu	✓	✓
adds items from manufacture to LIGHT menu	✓	✓
deletes data stored in FLASH	✓	✓
cancel or linearization tables	✓	✓
clears tare	✓	✓
restore manufacture calibration	✓	✗
restore manufacture setting	✗	✓

6. SETTING PROFI

6.4.3 CALIBRATION - INPUT RANGE

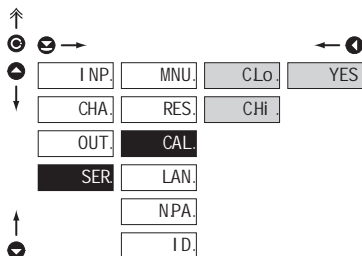
DU

CAL. Input range calibration

- when "C.Lo." is displayed, move the potentiometer traveller to the required minimum position and confirm by „Enter“, calibration is confirmed by „YES“
- when "C.Hi." is displayed, move the potentiometer traveller to the required maximum position and confirm by „Enter“, calibration is confirmed by „YES“

6.4.4 SELECTION OF INSTRUMENT MENU LANGUAGE VERSION

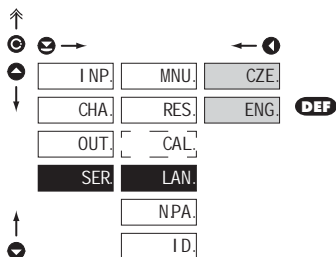

LAN. Selection of instrument menu language version

- CZE.** Instrument menu is in Czech
- ENG.** Instrument menu is in English

6.4.5 SETTING NEW ACCESS PASSWORD

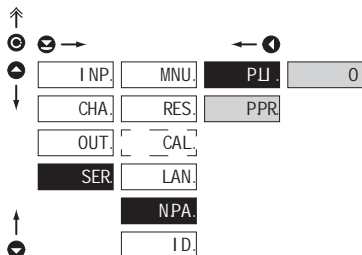

NPA. Setting new password for access to LIGHT and PROFi menu

- this option allows to change the numeric code, which blocks the access into LIGHT and PROFi menu.
- numerical code range: 0...999
- universal passwords in the event of loss: LIGHT Menu > „177“ PROFi Menu > „915“

6.4.6

INSTRUMENT IDENTIFICATION

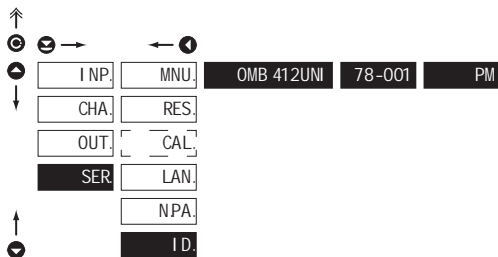
**ID.** Projection of instrument SW version

- display shows type identification of the instrument, SW number, SW version and current input setting (Mode)
- if the SW version reads a letter on first position, it is a customer SW

	Pos.	Description
IDENT.	1.	type of instrument
	2.	SW. number - version
	3.	the input type



SETTING USER

For user operation

Menu items are set by the user (Profi/Light) as per request

Access is not password protected

Optional menu structure either tree (PROFI) or linear (LIGHT)

7.0 SETTING ITEMS INTO "USER" MENU

- **USER** menu is designed for users who need to change only several items of the setting without the option to change the primary instrument setting (e.g. repeated change of limit setting)
- there are no items from manufacture permitted in **USER** menu
- on items indicated by inverse triangle  L1
- setting may be performed in **LIGHT** or **PROFI** menu, with the **USER** menu then overtaking the given menu structure

Setting

flashing legend - current setting is displayed



NO

item will not be displayed in USER menu

YES

item will be displayed in USER menu with editing option

SHO.

item will be solely displayed in USER menu

Setting sequence of items in "USER" menu

In compiling USER menu from active LIGHT menu the items (max. 10) may be assigned a sequence, in which they will be projected in the menu

setting projection sequence



Example of ranking the order of menu items in the "USER" menu

In this example we want to have a direct access to menu items Limit 1 and Limit 2 (example show is for the Light menu, but can equally be used in the Profi menu).

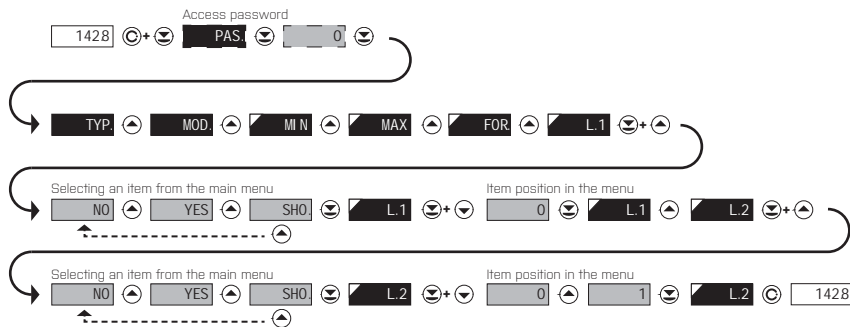

The result of this setting is that when the [OK] button is pressed, the display will read „L. 1“. By pressing [ESC] button you confirm your selection and then you can set the desired limit value, or by pressing the [OK] button you can go to setting of „L. 2“ where you can proceed identically as with Limit one.

You can exit the setting by pressing the [ESC] button by which you store the latest setting and pressing the [OK] button will take you back to the measuring mode

8. METHOD OF MEASURING THE CJJ

Instrument with input for temperature measurement with thermocouple allows to set two types of measurement of cold junction.

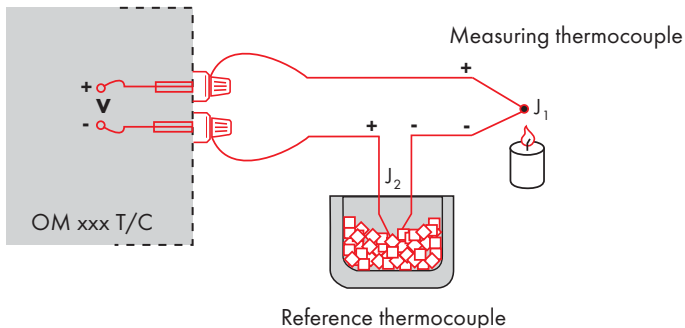

WITH REFERENCE THERMOCOUPLE

- a reference thermocouple may be located in the same place as the measuring instrument or in place with stable temperature/compensation box
- when measuring with reference thermocouple set **CON.** in the instrument menu to **IN2** or **EX2**
- when using a thermostat (a compensation box or environment with constant temperature) set in the instrument menu **TCJ.** its temperature (applies for setting **CON.** to **EX2**)
- if the reference thermocouple is located in the same environment as the measuring instrument then set in the instrument menu **CON.** to **IN2.** Based on this selection the measurement of the ambient temperature is performed by a sensor located in the instrument terminal board

WITHOUT REFERENCE THERMOCOUPLE

- inaccuracy originating from the creation of dissimilar thermocouples on the transition point terminal/conductor of the thermocouple is not compensated for in the instrument
- when measuring without reference thermocouple set **CON.** in the instrument menu to **IN1** or **EX1**
- when measuring temperature without reference thermocouple the error in measured data may be as much as 10°C (applies for setting **CON.** to **EX1**)

ERROR	CAUSE	ELIMINATION
E.d._	Number is too small (large negative) to be displayed	change DP setting, channel constant setting
E.d.-	Number is too large to be displayed	change DP setting, channel constant setting
E.t._	Number is outside the table range	increase table values, change input setting (channel constant setting)
E.t.-	Number is outside the table range	increase table values, change input setting (channel constant setting)
Ei._	Input quantity is smaller than permitted input quantity range	change input signal value or input (range) setting
Ei.-	Input quantity is larger than permitted input quantity range	change input signal value or input (range) setting
EHw.	A part of the instrument does not work properly	send the instrument for repair
EEE	Data in EEPROM corrupted	perform restoration of manufacture setting, upon repeated error statement send instrument for repair
ESE.	Data in EEPROM outside the range	perform restoration of manufacture setting, upon repeated error statement send instrument for repair
ECL.	Memory was empty (presetting carried out)	upon repeated error statement send instrument for repair, possible failure in calibration
Eou.	Analogue output current loop disconnected	check wire connection

10. DATA PROTOCOL



The instruments communicate via serial line RS232 or RS485. For communication they use the ASCII protocol. Communication runs in the following format:

ASCII: 8 bit, no parity, one stop bit

DIN MessBus: 7 bit, even parity, one stop bit

The transfer rate is adjustable in the instrument menu. The instrument address is set in the instrument menu in the range of 0 ÷ 31. The manufacture setting always presets the ASCII protocol, rate of 9600 Baud, address 00. The type of line used - RS232 / RS485 - is determined by an output board automatically identified by the instrument.

The commands are described in specifications you can find at www.orbit.merret.eu or software DM Link.

DETAILED DESCRIPTION OF COMMUNICATION VIA SERIAL LINE

EVENT	TYPE	PROTOCOL	TRANSMITTED DATA	
Data solicitation (PC)	232	ASCII	# A A A <CR>	
		MessBus	No - data is transmitted permanently	
	485	ASCII	# A A A <CR>	
		MessBus	<SADR> <ENQ>	
Data transmission (instrument)	232	ASCII	> D (D) (D) (D) (D) (D) (D) (D) (D) (D) (D) (D) (D) <CR>	
		MessBus	<STX> D (D) (D) (D) (D) (D) (D) (D) (D) (D) (D) (D) (D) <ETX> <BCC>	
	485	ASCII	> D (D) (D) (D) (D) (D) (D) (D) (D) (D) (D) (D) (D) <CR>	
		MessBus	<STX> D (D) (D) (D) (D) (D) (D) (D) (D) (D) (D) (D) (D) <ETX> <BCC>	
Confirmation of data acceptance (PC) - OK	485	MessBus	<DLE> 1	
Confirmation of data acceptance (PC) - Bad			<NAK>	
Sending address (PC) prior command			<EADR> <ENQ>	
Confirmation of address (instrument)			<SADR> <ENQ>	
Command transmission (PC)	232	ASCII	# A A N P (D) (D) (D) (D) (D) (D) (D) (D) <CR>	
		MessBus	<STX> S N P (D) (D) (D) (D) (D) (D) (D) (D) <ETX> <BCC>	
	485	ASCII	# A A N P (D) (D) (D) (D) (D) (D) (D) (D) <CR>	
		MessBus	<STX> S N P (D) (D) (D) (D) (D) (D) (D) (D) <ETX> <BCC>	
Command confirmation (instrument)	232	ASCII	OK	! A A <CR>
			Bad	? A A <CR>
		Messbus		No - data is transmitted permanently
		485	ASCII	OK
	Bad			? A A <CR>
	MessBus		OK	<DLE> 1
			Bad	<NAK>
	Instrument identification			# A A 1 Y <CR>
HW identification			# A A 1 Z <CR>	
One-time transmission			# A A 7 X <CR>	
Repeated transmission			# A A 8 X <CR>	

LEGEND

SIGN	RANGE	DESCRIPTION
#	35 23 _H	Command beginning
A A	0...31	Two characters of instrument address (sent in ASCII - tens and units, e.g. "01", "99" universal)
<CR>	13 00 _H	Carriage return
<SP>	32 20 _H	Space
N, P		Number and command - command code
D		Data - usually characters "0"... "9", "*", ".", ";", ":", "[] - dp, and {} may prolong data
R	30 _H ...3F _H	Relay and tare status
!	33 21 _H	Positive confirmation of command (ok)
?	63 3F _H	Negative confirmation of command (point)
>	62 3E _H	Beginning of transmitted data
<STX>	2 02 _H	Beginning of text
<ETX>	3 03 _H	End of text
<SADR>	adresa +60 _H	Prompt to send from address
<EADR>	adresa +40 _H	Prompt to accept command at address
<END>	5 05 _H	Terminate address
<DLE>1	16 49 10 _H 31 _H	Confirm correct statement
<NAK>	21 15 _H	Confirm error statement
<BCC>		Check sum -XOR

RELAY, TARE

SIGN	RELAY 1	RELAY 2	TARE	CHANGE RELAY 3/4
P	0	0	0	0
Q	1	0	0	0
R	0	1	0	0
S	1	1	0	0
T	0	0	1	0
U	1	0	1	0
V	0	1	1	0
W	1	1	1	0
p	0	0	0	1
q	1	0	0	1
r	0	1	0	1
s	1	1	0	1
t	0	0	1	1
u	1	0	1	1
v	0	1	1	1
w	1	1	1	1

Relay status is generated by command #AA6X <CR>.

The instrument immediately returns the value in the format >HH <CR>, where HH is value in HEX format and range 00_H...FF_H. The lowest bit stands for „Relay 1“, the highest for „Relay 8“

11. TECHNICAL DATA



INPUT

range is adjustable		DC
±60 mV	>100 MΩ	Input U
±150 mV	>100 MΩ	Input U
±300 mV	>100 MΩ	Input U
±1200 mV	>100 MΩ	Input U

range is adjustable		DC - option "A"
±0,1 A	< 300 mV	Input I
±0,25 A	< 300 mV	Input I
±0,5 A	< 300 mV	Input I
±1 A	< 30 mV	Input I
±5 A	< 150 mV	Input I
±100 V	20 MΩ	Input U
±250 V	20 MΩ	Input U
±500 V	20 MΩ	Input U

range is adjustable		PM
0/4...20 mA	< 400 mV	Input I
±2 V	1 MΩ	Input U
±5 V	1 MΩ	Input U
±10 V	1 MΩ	Input U
±40 V	1 MΩ	Input U

range is adjustable		OHM
0...100 Ω		
0...1 kΩ		
0...10 kΩ		
0...100 kΩ		
Autorange		

Connection:	2, 3 or 4 wire	
Pt xxxx	-200°...850°C	RTD
Pt xxxx/3910 ppm	-200°...1 100°C	
Ni xxxx	-50°...250°C	
Cu/4260 ppm	-50°...200°C	
Cu/4280 ppm	-200°...200°C	
Type Pt:	EU > 100/500/1 000 Ω, with 3 850 ppm/°C US > 100 Ω, with 3 920 ppm/°C RU > 50/100 Ω, with 3 910 ppm/°C	
Type Ni:	Ni 1 000/ Ni 10 000 with 5 000/6 180 ppm/°C	
Type Cu:	Cu 50/Cu 100 with 4 260/4 280 ppm/°C	
Connection:	2, 3 or 4 wire	

range is adjustable in configuration menu		T/C
Type:		
J (Fe-CuNi)	-200°...900°C	
K (NiCr-Ni)	-200°...1 300°C	
T (Cu-CuNi)	-200°...400°C	
E (NiCr-CuNi)	-200°...690°C	
B (PtRh30-PtRh6)	300°...1 820°C	
S (PtRh10-Pt)	-50°...1 760°C	
R (Pt13Rh-Pt)	-50°...1 740°C	
N (Omega alloy)	-200°...1 300°C	
L (Fe-CuNi)	-200°...900°C	

Voltage of lin. pot.	2,5 VDC/6 mA	DU
	min. potentiometer resistance is 500 Ω	

PROJECTION

Display:	24-segment 3-color bargraph red/green/orange
Auxiliary display	999, intensive red or green 7 segment LED, digit height 9,1mm 24 LED/99...999
Projection:	adjustable - in menu
Decimal point:	adjustable - in menu
Brightness:	adjustable - in menu

INSTRUMENT ACCURACY

TC:	50 ppm/°C	
Accuracy:	±0,1% of range + 1 digit ±0,15% of range + 1 digit	RTD, T/C
Resolution:	0,01%/0,1%/*	RTD
Rate:	0,1...40 measurements/s**	
Overload capacity:	10x [t < 100 ms] not for 500 V and 5 A, 2x [long-term]	
Linearisation:	by linear interpolation in 38 points - solely via QM Link	
Digital filters:	Averaging, Floating average, Exponential filter, Rounding	
Comp. of conduct:	max. 40 Ω/100 Ω	RTD
Comp. of cold junc.:	adjustable	T/C
Functions:	0°...99°C or automatic Tare - display resetting Hold - stop measuring (at contact) Lock - control key locking MM - min/max value Mathematic functions	
QM Link:	company communication interface for setting, operation and update of instrument SW	
Watch-dog:	reset after 400 ms	
Calibration:	at 25°C and 40% of r.h.	

COMPARATOR

Type:	digital, adjustable in menu
Mode:	Hysteresis, Fros, Dosing
Limits:	-99...999
Hysteresis:	0...999999
Delay:	0...99,9 s
Outputs:	2x relays with switch-on contact [Form A] (230 VAC/30 VDC, 3 A)* 2x relays with switch-off contact [Form C] (230 VAC/50 VDC, 3 A)* 2x SSR (250 VAC/ 1 A)* 2x/4x open NPN collector (30 VDC/100 mA) 2x bistabil relays [250 VAC/250 VDC, 3 A/0,3 A]* 1/8 HP 277 VAC, 1/10 HP 125 V, Pilot Duty D300
Relay:	

* values apply for resistance load

DATA OUTPUTS

Protocols:	ASCII, DIN MessBus, MODBUS, PROBUS
Data format:	8 bit + no parity + 1 stop bit (ASCII) 7 bit + even parity + 1 stop bit (MessBus)
Rate:	600...230 400 Baud 9 600 Baud...12 Mbaud (PROFIBUS)
RS 232:	isolated, two-way communication
RS 485:	isolated, two-way communication, addressing (max. 31 instruments)
PROFIBUS	Data protocol SIEMENS

ANALOG OUTPUTS

Type:	isolated, programmable with 16 bits Q/A converter, analog output corresponds with displayed data, type and range are adjustable
Non-linearity:	0,1% of range
TC:	15 ppm/°C
Rate:	response to change of value < 1 ms
Voltage:	0...2 V/5 V/10 V/±10 V
Current:	0...5/20 mA/4...20 mA - compensation of conduct to 500 Ω/12 V or 1 000 Ω/24 V

MEASURED DATA RECORD

Type RTC:	time-controlled logging of measured data into instrument memory, allows to log up to 250 000 values
Type FAST:	fast data logging into instrument memory, allows to log up to 8 000 values at a rate of 40 records/s
Transmission:	via data output RS 232/485 or via QM Link

EXCITATION

Adjustbale:	5...24 VDC/max. 1,2 W, isolated
-------------	---------------------------------

POWER SUPPLY

Options:	10...30 V AC/DC, max. 13,5 VA, PF ≥ 0,4, $I_{LTP} < 40 \text{ A/1 ms}$, isolated - fuse inside (T 4000 mA)
	80...250 V AC/DC, max. 13,5 VA, PF ≥ 0,4, $I_{LTP} < 40 \text{ A/1 ms}$, isolated - fuse inside (T 630 mA)

MECHANIC PROPERTIES

Material:	Noryl GFN2 SE1, incombustible UL 94 V-1
Dimensions:	48 x 96 x 120 mm
Panel cut-out:	45 x 90,5 mm

OPERATING CONDITIONS

Connection:	connector terminal board, conductor cross-section <1,5 mm ² / <2,5 mm ²
Stabilisation period:	within 15 minutes after switch-on
Working temp.:	-20°...60°C
Storage temp.:	-20°...85°C
Cover:	IP64 (front panel only)
Construction:	safety class I
Dielectric strength:	4 kVAC after 1 min between supply and input 4 kVAC after 1 min between supply and data/ analog output 4 kVAC after 1 min between supply and relay output 2,5 kVAC after 1 min between supply and data/ analog output
Overvoltage cat.:	EN 61010-1, A2
Insulation resist.:	for pollution degree II, measurement cat. III instrum.power supply > 670 V (PI), 300 V (DI) Input/output > 300 V (PI), 150 (DI)
EMC:	EN 61326-1
Seismic resistance:	IEC 980: 1993, par. 6

**Table of rate of measurement in relation to number of inputs

Channels/Rate	40	20	10	5	2	1	0,5	0,2	0,1
No.of channels: 1 [Type: DC, PM, DU]	40,00	20,00	10,00	5,00	2,00	1,00	0,50	0,20	0,10
No.of channels: 2	5,00	2,50	1,25	1,00	0,62	0,38	0,22	0,09	0,05
No.of channels: 3	3,33	1,66	0,83	0,66	0,42	0,26	0,14	0,06	0,03
No.of channels: 4	2,50	1,25	0,62	0,50	0,31	0,19	0,11	0,05	0,02
No.of channels: 1 [Type: OHM, RTD, T/C]	5,00	2,50	1,25	1,00	0,62	0,38	0,22	0,09	0,05
No.of channels: 2	3,33	1,066	0,83	0,66	0,42	0,26	0,14	0,06	0,03
No.of channels: 3	2,50	1,25	0,62	0,50	0,31	0,19	0,11	0,05	0,02
No.of channels: 4	2,00	1,00	0,50	0,40	0,25	0,15	0,08	0,04	0,02

13. INSTRUMENT DIMENSIONS AND INSTALLATION



Front view

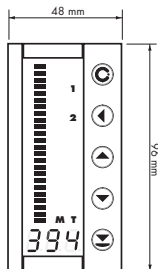

Side view

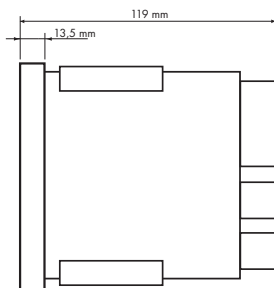

Panel cut

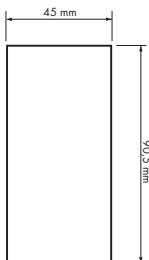

Panel thickness: 0.5 - 2.0 mm

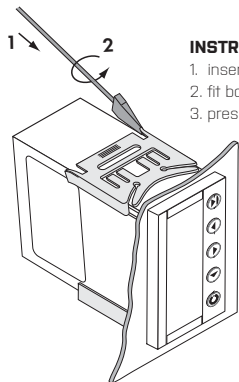

INSTRUMENT INSTALLATION

1. insert the instrument into the panel cut-out
2. fit both travellers on the box
3. press the travellers close to the panel

INSTRUMENT DISASSEMBLY

1. slide a screw driver under the traveller wing
2. turn the screw driver and remove the traveller
3. take the instrument out of the panel

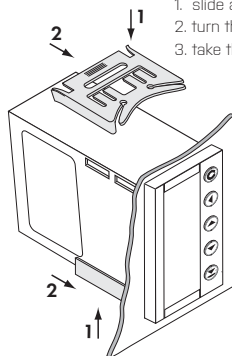



Product **OMB 412UNI**
Type
Manufacturing No.
Date of sale

A

GUARANTEE

A guarantee period of 60 months from the date of sale to the user applies to this instrument.
Defects occurring during this period due to manufacture error or due to material faults shall be eliminated free of charge.

For quality, function and construction of the instrument the guarantee shall apply provided that the instrument was connected and used in compliance with the instructions for use.

The guarantee shall not apply to defects caused by:

- mechanic damage
- transportation
- intervention of unqualified person incl. the user
- unavoidable event
- other unprofessional interventions

The manufacturer performs guarantee and post.guarantee repairs unless provided for otherwise.

Y E A R S

Stamp, signature



Company: **ORBIT MERRET, spol. s r.o.**
Klánova 81/141, 142 00 Prague 4, Czech Republic, IDNo.: 00551309

Manufactured: **ORBIT MERRET, spol. s r.o.**
Vodňanská 675/30, 198 00 Prague 9, Czech Republic

declares at its explicit responsibility that the product presented hereunder meets all technical requirements, is safe for use when utilised under the terms and conditions determined by ORBIT MERRET, spol.s r.o. and that our company has taken all measures to ensure conformity of all products of the types referred-to hereunder, which are being brought out to the market, with technical documentation and requirements of the appurtenant Czech statutory orders.

Product: Programmable panel instrument

Type **DMB 412**

Version: UNI, UQC, PWR, RS

That has been designed and manufactured in line with requirements of:

Statutory order no. 17/2003 Coll., on low-voltage electrical equipment (directive no. 73/23/EHS)
Statutory order no. 616/2006 Coll., on electromagnetic compatibility (directive no. 2004/108/EHS)

The product qualities are in conformity with harmonized standard:

El. safety: EN 61010-1

EMC: EN 61326-1

Electronic measuring, control and laboratory devices – Requirements for EMC "Industrial use"
EN 50131-1, chap. 14 and chap. 15, EN 50130-4, chap. 7, EN 50130-4, chap. 8, [EN 61000-4-11, ed. 2],
EN 50130-4, chap. 9 [EN 61000-4-2], EN 50130-4, chap. 10, [EN 61000-4-3, ed. 2], EN 50130-4, chap. 11 [EN 61000-4-6],
EN 50130-4, chap. 12, [EN 61000-4-4, ed. 2], EN 50130-4, chap. 13 [EN 61000-4-5], EN 61000-4-8, EN 61000-4-9,
EN 61000-6-1, EN 61000-6-2, EN 65022, chap. 5 and chap. 6

Seismic resistance: IEC 980: 1993, par. 6

The product is furnished with CE label issued in 2007

As documentation serve the protocols of authorized and accredited organizations:

EMC MD CR, Testing institute of technical devices, protocol no. 80/6-328/2006 of 15/01/2007

EMC MD CR, Testing institute of technical devices, protocol no. EMI.80/6-333/2006 of 15/01/2007

Seismic resistance VOP-026 Stemberk, protocol no.: 6430-109/2007 of 13/09/2007

Place and date of issue: Prague, 19. Juli 2010

Miroslav Hackl
Company representative

Assessment of conformity pursuant to §22 of Act no. 22/1997 Coll. and changes as amended by Act no.71/2000 Coll. and 205/2002 Coll