



OMD 202RS

**4/6 DIGIT PROGRAMMABLE
LARGE DISPLAY**

DATA DISPLAY

RS 232/485

ASCII/MESSBUS/PROFIBUS





SAFETY INSTRUCTIONS

Please, read the enclosed safety instructions carefully and observe them!
These instruments should be safeguarded by isolated or common fuses (breakers)!
For safety information the EN 61 010-1 + A2 standard must be observed.
This instrument is not explosion-safe!

TECHNICAL DATA

Measuring instruments of the OMD 202 series conform to the European regulation No. 73/23/EHS and No. 2004/109/EC.

They are up to the following European:
EN 61010-1 Electrical safety
EN 61326-1 Electrical measurement, EMC standards „Industrial use“

The instruments are applicable for unlimited use in agricultural and industrial areas.

CONNECTION

Supply of energy from the main line has to be isolated from the measuring leads.

ORBIT MERRET, spol. s r.o.

Vodňanská 675/30
198 00 Praha 9
Czech Republic

Tel: +420 - 281 040 200
Fax: +420 - 281 040 299
e-mail: orbit@merret.cz
www.orbit.merret.cz





1. CONTENTS	3	6.4.3 Restoration manufacture setting	75
2. INSTRUMENT DESCRIPTION	4	6.4.4 Selection of instrument menu language version	76
3. INSTRUMENT CONNECTION	6	6.4.5 Setting new access password	76
Instrument connection	7	6.4.6 Instrument identification	76
4. INSTRUMENT SETTING	8	7. SETTING ITEMS INTO "USER" MENU	78
User data format	9	7.0 Configuration "USER" menu	78
Symbols used in the instructions	10	8. DATA PROTOCOL	80
Setting the DP and the () sign	10	9. ERROR STATEMENTS	82
Control keys function	11	10. TABLE OF SYMBOLS	83
Setting/permitting items into "USER" menu	11	11. TECHNICAL DATA	84
5. SETTING "LIGHT" MENU	12	12. INSTRUMENT DIMENSIONS AND INSTALATION . . .	86
5.0 Description "LIGHT" menu	12	13. CERTIFICATE OF GUARANTEE	87
Entering the menu	14		
Setting Baud, addresse and protocol	14		
Setting the user data format	22		
Setting Limits	32		
Setting analog output	34		
Setting display colors	36		
Setting the address of IR remote control	38		
Selection of programming menu „LIGHT"/„PROFI" ..	38		
Restoration of manufacture setting	39		
Selection of instrument menu language version ..	39		
Setting new access password	40		
Instrument identification	40		
6. SETTING "PROFI" MENU	42		
6.0 Description of "PROFI" menu	42		
6.1 "PROFI" menu - INPUT			
6.1.1 Resetting internal values	46		
6.1.2 Configuring the instrument	47		
6.1.3 External input function selection	55		
6.1.4 Optional accessory functions of the keys ..	56		
6.2 "PROFI" menu - CHANNEL			
6.2.1 Setting measuring parameters	60		
6.2.2 Setting mathematic functions	63		
6.2.3 Selection of evaluation of min/max. value ..	65		
6.3 "PROFI" menu - OUTPUT			
6.3.1 Setting Limits	66		
6.3.2 Setting analog output	70		
6.3.3 Selection of display projection	71		
6.4 "PROFI" menu - SERVICE			
6.4.1 Setting the address of IR remote control . .	74		
6.4.2 Selection of programming menu „LIGHT"/„PROFI"	75		

2. INSTRUMENT DESCRIPTION



2.1 DESCRIPTION

The OMD 202 model series are 4/6 digit large panel programmable displays for the projection of data from data lines RS 232, RS 485 in protocols ASCII/MESSBUS/MODBUS/PROFIBUS. The instrument can be supplied with either a 3-colour LED display (red/green/orange) or with high intensity SMD LEDs (red or green with brightness of 1300 mcd).

The instrument is based on an 8-bit microcontroller, which secures high accuracy, stability and easy operation of the instrument.

PROGRAMMABLE PROJECTION

Setting:	Selection of integer/float input range
Protocol:	ASCII/MESSBUS MODBUS - RTU PROFIBUS DP*
Projection:	-9999...9999 [-99999...999999]

DIGITAL FILTERS

Floating average:	from 2...30 measurements
Exponential average:	from 2...100 measurements
Arithmetic average:	from 2...100 measurements
Rounding:	setting the projection step for display

MATHEMATIC FUCTIONS

Min/max. value:	registration of min./max. value reached during measurement
Tare:	designed to reset display upon non-zero input signal
Peak value:	the display shows only max. or min. value
Mat. operations:	polynome, $1/x$, logarithm, exponential, power, root, sin x

EXTERNAL CONTROL

Lock:	control keys blocking
Hold:	display/instrument blocking
Tare:	tare activation/resetting tare to zero
Resetting MM:	resetting min/max value

* description is presented in a separate manual

2.2 OPERATION

The instrument is set and controlled by IR Remote control. All programmable settings of the instrument are performed in three adjusting modes:

LIGHT	Simple programming menu - contains solely items necessary for instrument setting and is protected by optional number code
PROFI	Complete programming menu - contains complete instrument menu and is protected by optional number code
USER	User programming menu - may contain arbitrary items selected from the programming menu (LIGHT/PROFI), which determine the right (see or change) - acces without password

All programmable parameters are stored in the EEPROM memory (they hold even after the instrument is switched off).

OMLINK Complete instrument operation and setting may be performed via DM Link communication interface, which is a standard equipment of all instruments.

The operation program is freely accessible (www.orbit.merret.cz) and the only requirement is the purchase of OML cable to connect the instrument to PC. It is manufactured in version RS 232 and USB and is compatible with all ORBIT MERRET instruments. Another option for connection is with the aid of data output RS 232 or RS 485 (without the need of the OML cable).

The program OMLINK in „Basic“ version will enable you to connect one instrument with the option of visualization and archiving in PC. The OMLINK „Standard“ version has no limitation of the number of instruments connected.

2.3 OPTIONS

Excitation is suitable for supplying power to sensors and transmitters.

Comparators are assigned to monitor one, two, three or four limit values with relay output. The user may select limits regime: LIMIT/DOSING/FROM-TO. The limits have adjustable hysteresis within the full range of the display as well as selectable delay of the switch-on in the range of 0...99,9 s. Reaching the preset limits is signalled by LED and simultaneously by the switch-on of the relevant relay.

Analog outputs will find their place in applications where further evaluating or processing of measured data is required in external devices. We offer universal analog output with the option of selection of the type of output - voltage/current. The value of analog output corresponds with the displayed data and its type and range are selectable in Menu.

3. INSTRUMENT CONNECTION



The instrument supply leads should not be in proximity of the incoming low-potential signals.

Contactors, motors with larger input power should not be in proximity of the instrument.

The leads into the instrument input (measured quantity) should be in sufficient distance from all power leads and appliances. Provided this cannot be secured it is necessary to use shielded leads with connection to ground (bracket E).

The instruments are tested in compliance with standards for use in industrial area, yet we recommend to abide by the above mentioned principles.

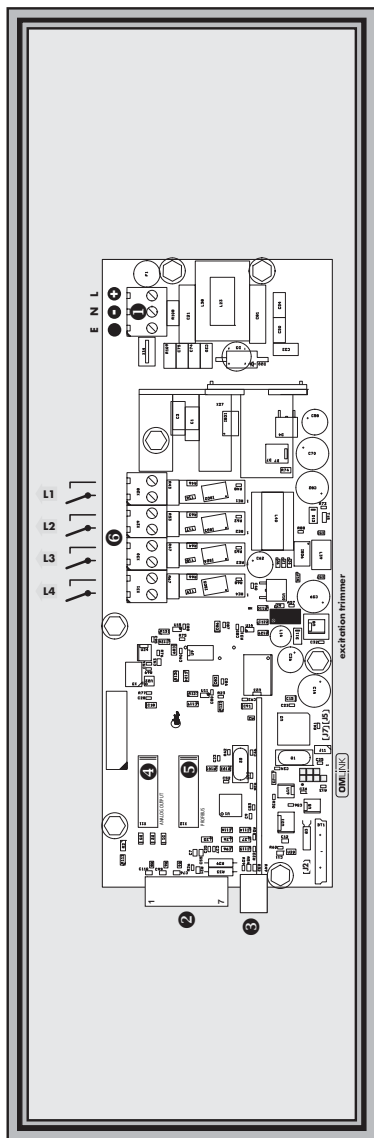

1 Power supply

4 Analog output*

5 Input - PROFIBUS*

6 Relays*

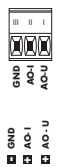

- 0 - Positive
- 1 - Negative
- GND

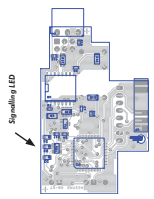

3 Input



2 Input



Jumpers

- J2 back-up battery
- J5 hardware test
- J7 "cold" load of instrument's FW

*Option



SETTING **PROFI**

For expert users

Complete instrument menu

Access is password protected

Possibility to arrange items of the **USER MENU**

Tree menu structure

SETTING **LIGHT**

For trained users

Only items necessary for instrument setting

Access is password protected

Possibility to arrange items of the **USER MENU**

Linear menu structure

SETTING **USER**

For user operation

Menu items are set by the user (Profi/Light) as per request

Access is not password protected

Optional menu structure either tree (PROFI) or linear (LIGHT)

4.1 SETTING

The instrument is set and controlled by IR Remote control. All programmable settings of the instrument are performed in three adjusting modes::

- LIGHT** **Simple programming menu**
 - contains solely items necessary for instrument setting and is protected by optional number code
- PROFI** **Complete programming menu**
 - contains complete instrument menu and is protected by optional number code
- USER** **User programming menu**
 - may contain arbitrary items selected from the programming menu (LIGHT/PROFI), which determine the right (see or change)
 - acces without password

Complete instrument operation and setting may be performed via OML Link communication interface, which is a standard equipment of all instruments.

The operation program is freely accessible (www.orbit.merret.cz) and the only requirement is the purchase of OML cable to connect the instrument to PC. It is manufactured in version RS 232 and USB and is compatible with all ORBIT MERRET instruments.

Another option for connection is with the aid of data output RS 232 or RS 485 (without the need of the OML cable).

User data protocol

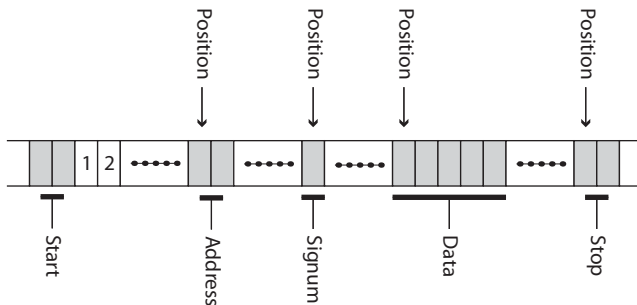

6. INSTRUMENT SETTING

Setting and controlling the instrument is performed by means of the Remote control. With the aid of the Remote control it is possible to browse through the operation menu and to select and set the required values.

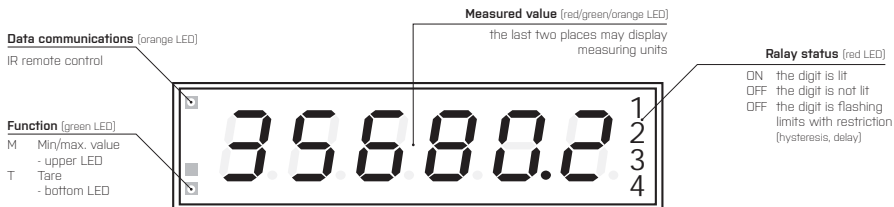

Symbols used in the instructions

- DEF** values preset from manufacture
- symbol indicates a flashing light (symbol)
- MIN** inverted triangle indicates the item that can be placed in USER menu
- U.M.L1** broken line indicates a dynamic item, i.e. it is displayed only in particular selection/version
- after pressing the key the set value will not be stored
- after pressing the key the set value will be stored
- 30** continues on page 30

Setting the decimal point and the minus sign











DECIMAL POINT

Its selection in the menu, upon modification of the number to be adjusted it is performed by the control key with transition beyond the highest decade, when the decimal point starts flashing. Positioning is performed by .

THE MINUS SIGN

Setting the minus sign is performed by the key on higher decade. When editing the item subtraction must be made from the current number [e.g.: 013 > , on class 100 > -87]

Control keys functions

KEY	MEASUREMENT	MENU	SETTING NUMBERS/SELECTION
	access into USER menu	exit menu	quit editing
	programmable key function	back to previous level	move to higher decade*
	programmable key function	move to previous item	move down*
	programmable key function	move to next item	move up*
	programmable key function	confirm selection	confirm setting/selection
	access into LIGHT/PROFI menu		
	direct access into PROFI menu		
		configuration of an item for "USER" menu	
		determine the sequence of items in "USER - LIGHT" menu	
	cancellation of instrument's/controller's address		

* alternatively, the setting may be done from the numeric keys of the remote control by selecting directly the number required

Setting items into „USER“ menu

- in **LIGHT** or **PROFI** menu
- no items permitted in **USER** menu from manufacture
- on items marked by inverted triangle

USER

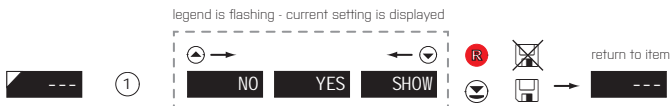

- NO** item will not be displayed in USER menu
- YES** item will be displayed in USER menu with the option of setting
- SHOW** item will be solely displayed in USER menu



SETTING LIGHT

For trained users

Only items necessary for instrument setting

Access is password protected

Possibility to arrange items of the **USER MENU**

Linear menu structure

Preset from manufacture

Password	"0"
Menu	LIGHT
USER menu	off
Setting the items	DEF

!

Upon delay exceeding 60 s the programming mode is automatically discontinued and the instrument itself restores the measuring mode

Access password

1428 **PASSW** 0

Baud rate: **BAUD** 9600 Instrument address: **ADDR** 0 Data protocol: **PROT** ASQ1 Command: **COMMA** 0

Setting - Integer: **MI N.0** 0 **MI N.1** 0 **MI N.2** 0 **MI N.3** 0

Setting - Integer: **MAX.0** 0 **MAX.1** 0 **MAX.2** 0 **MAX.3** 100

Setting - Float: **MI N.9F** 000.00 **MAX.9F** 100.00

Setting - 1. initial sequence: **START1** 2 Setting - 2. initial sequence: **START2** 0 Setting - Address position: **AD.POS** 0 Setting - 1. address symbol: **Adr.1** 48

Setting - 2. address symbol: **ADR2** 49 Setting - Signum position: **SI.POS** 0 Signum suppression: **PL.SUP** YES Setting - Data position: **DA.POS** 0

Setting - closing sequence: **STOP** STOP 1 Setting - Request (REQ.1..REQ.8): **REQUEST** REQ.1 Setting - Communi. failure: **MOD.TD** DASHES Setting - Timeout: **TI.MEOU** 10

Selection input range - min: **MI N.A** 0000.00 Selection input range - max: **MAX.A** 100.00 Projection: **FORM.A** 0000.o.o

Option - comparator: **UM.L1** 20 **UM.L2** 40 **UM.L3** 60 **UM.L4** 80

Option - Analog output: **TYP.AO** I 20 **MI N.A.O.** 0 **MAX.A.O.** 100

Primary color: **COL.0** GREEN First color limit: **DI S.L1** 33.33 Color beyond first limit: **COL.1** ORANGE Second color limit: **DI S.L2** 66.67

Color beyond second limit: **COL.2** RED Menu type: **MENU** U GHT Return to manufacture setting: **RE.SET** FIRM Language selection: **LANG.** ENGL

New password: **PAS.U** 0 Identification: **IDENT.** YES Instrument type: **OMD202RS** SW number: **78** 1428 Return to measuring mode

5. SETTING LIGHT

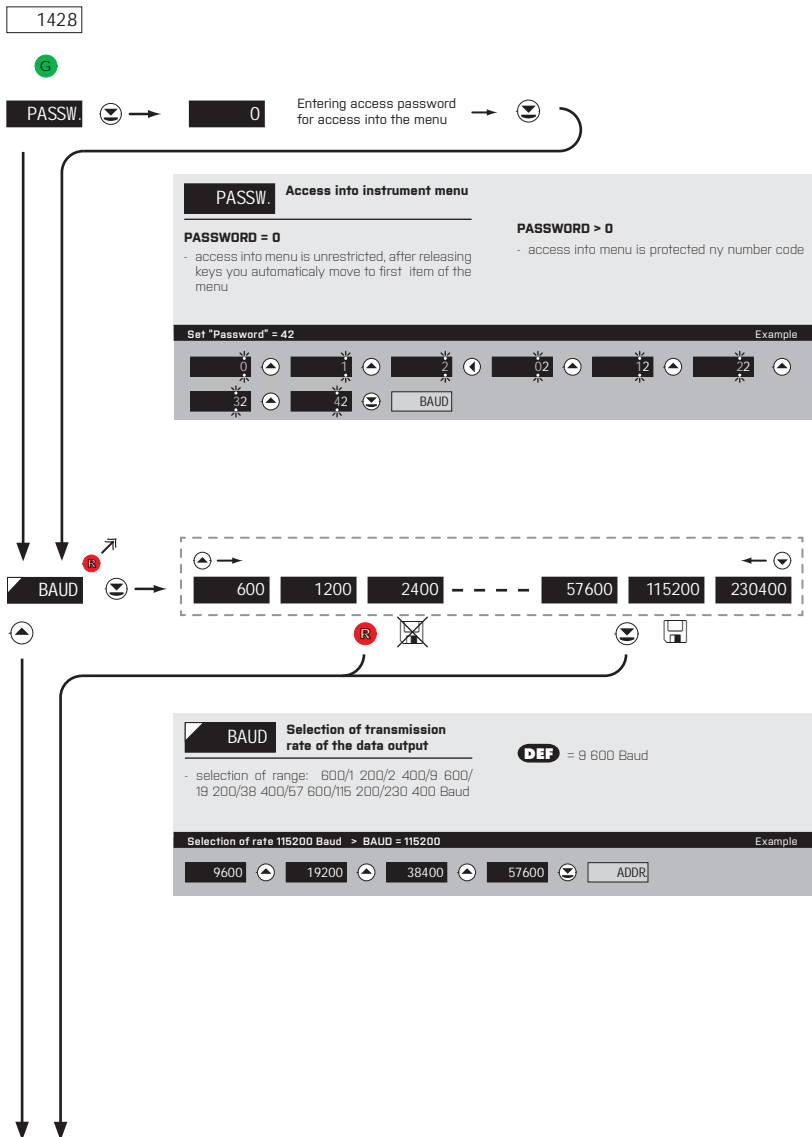

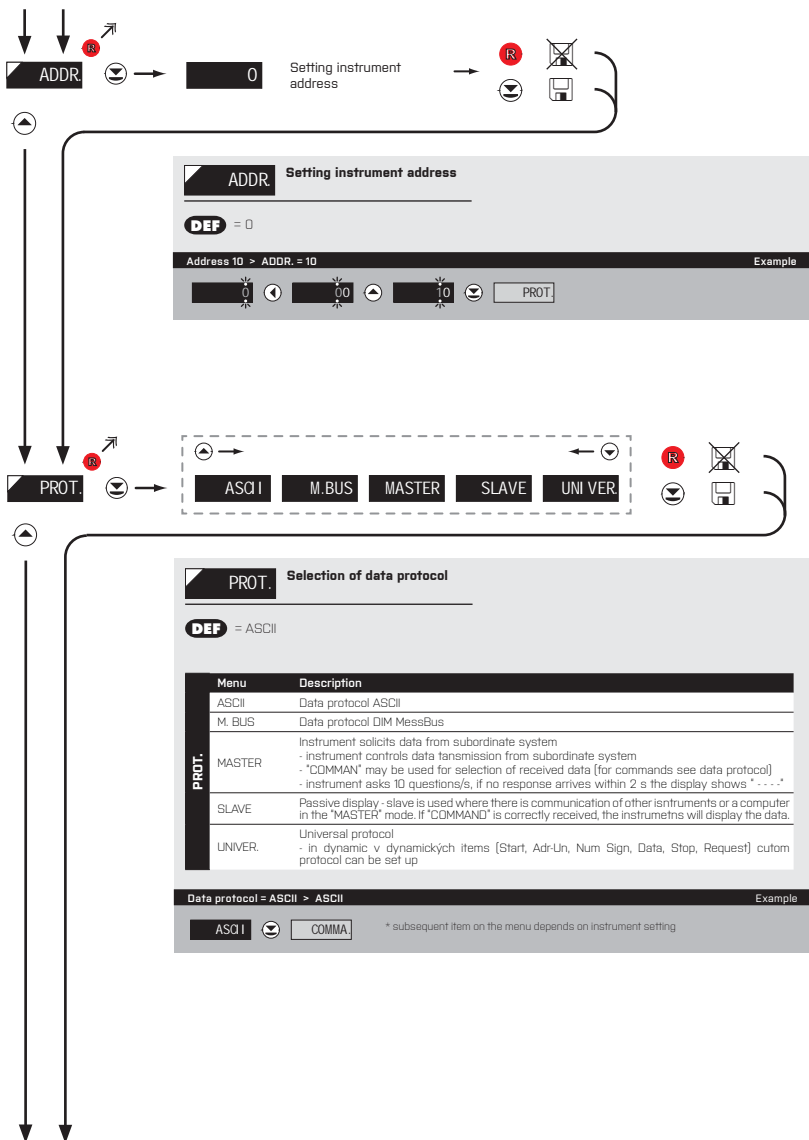

5. SETTING LIGHT

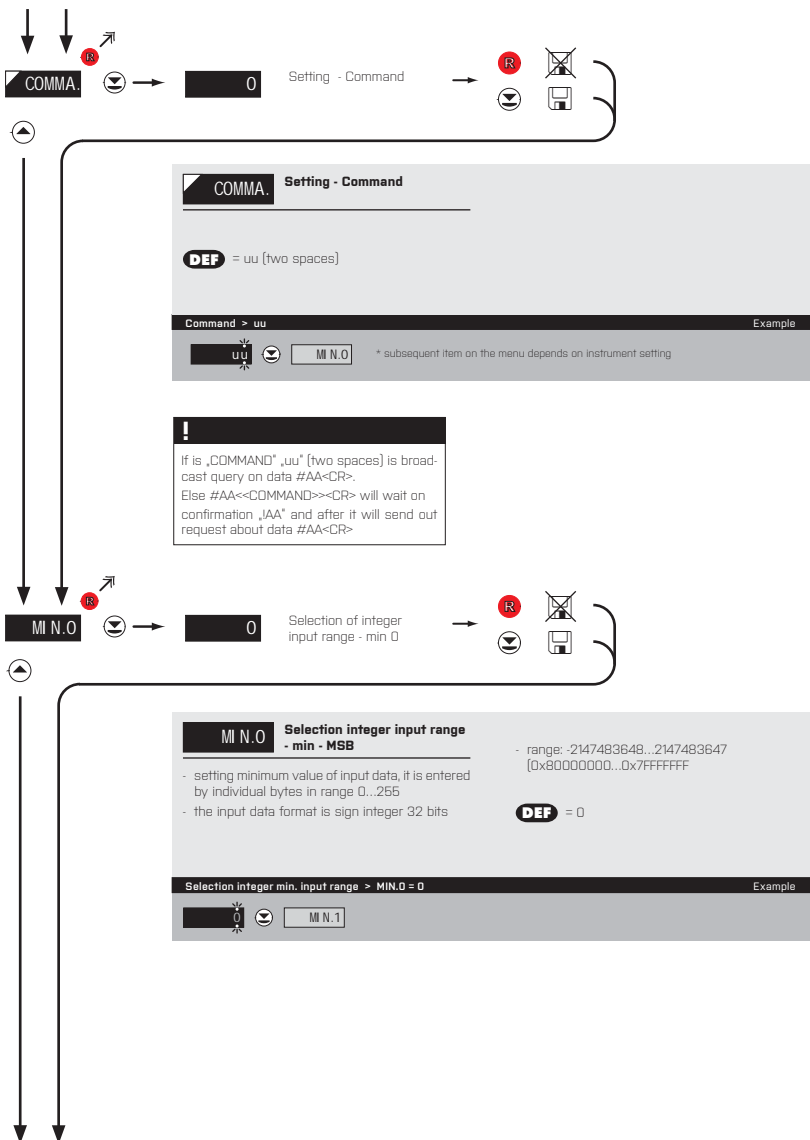

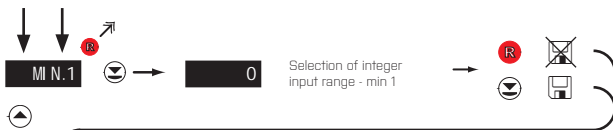

MI N.1 Selection of integer input range - min

- range: -2147483648...2147483647 [0x80000000...0x7FFFFFFF]
- setting minimum value of input data, it is entered by individual bytes in range 0...255
- the input data format is sign integer 32 bits

DEF = 0

Selection integer min. input range > MIN.1 = 0 Example

MI N.2

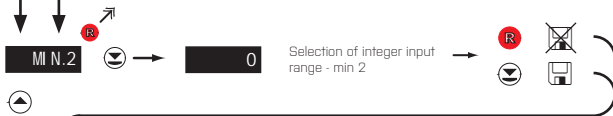

MI N.2 Selection of integer input range - min

- range: -2147483648...2147483647 [0x80000000...0x7FFFFFFF]
- setting minimum value of input data, it is entered by individual bytes in range 0...255
- the input data format is sign integer 32 bits

DEF = 0

Selection integer min. input range > MIN.2 = 0 Example

MI N.3

5. SETTING LIGHT

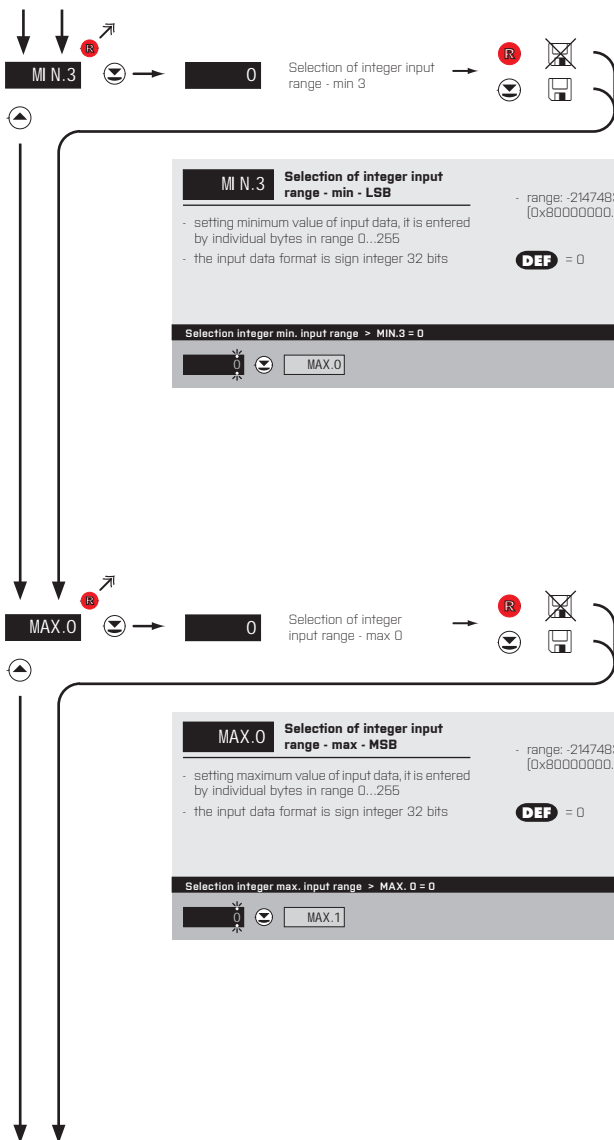



MAX.1 Selection of integer input range - max

- range: -2147483648...2147483647 [0x80000000...0x7FFFFFFF]
- setting maximum value of input data, if is entered by individual bytes in range 0...255
- the input data format is sign integer 32 bits

DEF = 0

Selection integer max. input range > MAX.1 = 0 Example



MAX.2 Selection of integer input range - max

- range: -2147483648...2147483647 [0x80000000...0x7FFFFFFF]
- setting maximum value of input data, it is entered by individual bytes in range 0...255
- the input data format is sign integer 32 bits

DEF = 0

Selection integer max. input range > MAX.2 = 0 Example

5. SETTING LIGHT

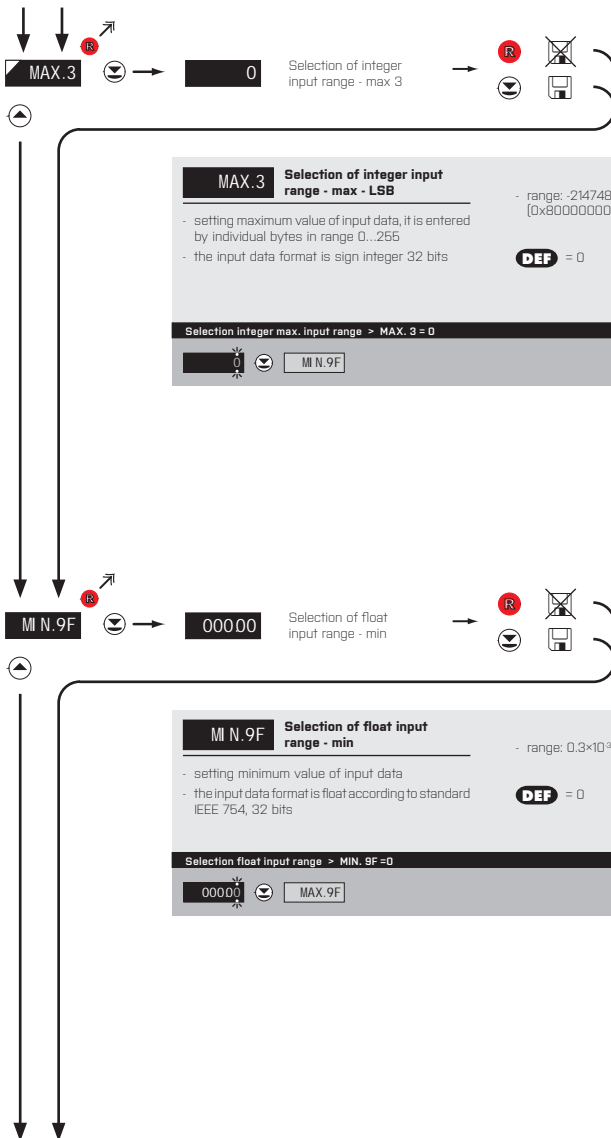

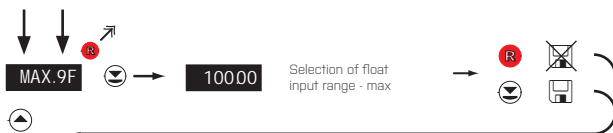

MAX.9F Selection of float input range - max

- setting maximum value of input data
- the input data format is float according to standard IEEE 754, 32 bits
- range: $0.3 \times 10^{30} \leq |x| \leq 1.7 \times 10^{30}$

DEF = 100

Selection float input range > MAX.9F=100 Example

10000 MOD.T0 * subsequent item on the menu depends on instrument setting

5. SETTING LIGHT

SETTING > UNIVERSAL PROTOCOL

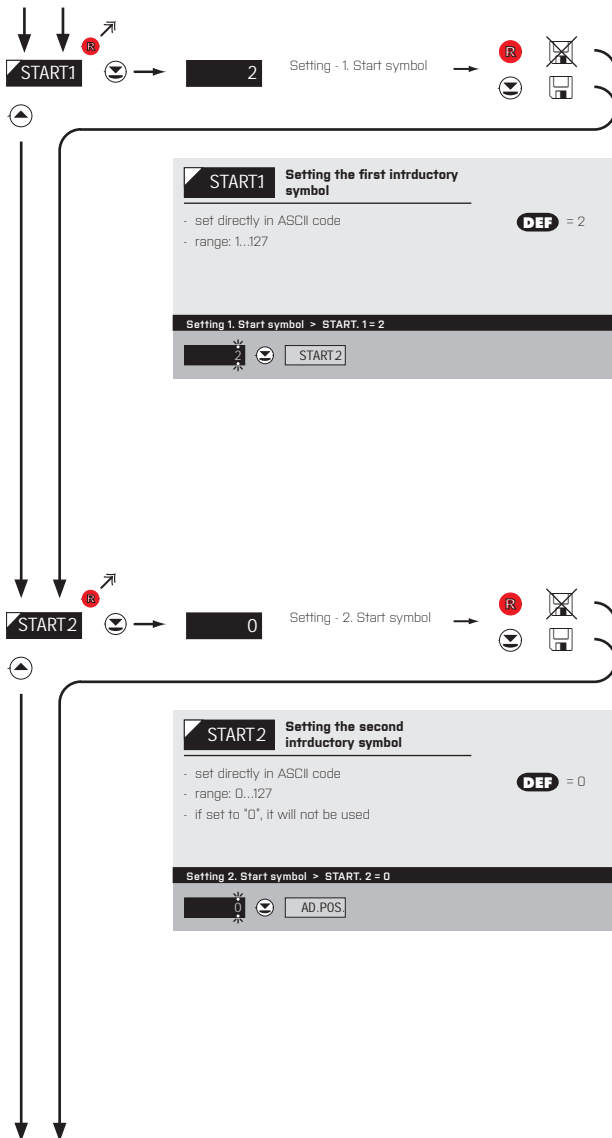

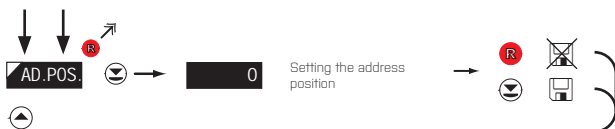

AD.POS. **Setting the address position**

- Position of the address and other symbols which have to have a set value. If set to „0“, the block will not be taken into account. The block can be anywhere in the message
- rozsah: 0..245

DEF = 0

Setting address position > Ad. POS. = 0 Example

0 (crossed square) (floppy disk) ADR.1

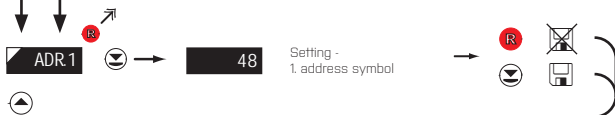

Adr.1 **First address symbol**

- set directly in ASCII code
- range: 0..127

DEF = 48

Setting 1. address symbol > Adr.1 = 48 Example

48 (crossed square) (floppy disk) ADR.2

5. SETTING LIGHT

SETTING > UNIVERSAL PROTOCOL

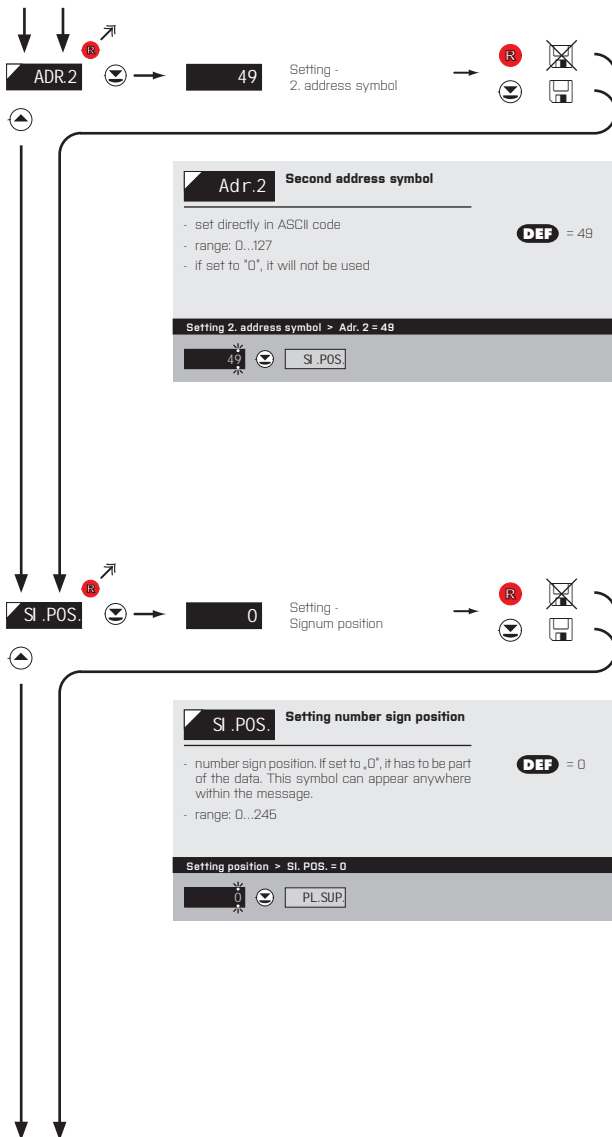

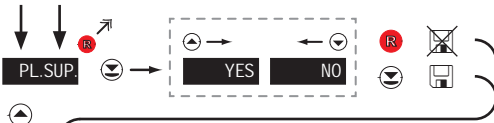

PL_SUP. „Plus“ number sign suppression

- option "YES" > number sign "plus" will be replaced by space
- option "NO" > number sign "plus" will be displayed

DEF = YES

Sign suppression > PL_SUP. = YES Example

YES DA_POS



DA_POS. Setting data position

- Data position. This block can be anywhere within the message. If ending sequence is received sooner than the set number of symbols, it is considered a successful reception.
- range: 1..245

DEF = 1

Setting data position > dA_POS. = 0 Example

DA_LEN

5. SETTING LIGHT

SETTING > UNIVERSAL PROTOCOL

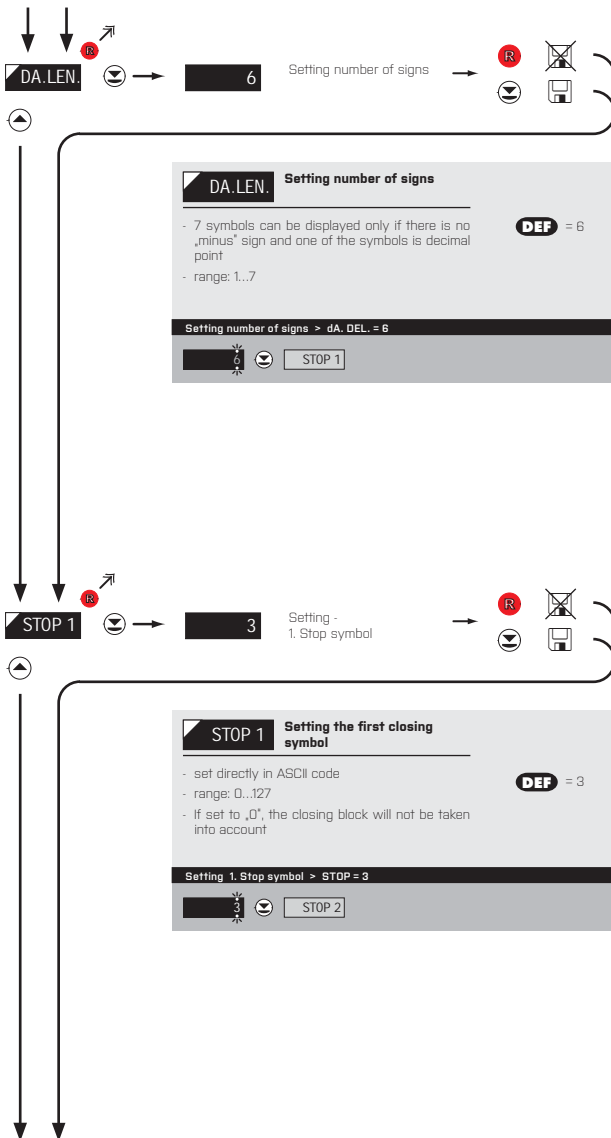



STOP 2 **Setting the second closing symbol**

- set directly in ASCII code
- range: 0..127
- If set to „0“, the block will not be taken into account

DEF = 0

Setting - 2. Stop symbol > STOP 2 = 0 Example

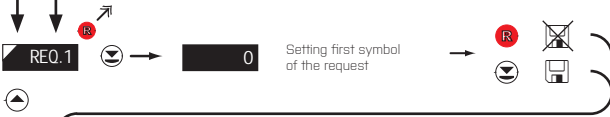

REQ.1 **First symbol of the request**

- set directly in ASCII code
- range: 0..127
- If set to „0“, request is not sent

DEF = 0

Setting - 1. symbol > START.1 = 2 Example

*
Same procedure for REQ. 2..REQ. 8

5. SETTING LIGHT

MOD.T.O. NO BLANK FLASH DASHES DOT

MOD.T.O. Selecting display mode in case of communication failure

DEF = DASHES

Menu	Description
NO	No reaction
BLANK	Display goes off
FLASH	Last displayed value starts flashing
DASHES	Dash symbols displayed
DOT	Decimal point is displayed

Select mode > Dashes Example

DASHES TI.MEOU

! Item will not appear in "MASTER" protocol

TI.MEOU. 6 Setting - Timeout constant

TI.MEOU. Setting the time constant for Timeout

- setting the time delay after which the indication of interrupted communication will appear on the display in the mode of "Mod. t.o."
- range: 0...99,9 s

DEF = 1.0 s

Setting - Constant > #IMEOU.=1 Example

1.0 FORM.A

! Item will not appear in "MASTER" protocol and when "MOD t.o." is disabled

32



MIN A Selection of integer input range - min

- range of the setting is -99999...999999
- position of the DP does not affect display projection
- the DP is automatically shifted after the value is confirmed

DEF = 0.00

Projection for min > MIN A = 0.00 Example

00000

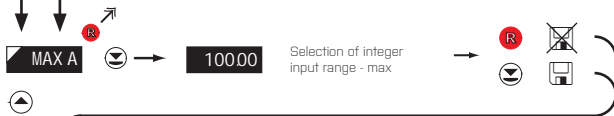

MAX A Selection of integer input range - max

- range of the setting is -99999...999999
- position of the DP does not affect display projection
- the DP is automatically shifted after the value is confirmed

DEF = 100.00

Projection for max > MAX A = 100.00 Example

10000

5. SETTING LIGHT

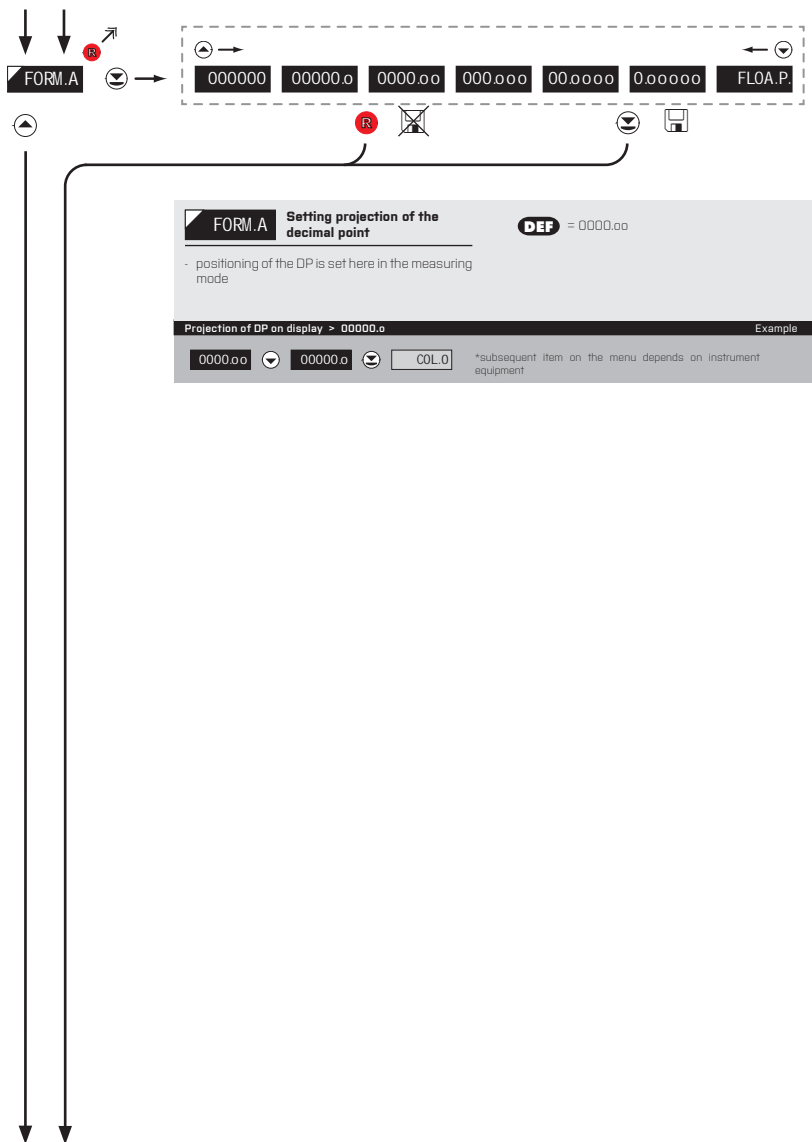



5. SETTING LIGHT

DISPLAYED ONLY WITH OPTIONS > COMPARATORS

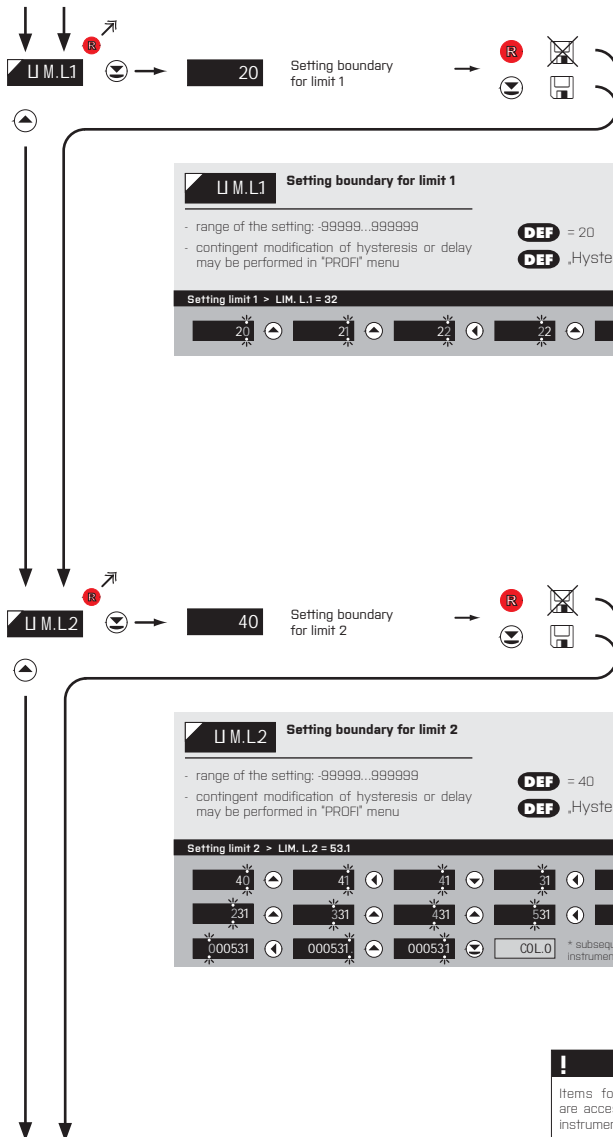

!
Items for "Limits" and "Analog output" are accessible only if incorporated in the instrument.

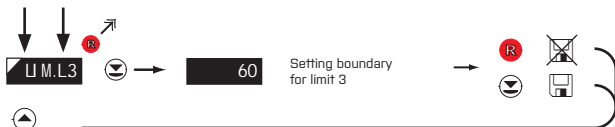

U.M.L.3 **Setting boundary for limit 3**

- range of the setting: -99999...999999
- contingent modification of hysteresis or delay may be performed in "PROF" menu

DEF = 60
DEF „Hysteresis“=0, „Delay“=0

Setting limit 3 > LIM. L.3 = 85 Example

63	61	62	64	65
65	75	85	COL.0	

* subsequent item on the menu depends on instrument equipment

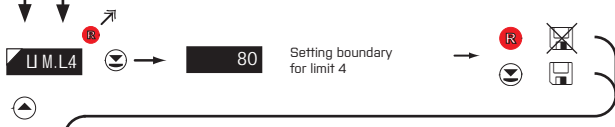

U.M.L.4 **Setting boundary for limit 4**

- range of the setting: -99999...999999
- contingent modification of hysteresis or delay may be performed in "PROF" menu

DEF = 80
DEF „Hysteresis“=0, „Delay“=0

Setting limit 4 > LIM. L.4 = 103 Example

80	81	82	83	93
03	003	103	COL.0	

* subsequent item on the menu depends on instrument equipment

5. SETTING LIGHT

DISPLAYED ONLY WITH OPTIONS > ANALOG OUTPUT

TYP.A.O. Setting the type of analog output

Menu	Range	Description
0-20mA	0...20 mA	
Er4-T	4...20 mA	signaling interrupted current loop and displaying an error message (< 3.0 mA)
4-20T	4...20 mA	signaling broken current loop (< 3.0 mA)
Er4-20mA	4...20 mA	with indication of error statement (< 3.0 mA)
4-20mA	4...20 mA	
0-5mA	0...5 mA	
0-2 V	0...2 V	
0-5 V	0...5 V	
0-10 V	0...10 V	
+10 V	±10 V	

DEF = 4...20 mA

Type of analog output - 0...10 V > TYP.A.V. = U 10

Example: 4-20mA, 0-5mA, 0-2 V, 0-5 V, 0-10 V, MIN A.O.

MIN A.O. Assigning the display value to the beginning of the AD range

range

- range of the setting: -99999...999999

DEF = 0

Display value for the beginning of the AD range > MIN A.O. = 0

Example: 0, MAX A.O.

! Items for "Limits" and "Analog output" are accessible only if incorporated in the instrument.

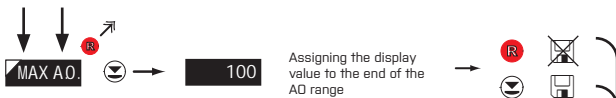

MAX A.O. Assigning the display value to the end of the AD range

- range of the setting: -99999...999999 **DEF** = 100

Display value for the end of the AD range > MAX A.O. = 120 Example

100 ◀ 100 ▶ 120 ▶ 120 ◻ COL.0

5. SETTING LIGHT

APPLICABLE ONLY TO 3-COLOUR DISPLAY

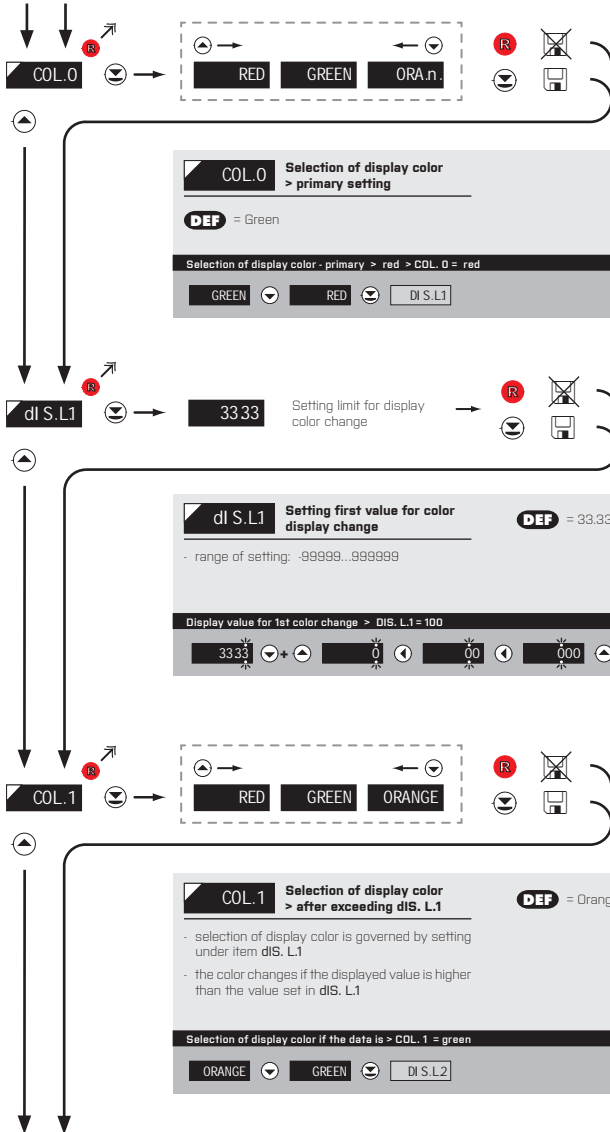

↓ ↓ ↗

dI S.L.2 → **66.67** Setting limit for display color change → **IR**

↑ ↓

dI S.L.2 **Setting second value for display color change**

- range of setting: -99999...999999 **DEF** = 66.67

Display value for 1st color change > DIS. L.2 = 400 Example

66.67 0 00 000

200 300 400 COL.2

↓ ↓ ↗

COL.2 → **RED** **GREEN** **ORANGE** **IR**

↑ ↓

COL.2 **Selection of display color > after exceeding dIS. L.2**

- selection of display color is governed by setting under item dIS. L.2 **DEF** = red

- the color changes if the displayed value is higher than the value set in dIS. L.2

Selection of display color if the data is > COL. 2 = orange Example

RED **ORANGE** **ADR.1 R**

5. SETTING LIGHT



ADR.I.R. **Setting the address of the Remote Controller**

- setting the address of the IR Remote Controller is needed only when more than one QMD 202 are within the controller's reach
- range of setting: 0...99
- possible cancellation of address is done by pressing the RC's blue button

DEF = 0

Setting the address - 21 > ADR. Ir. = 21 Example

0 1 01 11 21 MENU

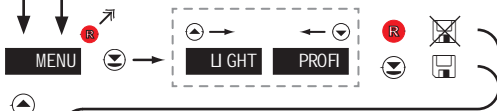

MENU **Setting the menu type LIGHT/PROFI**

- **LIGHT** > menu LIGHT, a simple menu, which contains only the most essential items necessary for instrument setting
- > linear tree structure
- **PROFI** > menu PROF, a complete menu for complete instrument setting
- > tree menu structure

DEF = LIGHT

Menu LIGHT > MENU = LIGHT Example

LI GHT RE.SET

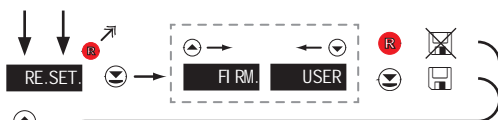

RE.SET. Restoration of manufacture instrument setting

- in the event of error setting the manufacture setting may be restored
- provided you stored your user setting in the "PROFI" menu, it may also be restored (select "USER")

- loading manufacture calibration and primary setting of items on the menu [DEF]

Restoration of manufacture setting > FIRM.

Example

RE.SET. ◀ FIRM. ▶ SAVE

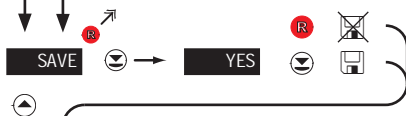

SAVE Saving the user setting

- by saving the user user setting it is possible to recall it later without the need of going through the customisation process again

Saving the user setting > SAVE

Example

SAVE ◀ YES ▶ PAS.U

5. SETTING LIGHT

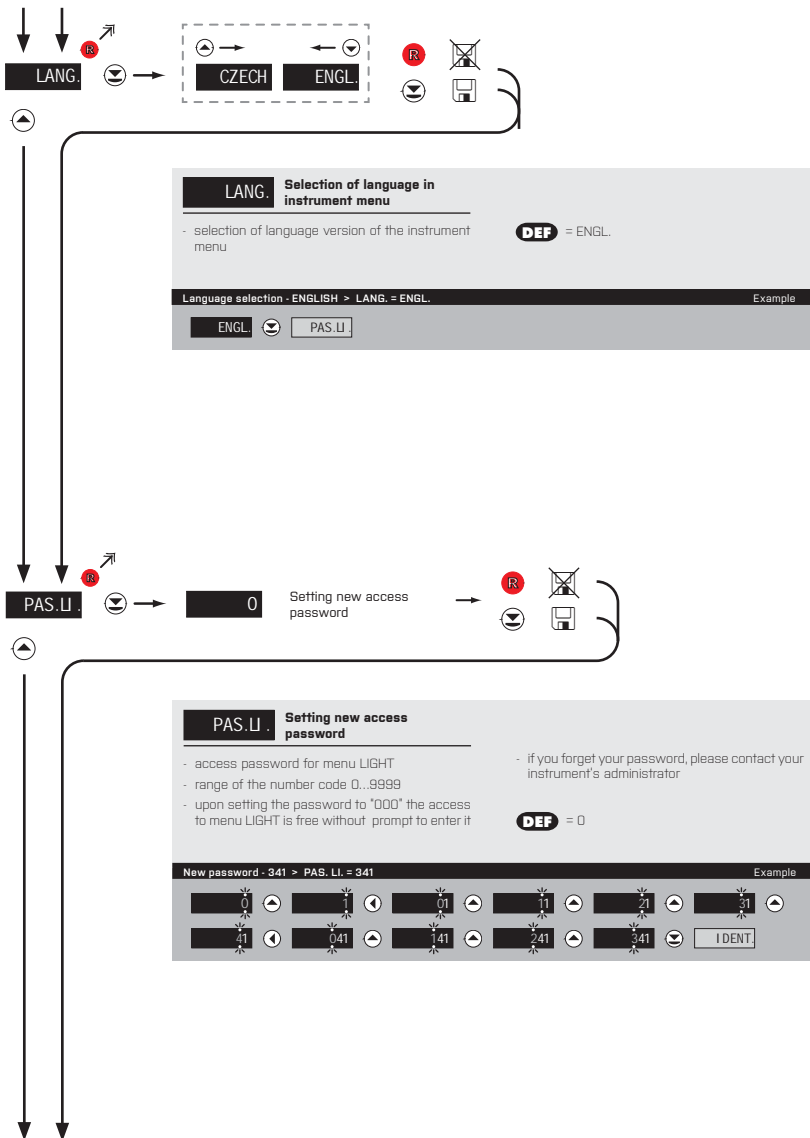

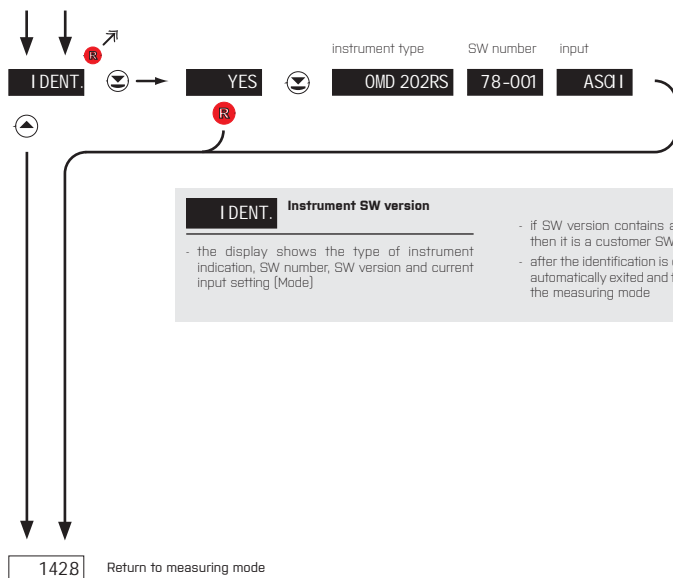



SETTING **PROFI**

For expert users

Complete instrument menu

Access is password protected

Possibility to arrange items of the **USER MENU**

Tree menu structure

6.0 SETTING "PROFI"

PROFI

Complete programming menu

- contains complete instrument menu and is protected by optional number code
- designed for expert users
- preset from manufacture is menu **LIGHT**

Switching over to "PROFI" menu

>3 s



- access to **PROFI** menu
- authorization for access to **PROFI** menu does not depend on setting under item SERVIC. > MENU
- password protected access (unless set as follows under the item SERVIC. > N. PASS. > **PROFI** =0)



- access to menu selected under item SERVIC. > MENU > LIGHT/PROFI
- password protected access (unless set as follows under the item SERVIC. > N. PASS. > **LIGHT** =0)
- for access to **LIGHT** menu passwords for **LIGHT** and **PROFI** menu may be used



6. SETTING PROFI

Programming sch

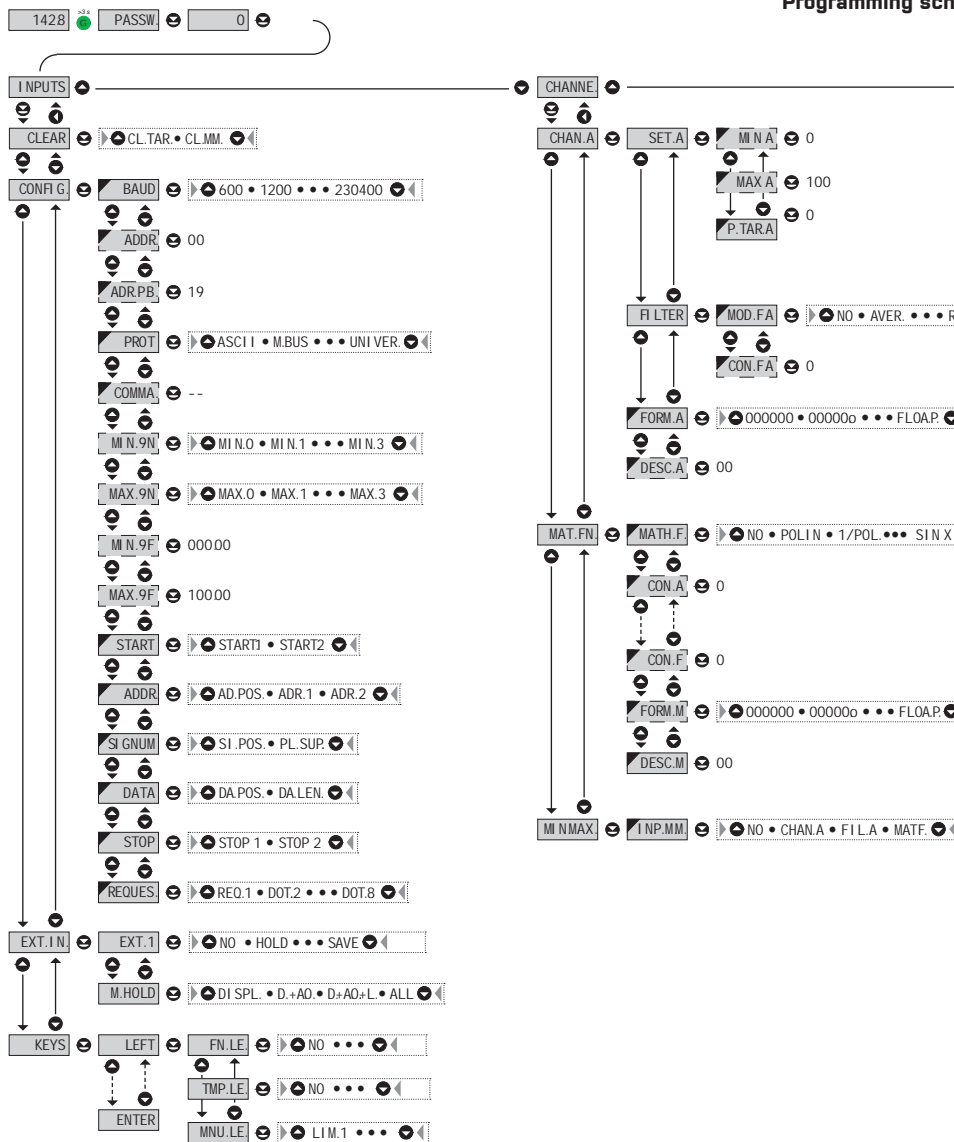

HOME PROFI MENU

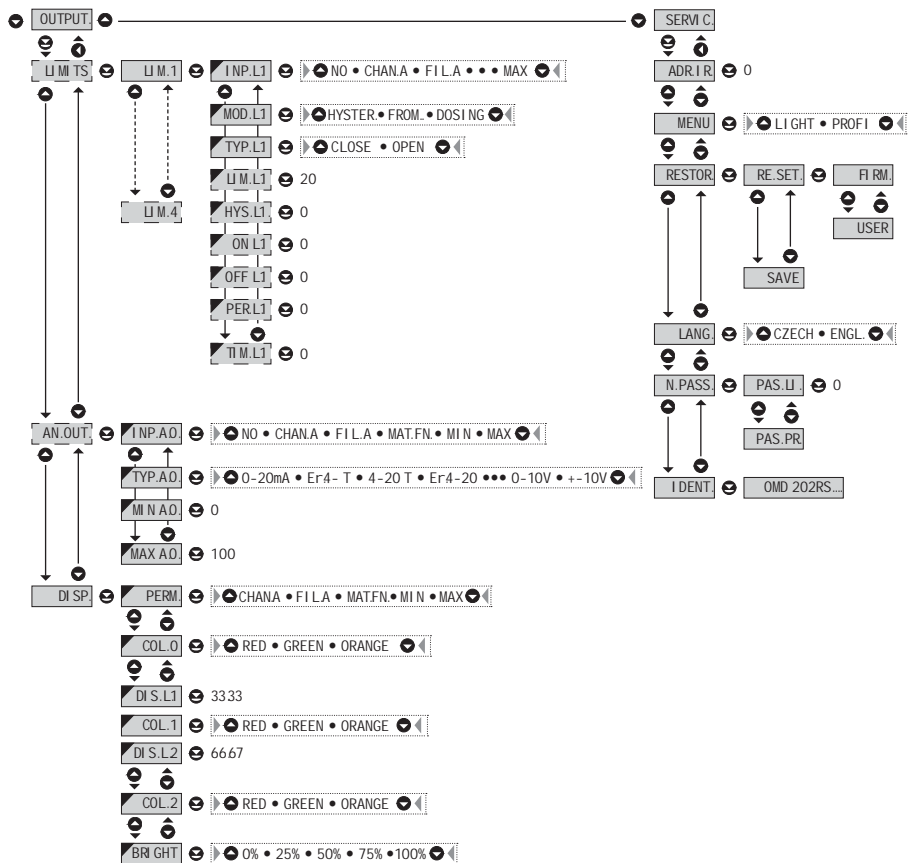

Upon delay exceeding 60 s the programming mode is automatically discontinued and the instrument itself restores the measuring mode

6. SETTING PROFI

6.1 SETTING "PROFI" - INPUT

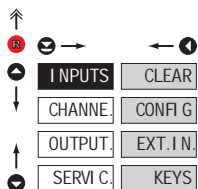

The primary instrument parameters are set in this menu

CLEAR	Resetting internal values
CONFI G.	Selection of measuring range and parameters
EXT. I.N.	Setting external inputs functions
KEYS	Assigning further functions to keys on the instrument

6.1.1 RESETTING INTERNAL VALUES

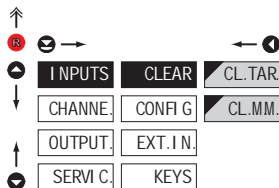

CLEAR Resetting internal values

CL.TAR	Tare resetting
CL.MM.	Resetting min/max value

- resetting memory for the storage of minimum and maximum value achieved during measurement

6.1.2a SELECTION OF DATA BAUD RATE

I NPUTS	CLEAR	BAUD	600
CHANNE.	CONF G.	ADDR	1200
OUTPUT.	EXT.I N.	ADR.PB.	2400
SERVI C.	KEYS	PROT.	4800
		COMMA	9600 DEF
		MI N. 9N	19200
		MAX. 9N	38400
		MI N. 9F	57600
		MAX. 9F	115200
		Start	230400
		ADR-Un.	
		SI GNUM	
		DATA	
		STOP	
		REQUES	
		MOD.TO	
		TI MEOU	

BAUD	Selection of data baud rate
600	Rate - 600 Baud
1200	Rate - 1200 Baud
2400	Rate - 2 400 Baud
4800	Rate - 4 800 Baud
9600	Rate - 9 600 Baud
19200	Rate - 19 200 Baud
38400	Rate - 38 400 Baud
57600	Rate - 57 600 Baud
115200	Rate - 115 200 Baud
230400	Rate - 230 400 Baud

6.1.2b SETTING INSTRUMENT ADDRESS

I NPUTS	CLEAR	BAUD	00 DEF
CHANNE.	CONF G.	ADDR	
OUTPUT.	EXT.I N.	ADR.PB.	
SERVI C.	KEYS	PROT.	
		REQUES	
		MOD.TO	
		TI MEOU	

ADDR	Setting instrument address
	- setting in range: 0...31
	- DEF = 00
ADR.PB.	Nastavení adresy přístroje - PROFIBUS
	- setting in range: 0...125
	- DEF = 19
!	
When selecting the "UNIVER." protocol, the address is set in "Adr-Un."	

6. SETTING PROFI

6.1.2c

SELECTION OF DATA PROTOCOL

↑

⊖ →

← ⊖

↑

↓

INPUTS	CLEAR	BAUD	ASQI DEF
CHANNE.	CONFI G.	ADDR.	MBUS
OUTPUT.	EXT. I N.	ADR.PB.	MASTER
SERVI C.	KEYS	PROT.	SLAVE
	COMMA	UNI VER	
	MIN. 9N		
	MAX. 9N		
	MIN. 9F		
	MAX. 9F		
	START		
	ADR-Un		
	SIGNUM		
	DATA		
	STOP		
	REQUES		
	MOD. T.O		
	TIMEOU		

↑

⊖

PROT.	Selection of data protocol
ASQI	Data protocol ASCII
M.BUS	Data protocol DIN MessBus
MASTER	Instrument solicits data from subordinate system <ul style="list-style-type: none"> - instrument controls data transmission from subordinate system - "COMMAN" may be used for selection of received data (for commands see data protocol) - instrument asks 10 questions/s, if no response arrives within 2 s the display shows ""
SLAVE	Passive Display - Slave <ul style="list-style-type: none"> - passive display - slave is used where there is communication of other instruments or a computer in the "MASTER" mode. If "COMMAND" is correctly received, the instruments will display the data.
UNI VER	Universal protocol <ul style="list-style-type: none"> - in dynamic v dynamických items (Start, Adr-Un, Num Sign, Data, Stop, Request) custom protocol can be set up



If is „COMMAND“ „uu“ (two spaces) is broadcast query on data #AA<CR>.
 Else #AA<<COMMAND>><CR> will wait on confirmation „JAA“ and after it will send out request about data #AA<CR>

6.1.2d SELECTION OF INTEGER INPUT RANGE - MINIMUM

ASCII, MESSBUS

I INPUTS	CLEAR	BAUD	MI N.0	0
CHANNE.	CONFI G.	ADDR	MI N.1	
OUTPUT.	EXT. I N.	PROT.	MI N.2	
SERVI C.	KEYS	COMMA.	MI N.3	
		MI N.9N		
		MAX.9N		
		MI N.9F		
		MAX.9F		
		MOD.TO.		
		TI MEOU.		

MI N.9N Selection of integer input range - min

- setting minimum value of input data, it is entered by individual bytes in range 0...255
- the input data format is sign integer 32 bits
- range: -2147483648...2147483647 [0x80000000...0x7FFFFFFF]

- **DEF** = 0

MI N.0	Most significant byte - min. 0
--------	-----------------------------------

MI N.1	Most significant byte - min. 1
--------	-----------------------------------

MI N.2	Most significant byte - min. 2
--------	-----------------------------------

MI N.3	Most significant byte - min. 3
--------	-----------------------------------

6.1.2e SELECTION OF INTEGER INPUT RANGE - MAXIMUM

ASCII, MESSBUS

I INPUTS	CLEAR	BAUD	MAX.0	0
CHANNE.	CONFI G.	ADDR	MAX.1	
OUTPUT.	EXT. I N.	PROT.	MAX.2	
SERVI C.	KEYS	COMMA.	MAX.3	
		MI N.9N		
		MAX.9N		
		MI N.9F		
		MAX.9F		
		MOD.TO.		
		TI MEOU.		

MAX.9N Selection of integer input range - max

- setting minimum value of input data, it is entered by individual bytes in range 0...255
- the input data format is sign integer 32 bits
- range: -2147483648...2147483647 [0x80000000...0x7FFFFFFF]

MAX.0	Most significant byte - max. 0
-------	-----------------------------------

- **DEF** = 0

MAX.1	Most significant byte - max. 1
-------	-----------------------------------

- **DEF** = 0

MAX.2	Most significant byte - max. 2
-------	-----------------------------------

- **DEF** = 0

MAX.3	Most significant byte - max. 3
-------	-----------------------------------

- **DEF** = 100

6. SETTING PROFI

6.1.2f SELECTION OF FLOAT INPUT RANGE - MINIMUM

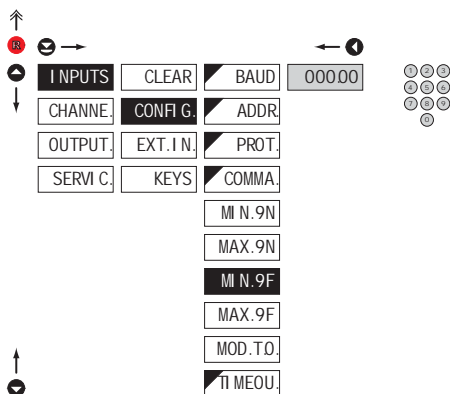

MI N. 9F Selection of float input range - minimum

- setting minimum value of input data
- input data format is float according to standard IEEE 754, 32 bits
- range: $0.3 \times 10^{-38} < |x| < 1.7 \times 10^{38}$

- DEF = 0

6.1.2g SELECTION OF FLOAT INPUT RANGE - MAXIMUM

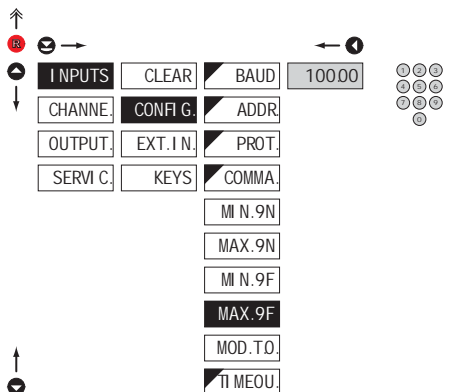

MAX. 9F Selection of float input range - maximum

- setting minimum value of input data
- input data format is float according to standard IEEE 754, 32 bits
- range: $0.3 \times 10^{-38} < |x| < 1.7 \times 10^{38}$

- DEF = 100

6.1.2h SELECTING DISPLAY MODE IN CASE OF COMMUNICATION FAILURE

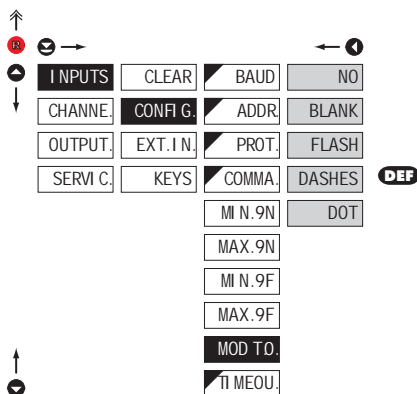
**MOD. T.O.** Selecting display mode in case of communication failure

NO	No reaction
BLANK	Display goes off
FLASH	Last displayed value starts flashing
DASHES	Dash symbols displayed
DOT	Decimal point is displayed

! Item will not appear in "MASTER" protocol

6.1.2i SETTING THE TIME CONSTANT FOR TIMEOUT

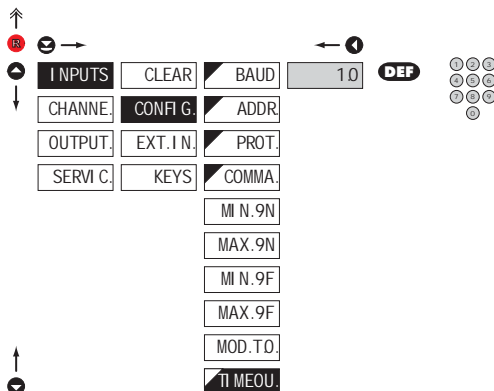
**TI MEOU.** Setting the time constant for timeout

- setting the time delay after which the indication of interrupted communication will appear on the display in the mode of "Mod. t.O."
- range: 0...99,9 s
- **DEF** = 1.0 s

! Item will not appear in "MASTER" protocol and when "MOD t.O." is disabled

6. SETTING PROFI



6.1.2j SETTING INITIAL TWO-SYMBOL SEQUENCE

PROTOCOL "UNIVERSAL"

The screenshot shows a menu with the following options:

- ↑ (Up arrow)
- Ⓡ (Red circle with 'R')
- ☺ (Smiley face)
- (Right arrow)
- ← (Left arrow)
- Ⓚ (Down arrow)
- INPUTS
- CLEAR
- BAUD
- START1
- 2
- CHANN.
- CONFI G.
- PROT.
- START2
- OUTPUT
- EXT. I N.
- START
- SERV. C.
- KEYS
- ADDR
- SI GNUM
- DATA
- STOP
- REQUES.
- MOD. T.O.
- TI MEOU.

Navigation icons: ↑, Ⓡ, ☺, →, ←, Ⓚ.

START Setting initial two-symbol sequence

START1

Setting the first introductory symbol

- set directly in ASCII code
- range: 1..127
- **DEF** = 2

START2

Setting the second introductory symbol

- set directly in ASCII code
- range: 0..127
- if set to "0", it will not be used
- **DEF** = 0

6.1.2k SETTING THE INSTRUMENT ADDRESS

PROTOCOL "UNIVERSAL"

The screenshot shows a menu with the following options:

- ↑ (Up arrow)
- Ⓡ (Red circle with 'R')
- ☺ (Smiley face)
- (Right arrow)
- ← (Left arrow)
- Ⓚ (Down arrow)
- INPUTS
- CLEAR
- BAUD
- AD.POS.
- 0
- CHANN.
- CONFI G.
- PROT.
- ADR.1
- ADR.2
- OUTPUT
- EXT. I N.
- START
- ADDR
- SERV. C.
- KEYS
- ADDR
- SI GNUM
- DATA
- STOP
- REQUES.
- MOD. T.O.
- TI MEOU.

Navigation icons: ↑, Ⓡ, ☺, →, ←, Ⓚ.

ADDR Setting the instrument address

- either address in universal protocol or one (or two) symbols of fixed value

AD.POS.

Setting the address position

- Position of the address and other symbols which have to have a set value. If set to "0", the block will not be taken into account. The block can be anywhere in the message.
- range: 0..245
- **DEF** = 0

ADR.1

First address symbol

- set directly in ASCII code
- range: 0..127
- **DEF** = 4B

ADR.2

Second address symbol

- set directly in ASCII code
- range: 0..127
- if set to "0", it will not be used
- **DEF** = 4B

6.1.2I SETTING NUMBER SIGN

PROTOCOL "UNIVERSAL"

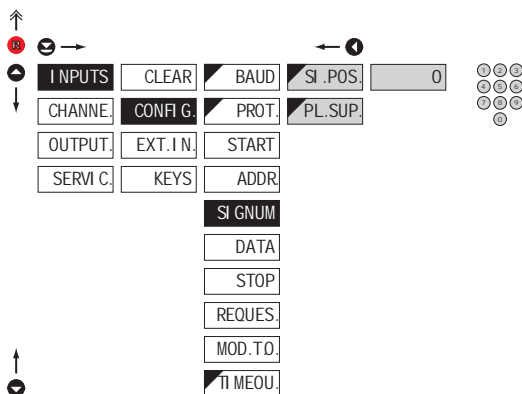
**SI GNUM** Setting number sign**SI .POS.** Setting number sign position

- Number sign position. If set to "0", it has to be part of the data. This symbol can appear anywhere within the message.

- range: 0...245

- **DEF** = 0

PL.SUP. „Plus“ number sign suppression

- option "YES" > number sign "plus" will be replaced by space

- option "NO" > number sign "plus" will be displayed

- **DEF** = YES

6.1.2m SETTING DATA FORMAT

PROTOCOL "UNIVERSAL"

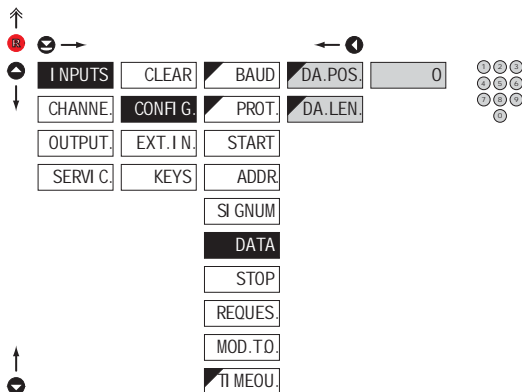
**DATA** Setting data format**DA.POS.** Setting data position

- Data position. This block can be anywhere within the message. If ending sequence is received sooner than the set number of symbols, it is considered a successful reception.

- range: 1...245

- **DEF** = 1

DA.LEN. Setting number of signs

- 7 symbols can be displayed only if there is no „minus“ sign and one of the symbols is decimal point

- range: 1..7

- **DEF** = 6

6. SETTING PROFI

6.1.2n

SETTING OF CLOSING TWO-SYMBOL SEQUENCE

PROTOCOL "UNIVERSAL"

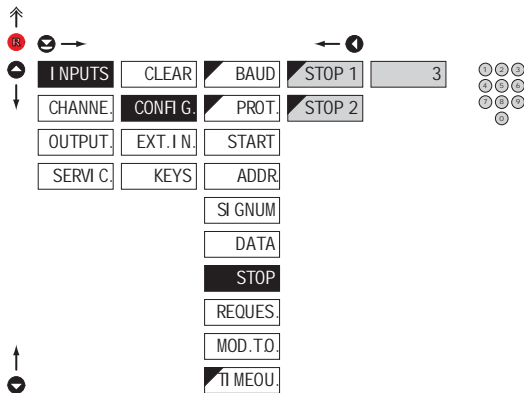

STOP

Setting of closing two-symbol sequence

- Closing sequence. None, one or two symbols. If both symbols are "0", data will be displayed after their reception.

STOP 1

Setting the first closing symbol

- set directly in ASCII code
- range: 0...127
- If set to „0“, the closing block will not be taken into account

- **DEF** = 3

STOP 2

Setting the second closing symbol

- set directly in ASCII code
- range: 0...127
- If set to „0“, the block will not be taken into account

- **DEF** = 0

6.1.2o

SETTING OF THE REQUEST TO RECEIVE DATA

PROTOCOL "UNIVERSAL"

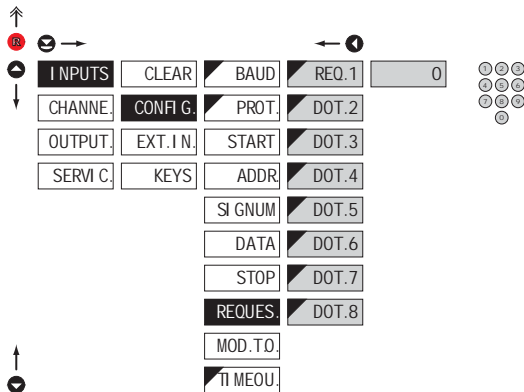

REQUES.

Setting of the request to receive data

REQ. 1

First symbol of the request

- set directly in ASCII code
- range: 0...127
- If set to "0", request is not sent

- **DEF** = 0

*

Same procedure for **Dot. 2.** **Dot. 8**

!

How to set items "Mod. t.O." and "TIMEQU." see page 51

6.1.3a EXTERNAL INPUT FUNCTION SELECTION

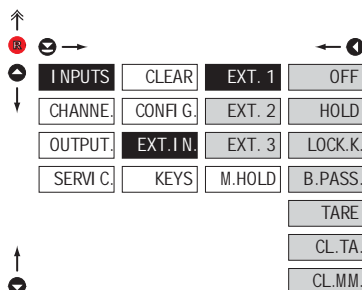
**EXT. I.N.** External input function selection

OFF	Input is off
HOLD	Activation of HOLD
LOCK.K.	Locking keys on the instrument
B.PASS.	Activation of locking access into programming menu
LIGHT/PROFI	
TARE	Tare activation
CL.TAR.	Tare resetting
CL.MM.	Resetting min/max value

- **DEF** EXT. 1 > HOLD
- **DEF** EXT. 2 > LOCK. K.
- **DEF** EXT. 3 > TARE

*

Setting procedure is identical for EXT. 2 and EXT. 3

6.1.3b SELECTION OF FUNCTION "HOLD"

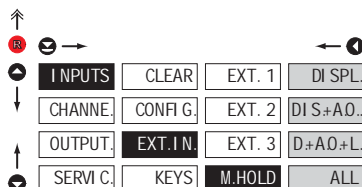
**M.MOLD** Selection of function "HOLD"

DI SPL.	"HOLD" locks only the value displayed
DI S+AO.	"HOLD" locks the value displayed and on AO
D+AO+L.	"HOLD" locks the value displayed, on AO and limit evaluation
ALL	"HOLD" locks the entire instrument

*

Setting procedure is identical for EXT. 2 and EXT. 3

6. SETTING PROFI

6.1.4a OPTIONAL ACCESSORY FUNCTIONS OF THE KEYS

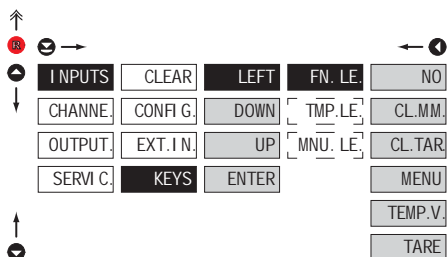

!	
Preset values of the control keys	DEF.
LEFT	Show Tare
UP	Show max. value
DOWN	Show min. value
ENTER	w/o function

FN. LE. Assigning further functions to instrument keys

- „FN. LE.“ > executive functions

NO Key has no further function

CL. MM. Resetting min/max value

CL. TAR. Tare resetting

MENU Direct access into menu on selected item

- after confirmation of this selection the "MNU. LE.", item is displayed on superior menu level, where required selection is performed

TEMP. V. Temporary projection of selected values

- after confirmation of this selection the item "TMP. LE.", is displayed on superior menu level, where required selection is performed

TARE Tare function activation

!

Setting is identical for LEFT, DOWN, UP and ENTER

6.1.4b

OPTIONAL ACCESSORY FUNCTIONS OF THE KEYS - TEMPORARY PROJECTION

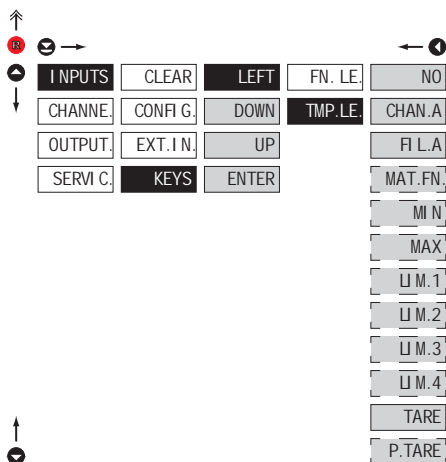
**TMP.LE.** Temporary projection of selected item

- „TMP.LE.“ > temporary projection of selected values
- "Temporary" projection of selected value is displayed for the time of keystroke
- "Temporary" projection may be switched to permanent by pressing **C** + "Selected key", this holds until the stroke of any key

NO	Temporary projection is off
CHAN.A.	Temporary projection of "Channel A" value
FI.L.A.	Temporary projection of "Channel A" value after processing digital filters
MAT.FN.	Temporary projection of "Mathematic functions" value
MIN	Temporary projection of "Min. value"
MAX	Temporary projection of "Max. value"
LIM.1	Temporary projection of "Limit 1" value
LIM.2	Temporary projection of "Limit 2" value
LIM.3	Temporary projection of "Limit 3" value
LIM.4	Temporary projection of "Limit 4" value
TARE	Temporary projection of "TARE" value
P.TARE	Temporary projection of "P. TARE" value

Setting is identical for LEFT, DOWN, UP and ENTER

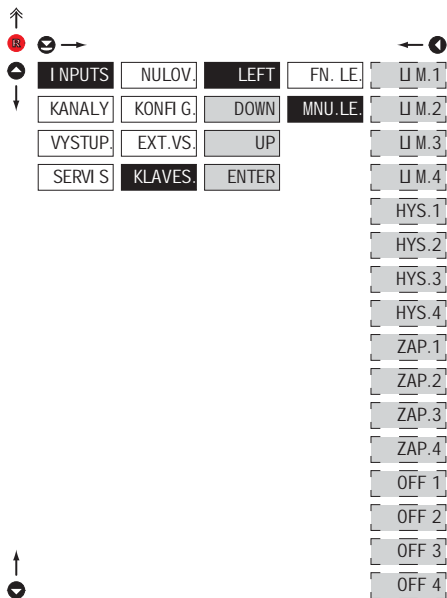
**MNU.LE.** Assigning access to selected menu item

- „MNU.LE.“ > direct access into menu on selected item

U M.1 Direct access to item "LIM 1"

U M.2 Direct access to item "LIM 2"

U M.3 Direct access to item "LIM 3"

U M.4 Direct access to item "LIM 4"

HYS.1 Direct access to item "HYS. L1"

HYS.2 Direct access to item "HYS. L2"

HYS.3 Direct access to item "HYS. L3"

HYS.4 Direct access to item "HYS. L4"

ON 1 Direct access to item "ON L1"

ON 2 Direct access to item "ON L2"

ON 3 Direct access to item "ON L3"

ON 4 Direct access to item "ON L4"

OFF 1 Direct access to item "OFF L1"

OFF 2 Direct access to item "OFF L2"

OFF 3 Direct access to item "OFF L3"

OFF 4 Direct access to item "OFF L4"



Setting is identical for LEFT, DOWN, UP and ENTER



6. SETTING PROFI

6.2 SETTING "PROFI" - CHANNEL

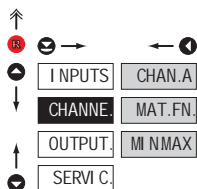

The primary instrument parameters are set in this menu

CHAN. A	Setting parameters of measuring "Channel"
MAT. FN.	Setting parameters of mathematic functions
MI NMAX	Selection of access and evaluation of Min/max value

6.2.1a DISPLAY PROJECTION

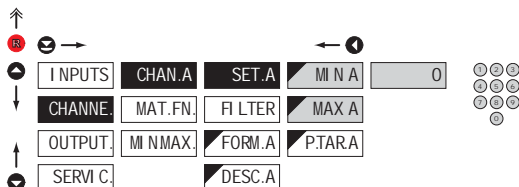

SET. A Setting display projection

MI N A	Setting display projection for minimum value of input signal
- range of the setting: .99999...999999	
- DEF = 0	
MAX A	Setting display projection for maximum value of input signal
- range of the setting: .99999...999999	
- DEF = 100	

!
This setting is only for ASCII protocol using commands 9N and 9F

6.2.1b SETTING FIXED TARE

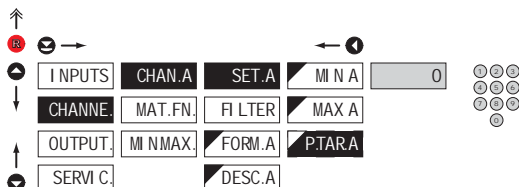

P.TARA Setting "Fixed tare" value

- setting is designed for the event when it is necessary to firmly shift the beginning of the range by known size	
- when setting [P. TARA ≠ 0] display shows "T" symbol	
- range of the setting: .99999...999999	
- DEF = 0	

!
This setting is only for ASCII protocol using commands 9N and 9F

6.2.1c DIGITAL FILTERS

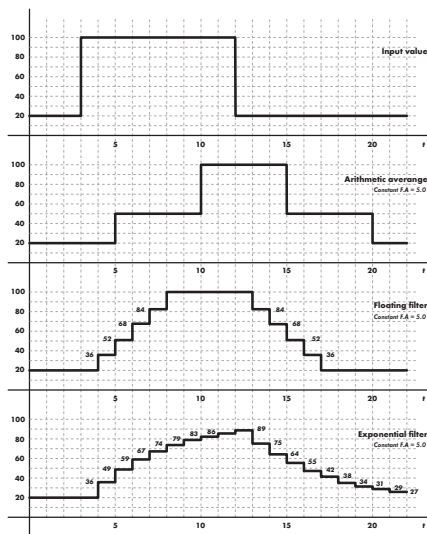
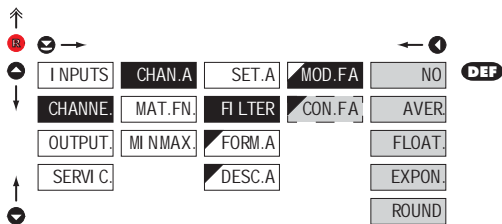
**MOD.FA** Selection of digital filters

- at times it is useful for better user projection of data on display to modify it mathematically and properly, wherefore the following filters may be used:

NO Filters are off

AVER Measured data average

- arithmetic average from given number [CON.FA] of measured values
- range: 2...100

FLOAT. Selection of floating filter

- floating arithmetic average from given number [CON.F. A'] of measured data and updates with each measured value
- range: 2...30

EXPON. Selection of exponential filter

- integration filter of first prvniho grade with time constant [CON.F. A'] measurement
- range: 2...100

ROUND Measured value rounding

- is entered by any number, which determines the projection step [e.g.: CON.F. A' = 2.5 > display 0, 2.5, 5...]

CON.FA Setting constants

- this menu item is always displayed after selection of particular type of filter

DEF = 2

6. SETTING PROFI

6.2.1d PROJECTION FORMAT - POSITIONING OF DECIMAL POINT

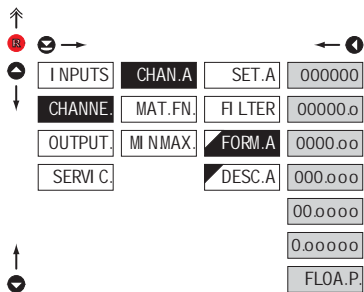

FORM.A Selection of decimal point

- the instrument allows for classic projection of a number with positioning of the DP as well as projection with floating DP, allowing to display a number in its most exact form „FLOA.P.“

000000 Setting DP - XXXXXX

DEF

00000.0 Setting DP - XXXXX.x

0000.00 Setting DP - XXXX.xx

000.000 Setting DP - XXX.xxx

00.0000 Setting DP - XX.xxxx

0.00000 Setting DP - X.xxxxx

FLOA.P. Floating DP

6.2.1e PROJECTION OF DESCRIPTION - THE MEASURING UNITS

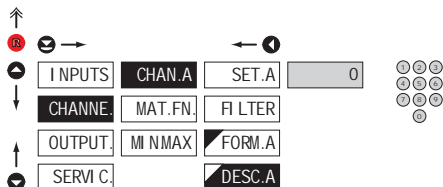

DESC.A Setting projection of descrit. for "Channel A"

- projection of measured data may be extended [at the expense of the number of displayed places] by two characters for description
- description is set by shifted ASCII code, when two first places show the set description and two last characters their code in period 0...95
- description is cancelled by code 00

- DEF = no description



Table of signs on page 83

6.2.2a

MATHEMATIC FUNCTIONS

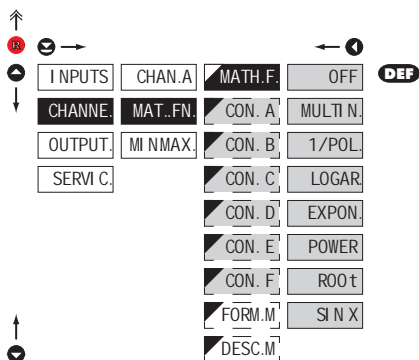
**MATH. F.****Selection of mathematic functions**

OFF

Mathematic functions are off

MULTI N.

Polynome

$$Ax^5 + Bx^4 + Cx^3 + Dx^2 + Ex + F$$

1/POL.

1/x

$$\frac{A}{x^5} + \frac{B}{x^4} + \frac{C}{x^3} + \frac{D}{x^2} + \frac{E}{x} + F$$

LOGAR

Logarithm

$$A \times \ln\left(\frac{Bx + C}{Dx + E}\right) + F$$

EXPON.

Exponenciál

$$A \times e^{\left(\frac{Bx+C}{Dx+E}\right)} + F$$

POWER

Power

$$A \times (Bx + C)^{(Dx+E)} + F$$

ROO t

Root

$$A \times \sqrt{\frac{Bx + C}{Dx + E}} + F$$

SI N X

Sin x

$$A \sin^5 x + B \sin^4 x + C \sin^3 x + D \sin^2 x + E \sin x + F$$

CON.**Setting constants for calculation of mat. functions**

- this menu is displayed only after selection of given mathematic function

6. SETTING PROFI

6.2.2b MATHEMATIC FUNCTIONS - DECIMAL POINT

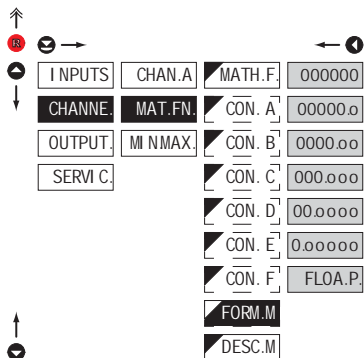

FORM.M Selection of decimal point

- the instrument allows for classic projection of a number with positioning of the DP as well as projection with floating DP, allowing to display a number in its most exact form „FLOA.P.“

000000	Setting DP - XXXXXX
00000.0	Setting DP - XXXXX.x
0000.00	Setting DP - XXXX.xx
000.000	Setting DP - XXX.xxx
00.0000	Setting DP - XX.xxxx
0.00000	Setting DP - X.xxxxx
FLOA.P.	Floating DP

DEF

6.2.2c MATHEMATIC FUNCTIONS - MEASURING UNITS

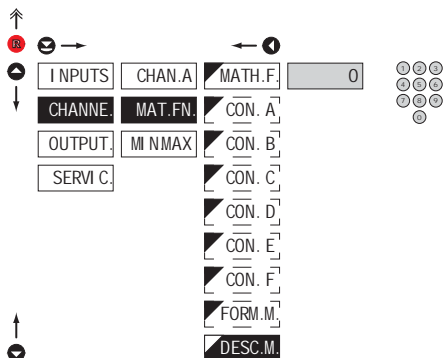

DESC.M Setting projection of description for "MATH. F."

- projection of measured data may be extended (at the expense of the number of displayed places) by two characters for description
- description is set by shifted ASCII code, when two first places show the set description and two last characters their code in period 0...95
- description is cancelled by code 00
- **DEF** = no description

! Table of signs on page 83

6.2.3 SELECTION OF EVALUATION OF MIN/MAX VALUE

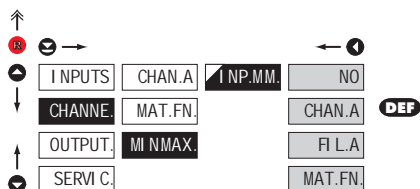

I NP. MM. Selection of evaluation of min/max value

- selection of value from which the min/max value will be calculated

- | | |
|----------|---|
| NO | Evaluation of min/max value is off |
| CHAN. A | From "Channel A" |
| FIL. A | From "Channel A" after digital filters processing |
| MAT. FN. | From "Mathematic functions" |

6. SETTING PROFI

6.3 SETTING „PROFI“ - OUTPUTS

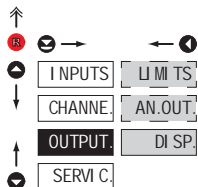

In this menu it is possible to set parameters of the instrument output signals

L I M I T S	Setting type and parameters of limits
A N . O U T	Setting type and parameters of analog output
D I S P.	Setting display projection and brightness

6.3.1a SELECTION OF INPUT FOR LIMITS EVALUATION

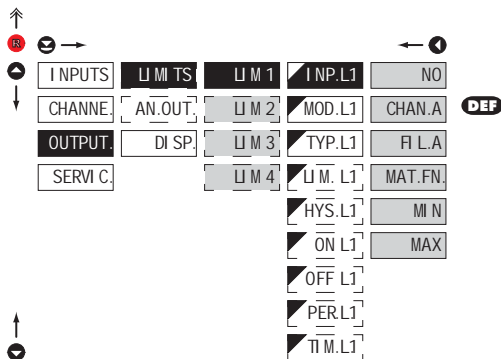

I N P . L 1	Selection evaluation of limits
-	selection of value from which the limit will be evaluated
N O	Limit evaluation is off
C H A N . A	Limit evaluation from "Channel A"
F I L . A	Limit evaluation from "Channel A" after digital filters processing
M A T . F N	Limit evaluation from "Mathematic functions"
M I N	Limit evaluation from "Min.value"
M A X	Limit evaluation from "Max. value"

! Setting is identical for LIM 1, LIM 2, LIM 3 and LIM 4

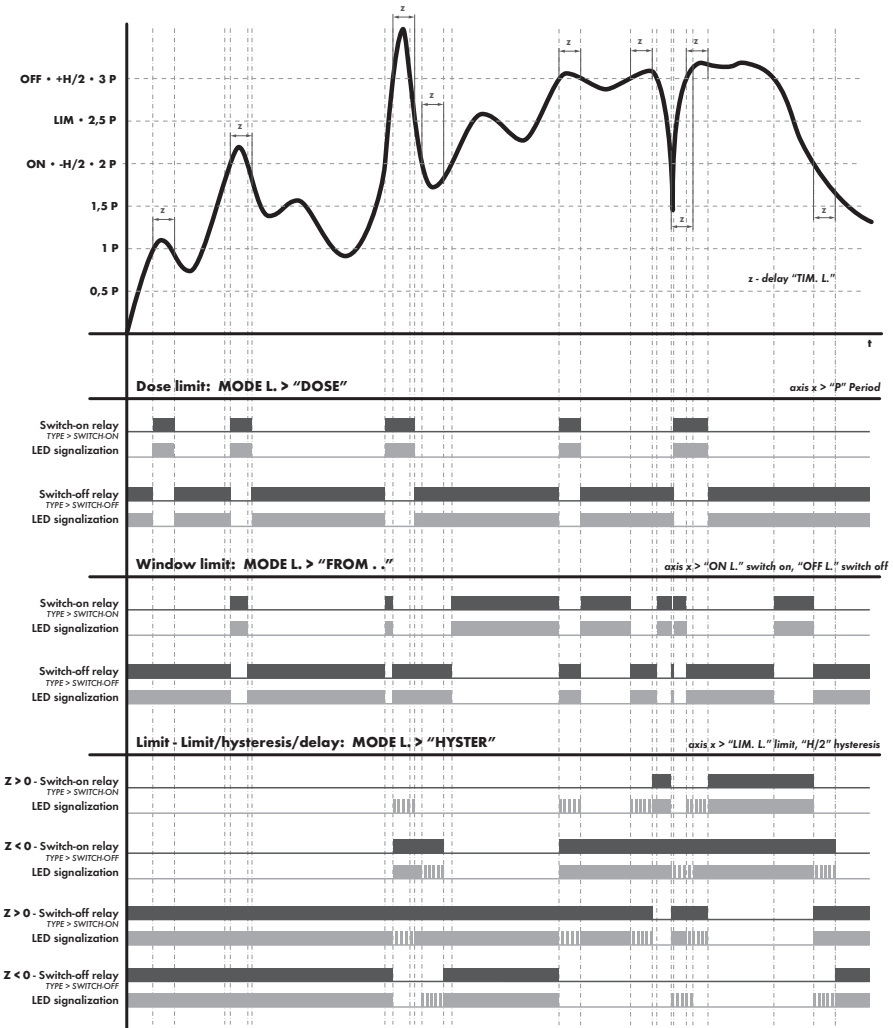

6. SETTING PROFI

6.3.1b SELECTION THE TYPE OF LIMIT

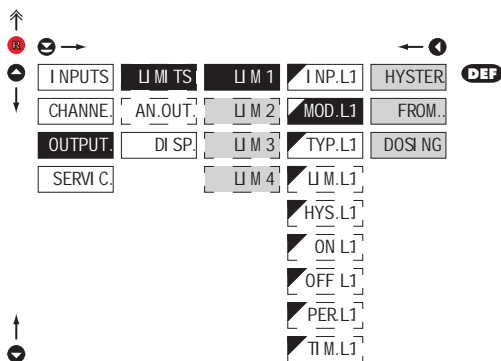

MOD.L1 Selection the type of limit

HYSTER. Limit is in mode "Limit, hysteresis, delay"

- for this mode the parameters of "LIM.L1" are set, at which the limit will shall react, "HYS.L1" the hysteresis range around the limit (LIM ±1/2 HYS) and time "TIM.L1" determining the delay of relay switch-on

FROM.. Frame limit

- for this mode the parameters are set for interval "ON.L1" the relay switch-on and "OFF.L1" the relay switch-off

DOSI NG Dose limit (periodic)

- for this mode the parameters are set for "PER.L1" determining the limit value as well as its multiples at which the output is active and "TIM.L1" indicating the time during which is the output active



Setting is identical for LIM 1, LIM 2, LIM 3 and LIM 4

6.3.1c SELECTION OF TYPE OF OUTPUT

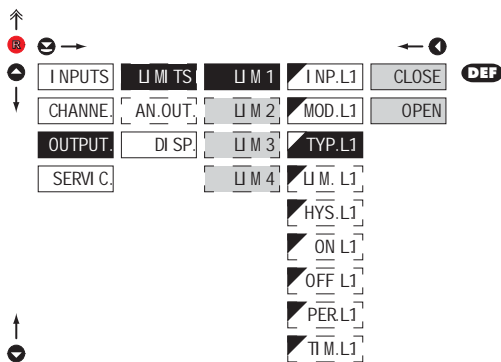

TYP.L1 Selection of type of output

CLOSE Output switches on when condition is met

OPEN Output switches off when condition is met



Setting is identical for LIM 1, LIM 2, LIM 3 and LIM 4

6.3.1d

SETTING VALUES FOR LIMITS EVALUATION

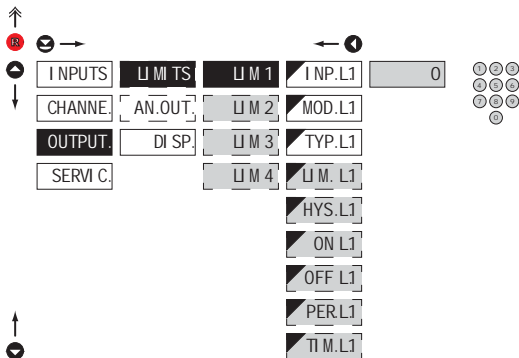

LIM.L1

 Setting limit for switch-on

- for type "HYSTER."

HYS.L1

 Setting hysteresis

- for type "HYSTER."
- indicates the range around the limit (in both directions, $LIM. \pm \sqrt{2} HYS.$)

ON L1

 Setting the outset of the interval of limit switch-on

- for type "FROM."

OFF L1

 Setting the end of the interval of limit switch-on

- for type "FROM."

PER.L1

 Setting the period of limit switch-on

- for type "DOSING"

TIM.L1

 Setting the time switch-on of the limit

- for type "HYSTER." and "DOSING"
- setting within the range: $\pm 99,9$ s
- positive time > relay switches on after crossing the limit (LIM.L1) and the set time (TIM.L1)
- negative time > relay switches off after crossing the limit (LIM.L1) and the set negative time (TIM.L1)



Setting is identical for LIM 1, LIM 2, LIM 3 and LIM 4

6. SETTING PROFIBUS

6.3.2a SELECTION OF INPUT FOR ANALOG OUTPUT

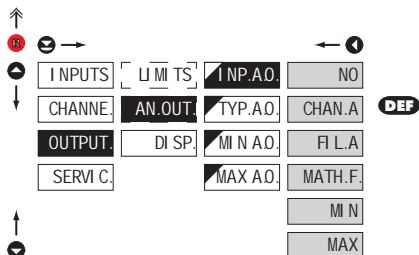

I NP.A.O. Selection evaluation analog output

- selection of value from which the analog output will be evaluated

NO	AD evaluation is off
CHAN.A	AD evaluation from "Channel A"
FI L.A	AD evaluation from "Channel A" after digital filters processing
MAT.FN.	AD evaluation from "Math. functions"
MI N	AD evaluation from "Min. value"
MAX	AD evaluation from "Max. value"

6.3.2b SELECTION OF THE TYPE OF ANALOG OUTPUT

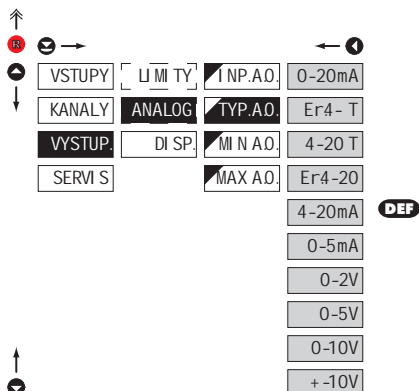

TYP.A.O. Selection of the type of analog output

0-20mA	Type: 0...20 mA
Er4 - T	Type: 4...20 mA, with broken loop detection and indication of error statement (< 3,0 mA)
4-20 T	Type: 4...20 mA, with broken loop detection (< 3,0 mA)
Er4-20	Type: 4...20 mA, with indic. of error statement [< 3,0 mA]
4-20mA	Type: 4...20 mA
0-5mA	Type: 0...5 mA
0-2V	Type: 0...2 V
0-5V	Type: 0...5 V
0-10V	Type: 0...10 V
+ -10V	Type: ± 10 V

6.3.2c SETTING THE ANALOG OUTPUT RANGE

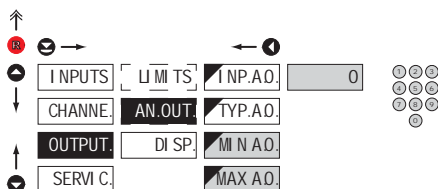
**AN.OUT.** Setting the analog output range

- analog output is isolated and its value corresponds with displayed data. It is fully programmable, i.e. it allows to assign the AD limit points to two arbitrary points of the entire measuring range

MIN.A.O. Assigning the display value to the beginning of the

AD range

- range of the setting: -99999...999999

- **DEF** = 0**MAX.A.O.** Assigning the display value to the end of the AD range

- range of the setting: -99999...999999

- **DEF** = 100

6.3.3a SELECTION OF INPUT FOR DISPLAY PROJECTION

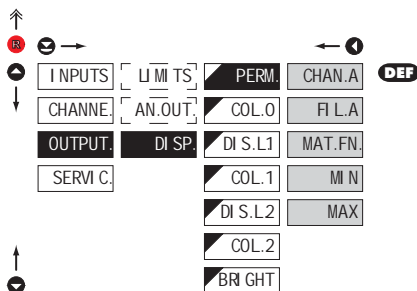
**PERM.** Selection display projection

- selection of value which will be shown on the instrument display

CHAN.A Projection of values from "Channel A"

- „raw“ data will be projected on the display in the format they have been received by the instrument

FIL.A Projection of values from "Channel A" after digital filters processing

- data which have been successfully converted to numbers will be projected

MAT.FN. Projection of values from "Math. functions"**MIN** Projection of values from "Min. value"**MAX** Projection of values from "Max. value"

6. SETTING PROFI

6.3.3b SELECTION OF DISPLAY COLOR

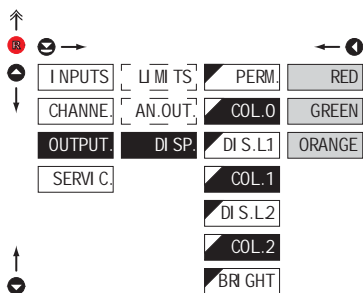

COL. - Selection of display color

- the color selection is governed by setting under items 'DIS. L1' and 'DIS. L2'

RED Red color

GREEN Green color

ORANGE Orange color

- 'COL. 0' **DEF** = Green
- 'COL. 1' **DEF** = Orange
- 'COL. 2' **DEF** = Red

! Not applicable to the version with monocolour high brightness LED display

6.3.3c SELECTION OF DISPLAY COLOR CHANGE

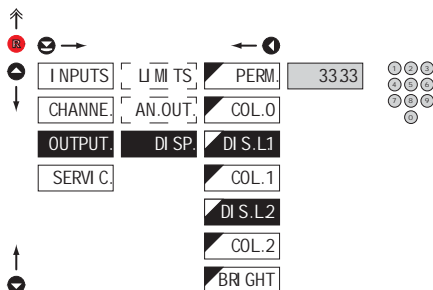

DIS. L. - Selection of display color change

- under items 'DIS. L1' and 'DIS. L2' the limit is set for the time when the display color shall change

- 'DIS. L1' **DEF** = 33.33
- 'DIS. L2' **DEF** = 66.67

! Not applicable to the version with monocolour high brightness LED display

6.3.3d

SELECTION OF DISPLAY BRIGHTNESS

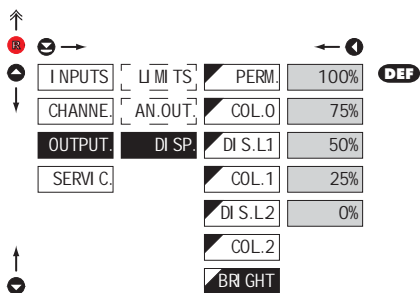
**BRI GHT** Selection of display brightness

- by selecting display brightness we may appropriately react to light conditions in place of instrument location

0% Display is off

- after keystroke display turns on for 10 s

25% Display brightness - 25%

50% Display brightness - 50%

75% Display brightness - 75%

100% Display brightness - 100%

6. SETTING PROFI

6.4 SETTING "PROFI" - SERVICE

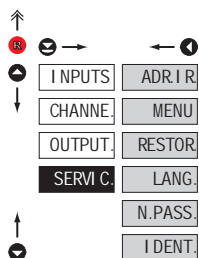

The instrument service functions are set in this menu

ADR.I.R.	Setting the address of IR control
MENU	Selection of menu type LIGHT/PROFI
RESTOR.	Restore instrument manufacture setting and calibration
LANG.	Language version of instrument menu
N.PASS.	Setting new access password
I.DENT.	Instrument identification

6.4.1 SETTING THE ADDRESS OF IR REMOTE CONTROL

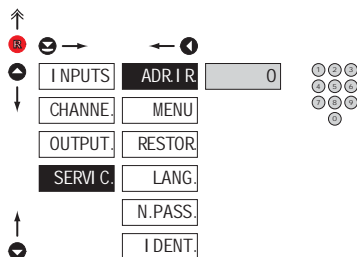

ADR.I.R. Setting the address of IR remote control

- setting the remote control address is inevitable only in case there are other large displays OMD 202 within the reach of IR remote control
- range of the setting: 0...99
- **DEF** = 0

Controlling addressed instrument

- if the OMD has an address different than „0“
- press the green button and key in the address of the controlled device
- after establishing communication a yellow signalling LED lights up on the display
- then you can control the display in the standard way in LIGHT/PROFI/USER menu
- if needed, the address can be cancelled by pressing the blue button of the remote

6.4.2 SELECTION OF TYPE OF PROGRAMMING MENU

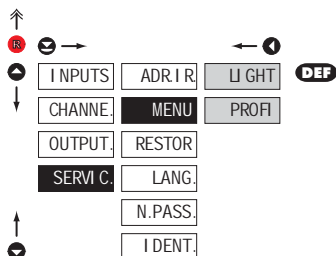
**MENU** Selection of menu type
LIGHT/PROFI

- enables setting the menu complexity according to user needs and skills

LI GHT Active LIGHT menu

- simple programming menu, contains only items necessary for configuration and instrument setting
- linear menu > items one after another

PROFI Active PROFI menu

- complete programming menu for expert users
- tree menu

!
Change of setting is valid upon next access into menu

6.4.3 RESTORATION OF MANUFACTURE SETTING

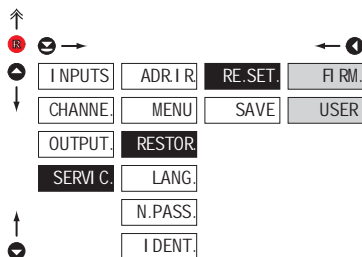
**RE.SET.** Restoration of
manufacture setting**FI RM.** Return to manufacture
setting of the instrument

- reading the primary setting of items in menu (DEF)

USER Restoration of instrument
user setting

- reading user setting of the instrument, i.e. setting stored under **SERVI C./RESTOR/SAVE**

SAVE Save instrument user
setting

- storing the user setting allows the operator to restore it in future if needed

!
After restoration the instrument switches off for couple seconds

6. SETTING PROFI

6.4.4 SELECTION OF INSTRUMENT MENU LANGUAGE VERSION

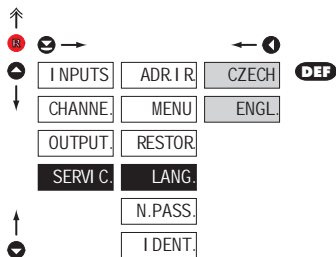

LANG. Selection of instrument menu language version

CZECH Instrument menu is in Czech

ENGL. Instrument menu is in English

6.4.5 SETTING NEW ACCESS PASSWORD

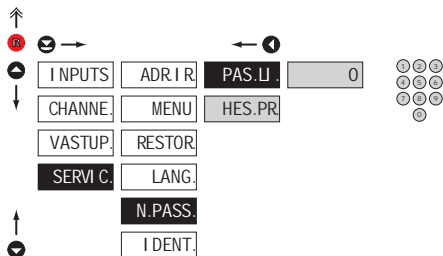

N.PASS. Setting new password for access to LIGHT and PROFi menu

- this option allows to change the numeric code, which blocks the access into LIGHT and PROFi Menu.
- numerical code range: 0...9999
- universal passwords in the event of loss:
LIGHT Menu > „8177”
PROFI Menu > „7915”

6.4.6 INSTRUMENT IDENTIFICATION

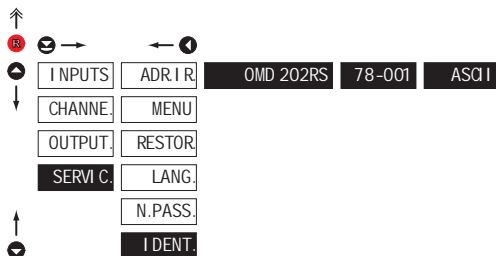

I DENT. Projection of instrument SW version

- display shows type identification of the instrument, SW number, SW version and current input setting (Mode)
- if the SW version reads a letter on first position, it is a customer SW

	Blok	Description
I DENT.	1.	Instrument
	2.	no. of SW version
	3.	type/input mode





SETTING USER

For user operation

Menu items are set by the user (Profi/Light) as per request

Access is not password protected

Optional menu structure either tree (PROFI) or linear (LIGHT)

7.0 SETTING ITEMS INTO "USER" MENU

- **USER** menu is designed for users who need to change only several items of the setting without the option to change the primary instrument setting (e.g. repeated change of limit setting)
- there are no items from manufacture permitted in **USER** menu
- on items indicated by inverse triangle  L 1
- setting may be performed in **LIGHT** or **PROFI** menu, with the **USER** menu then overtaking the given menu structure

Setting

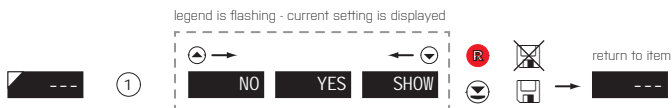

NO

item will not be displayed in USER menu

YES

item will be displayed in USER menu with the option of setting

SHOW

item will be solely displayed in USER menu

Setting items into „USER” menu

When setting up the USER menu out of active LIGHT menu it is possible to rank the menu items (max. 10) in the order we want them to appear in the menu.

Setting up the ranking order



Example of setting up menu items into "USER" menu

As an example we are going to use a direct access into menu items Limit1 and Limit2 (the given example is for Light menu but can be applied also in Profi menu).

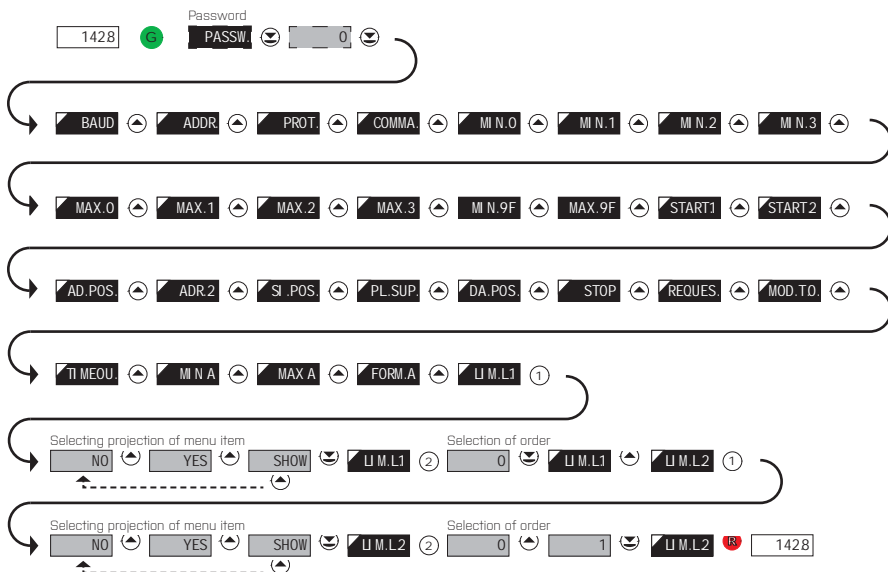

The resulting setting is as follows: After pressing button **R** „LIM.L1” is projected. By pressing **☒** you confirm this and you set the desired limit value, alternatively by pressing button **☒** you can go over to setting of „LIM.L.2” where you repeat the procedure. You can finish the setting up by pressing the **☒** button, by which you save the latest setting and by pressing the **R** you return to the operating mode.

8. DATA PROTOCOL



The instruments communicate via serial line RS232 or RS485. For communication they use the ASCII protocol. Communication runs in the following format:

ASCII: 8 bit, no parity, one stop bit

DIN MessBus: 7 bit, even parity, one stop bit

The transfer rate is adjustable in the instrument menu. The instrument address is set in the instrument menu in the range of 0 ÷ 31. The manufacture setting always presents the ASCII protocol, rate of 9600 Baud, address 00. The type of line used - RS232 / RS485 - is determined by an output board automatically identified by the instrument.

The commands are described in specifications you can find at [na www.orbit.merret.cz/rs](http://na.www.orbit.merret.cz/rs) or in the DM Link program.

DETAILED DESCRIPTION OF COMMUNICATION VIA SERIAL LINE

EVENT	TYPE	PROTOCOL	TRANSMITTED DATA
Data sollicitation (PC)	232	ASCII	# A A <CR>
		MessBus	No - data is transmitted permanently
	485	ASCII	# A A <CR>
		MessBus	<SADR> <END>
Data transmission (instrument)	232	ASCII	> 0 [0] [0] [0] [0] [0] [0] [0] [0] [0] [0] [0] [0] <CR>
		MessBus	<STX> 0 [0] [0] [0] [0] [0] [0] [0] [0] [0] [0] [0] <ETX> <BCC>
	485	ASCII	> 0 [0] [0] [0] [0] [0] [0] [0] [0] [0] [0] [0] <CR>
		MessBus	<STX> 0 [0] [0] [0] [0] [0] [0] [0] [0] [0] [0] [0] <ETX> <BCC>
Confirmation of data acceptance (PC) OK	485	MessBus	<DLE> 1
Confirmation of data acceptance (PC) Bad			<NAK>
Sending address (PC) prior command			<EADR> <END>
Confirmation of address (instrument)			<SADR> <END>
Command transmission (PC)	232	ASCII	# A A N P [0] [0] [0] [0] [0] [0] [0] [0] <CR>
		MessBus	<STX> S N P [0] [0] [0] [0] [0] [0] [0] [0] <ETX> <BCC>
	485	ASCII	# A A N P [0] [0] [0] [0] [0] [0] [0] [0] <CR>
		MessBus	<STX> S N P [0] [0] [0] [0] [0] [0] [0] [0] <ETX> <BCC>
Command confirmation (instrument)	232	ASCII	OK A A <CR>
		Bad	? A A <CR>
		Messbus	No - data is transmitted permanently
		Messbus	No - data is transmitted permanently
	485	ASCII	OK A A <CR>
		Bad	? A A <CR>
		Mess-Bus	OK <DLE> 1
		Bad	<NAK>
Instrument identification			# A A 1 Y <CR>
HW identification			# A A 1 Z <CR>
One-time transmission			# A A 7 X <CR>
Repeated transmission			# A A 8 X <CR>

LEGEND

SIGN	RANGE	DESCRIPTION
#	35 23 _H	Command beginning
A	A 0...31	Two characters of instrument address (sent in ASCII - tens and units, e.g. "01", "99" universal)
<CR>	13 00 _H	Carriage return
<SP>	32 20 _H	Space
N, P		Number and command - command code
D		Data - usually characters "0"... "9", "*", ";", ":", "[]"; [D] - dp, and [] may prolong data
R	30 _H ...3F _H	Relay and tare status
!	33 21 _H	Positive confirmation of command (ok)
?	63 3F _H	Negative confirmation of command (point)
>	62 3E _H	Beginning of transmitted data
<STX>	2 02 _H	Beginning of text
<ETX>	3 03 _H	End of text
<SADR>	adresa +60 _H	Prompt to send from address
<EADR>	adresa +40 _H	Prompt to accept command at address
<END>	5 05 _H	Terminate address
<DLE>	1 16 49 10 _H , 31 _H	Confirm correct statement
<NAK>	21 15 _H	Confirm error statement
<BCC>		Check sum -XDR

COMMANDS RS monitors

#AA9dddddd<CR>

Reception of alpha-numerical data

- ddddd is data which is to be displayed
- maximum of 6 symbols and 2 decimal points

#AA9NIHHHHHHH<CR>

Selection of integer input range

- hexa number in sign long integer format (signed long integer)
- range: :2147483648...2147483647 (0x80000000...0x00000000...0x7FFFFFFF)

#AA9FHHHHHHHH<CR>

Selection of float input range

- hexa number, corresponding binary presentation of number with floating DP according to standard IEEE-754 (single/short float)
- significance of individual bites

SEEEEEEE EMMMMMMM MMMMMMMM MMMMMMMM

where: S ... signum (1 bit)
E ... exponent, incl. the signum (8 bit)
M ... mantissa (23 bits)

- range: $0.3 \times 10^{-38} \leq |x| \leq 1.7 \times 10^{38}$

For both commands applies the rule:

If less data is sent out, they are supplemented from the right with zeros to full length. It enables contingent acceleration of communication. E.g. #009F4<CR> is identical as #009F40000000<CR>. They both send away number 2,0.

Protocol DIN MessBus

<EADR><END> >>> answer OK <DLE> 1

<STX>\$9 ddddd <ETX><BCC>

RELAYS, TARE

SIGN	RELAY 1	RELAY 2	TARE	CHANGE RELAY 3/4
P	0	0	0	0
Q	1	0	0	0
R	0	1	0	0
S	1	1	0	0
T	0	0	1	0
U	1	0	1	0
V	0	1	1	0
W	1	1	1	0
p	0	0	0	1
q	1	0	0	1
r	0	1	0	1
s	1	1	0	1
t	0	0	1	1
u	1	0	1	1
v	0	1	1	1
w	1	1	1	1

Relay status is generated by command #AABX <CR>.

The instrument immediately returns the value in the format >HH <CR>, where HH is value in HEX format and range 00H...FFH. The lowest bit stands for „Relay 1“, the highest for „Relay 8“



If channel Mathematical Functions (MF) is active, the first symbol must not be 'X'. This symbol is not supported.

9. ERROR STATEMENTS



ERROR	CAUSE	ELIMINATION
E.D.UN.	Number is too small (large negative) to be displayed	change DP setting, channel constant setting
E.D.OV.	Number is too large to be displayed	change DP setting, channel constant setting
E.T.UN.	Number is outside the table range	increase table values, change input setting (channel constant setting)
E.T.OV.	Number is outside the table range	increase table values, change input setting (channel constant setting)
E.I.UN.	Input quantity is larger than permitted input quantity range	change input signal value or input (range) setting
E.I.OV.	Input quantity is larger than permitted input quantity range	change input signal value or input (range) setting
E.HW.	A part of the instrument does not work properly	send the instrument for repair
E.EE	Data in EEPROM corrupted	perform restoration of manufacture setting, upon repeated error statement send instrument for repair
E.SET.	Data in EEPROM outside the range	perform restoration of manufacture setting, upon repeated error statement send instrument for repair
E.CLR.	Memory was empty (presetting carried out)	upon repeated error statement send instrument for repair, possible failure in calibration
E.OUT.	Analogue output current loop disconnected	check wire connection

The instrument allows to add two descriptive characters to the classic numeric formats (at the expense of the number of displayed places). The setting is performed by means of a shifted ASCII code. Upon modification the first two places display the entered characters and the last two places the code of the relevant symbol from 0 to 95. Numeric value of given character equals the sum of the numbers on both axes of the table.

Description is cancelled by entering characters with code 00

	0	1	2	3	4	5	6	7		0	1	2	3	4	5	6	7
0		l	"	8	5	'	2	'	0	!	"	#	\$	%	&	'	
8	[]	H	-	,	-		2	8	()	*	+	,	-	.	/
16	0	1	2	3	4	5	6	7	16	0	1	2	3	4	5	6	7
24	8	9	=	,	c	=	3	2	24	8	9	:	;	<	=	>	?
32	J	R	b	[d	E	F	G	32	@	A	B	C	D	E	F	G
40	H	I	J	K	L	M	N	O	40	H	I	J	K	L	M	N	O
48	P	Q	R	S	T	U	V	W	48	P	Q	R	S	T	U	V	W
56	H	Y	2	[4]	^	-	56	X	Y	Z	[\]	^	_
64	'	R	b	c	d	E	F	G	64	`	a	b	c	d	e	f	g
72	h	i	j	k	l	m	n	o	72	h	i	j	k	l	m	n	o
80	P	Q	R	S	T	U	V	W	80	p	q	r	s	t	u	v	w
88	H	Y	2	-	I	T	0		88	x	y	z	{		}	~	

Table ASCII

0	1	2	3	4	5	6	7	8	9	10	11	12	13	14	15	16	17	18	19
NUL	SOH	STX	ETX	EOT	ENQ	ACK	BEL	BS	HT	LF	VT	FF	CR	SO	SI	DLE	DC1	DC2	DC3
20	21	22	23	24	25	26	27	28	29	30	31	32	33	34	35	36	37	38	39
DC4	NAC	SYN	ETB	CAN	EM	SUB	ESC	FS	CS	RS	US	SP	!	.	#	\$	%	&	,
40	41	42	43	44	45	46	47	48	49	50	51	52	53	54	55	56	57	58	59
[]	*	+	,	-	.	/	0	1	2	3	4	5	6	7	8	9	:	;
60	61	62	63	64	65	66	67	68	69	70	71	72	73	74	75	76	77	78	79
<	=	>	?	@	A	B	C	D	E	F	G	H	I	J	K	L	M	N	O
80	81	82	83	84	85	86	87	88	89	90	91	92	93	94	95	96	97	98	99
P	Q	R	S	T	U	V	W	X	Y	Z	[\]	^	_	`	a	b	c
100	101	102	103	104	105	106	107	108	109	110	111	112	113	114	115	116	117	118	119
d	e	f	g	h	i	j	k	l	m	n	o	p	q	r	s	t	u	v	w
120	121	122	123	124	125	126	127												
x	y	z	{		}	~	DEL												

**INPUT**

Protocol:	ASCII, MessBus, Modbus RTU, PROFIBUS DP
Data format:	8 bit + no parity + 1 stop bit (ASCII) 7 bit + even parity + 1 stop bit (MessBus) Universal protocol
Rate:	600...230 400 Baud 9 600...12 000 Kbaud (PROFIBUS)
RS 232:	isolated, two-way communication
RS 485:	isolated, two-way communication, addressing (in range 1...247)

PROJECTION

Display:	999999, 4 [100/125 mm] or 6 digit [57/100/125 mm] Three-color 7 segment LED - red/green/orange High bright singles LED - red or green [1300 mcd]
Projection:	-999...9999 or -99999...999999
Decimal point:	adjustable - in menu
Brightness:	adjustable - in menu

INSTRUMENT ACCURACY

Linearisation:	by linear interpolation in 50 points - solely via OM Link
Digital filters:	Averaging, Floating average, Exponential filter, Rounding
Functions:	Tare - display resetting Hold - stop measuring [at contact] Lock - control key locking MM - min/max value Mathematic functions
OM Link:	company communication interface for setting, operation and update of instrument SW reset after 400 ms
Watch-dog:	at 25°C and 40% of r.h.
Calibration:	at 25°C and 40% of r.h.

COMPARATOR

Type:	digital, adjustable in menu
Mode:	Hysteresis, From, Dosing
Limits:	-99999...999999
Hysteresis:	0...999999
Delay:	0...99,9 s
Outputs:	4x relays with switch-on contact [Form A] [230 VAC/30 VDC, 3 A]* 4x open collectors [30 VDC/100 mA]
Relay:	1/8 HP 277 VAC, 1/10 HP 125 V, Pilot Duty D300

ANALOG OUTPUT

Type:	isolated, programmable with 12 bits D/A converter, analog output corresponds with displayed data, type and range are adjustable
Non-linearity:	0,1% of range
TC:	15 ppm/°C
Rate:	response to change of value < 1 ms
Voltage:	0...2.5 V/10 V/±10 V
Current:	0...5/20 mA/4...20 mA - compensation of conduct to 500 Ω /12 V or 1 000 Ω/24 V

EXCITATION

Adjustable:	5...24 VDC/max. 1,2 W, isolated
-------------	---------------------------------

POWER SUPPLY

Options:	10...30 V AC/DC, max. 27 VA, isolated PF ≥ 0,4, I _{imp} > 75 A/2 ms fuse inside [T 4A]
	80...250 V AC/DC, max. 27 VA, isolated PF ≥ 0,4, I _{imp} > 475 A/2 ms fuse inside [T 4A]

MECHANIC PROPERTIES

Material:	anodized aluminum, black
Dimensions:	see chapter 12
Panel cut-out:	see chapter 12

OPERATING CONDITIONS

Connection:	through cable bushings to terminal boards inside the instrument, conductor section up to < 1,5 mm ² / < 2,5 mm ²
Stabilisation period:	within 15 minutes after switch-on
Working temp.:	-20°...60°C
Storage temp.:	-20°...85°C
Cover:	IP64
Construction:	safety class I
Overvoltage cat.:	EN 61010-1, A2
Dielectric strength:	4 kVAC after 1 min between supply and input 4 kVAC after 1 min between supply and analog output 4 kVAC after 1 min between supply and relay output 2,5 kVAC after 1 min between supply and analog output
Insulation resist.:	for pollution degree II, measurement category III instrum.power supply > 670 V [PI], 300 V [DI] Input/output > 300 V [PI], 150 [DI]
EMC:	EN 61326-1

* values apply for resistance load

PI - Primary insulation, DI - Double insulation



12. INSTRUMENT DIMENSIONS AND INSTALLATION



Front view

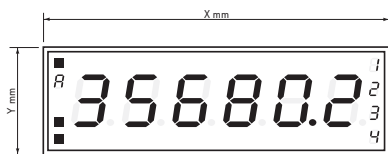

Side view

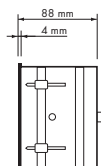

Panel cutout

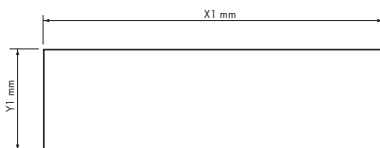

Panel thickness: 0,5 ... 50 mm

Height	X	Y	X1	Y1
57-6	375	119	367	111
100-4	465	181	457	173
100-6	651	181	643	173
125-4	539	237	531	228
125-6	754	237	746	228

Wall mounting

Our large displays are supplied along with a wall mount holder as shown in the the drawing.

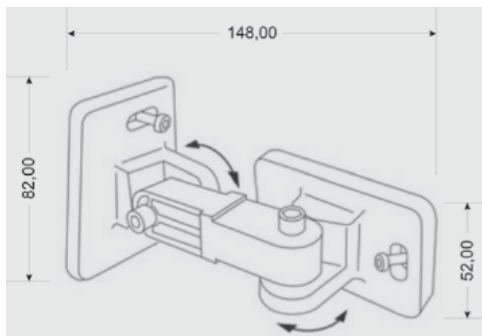



Product **OMD 202RS**
Type
Manufacturing No.
Date of sale

A guarantee period of 60 months from the date of sale to the user applies to this instrument.
Defects occurring during this period due to manufacture error or due to material faults shall be eliminated free of charge.

For quality, function and construction of the instrument the guarantee shall apply provided that the instrument was connected and used in compliance with the instructions for use.

The guarantee shall not apply to defects caused by:

- mechanic damage
- transportation
- intervention of unqualified person incl. the user
- unavoidable event
- other unprofessional interventions

The manufacturer performs guarantee and post-guarantee repairs unless provided for otherwise.

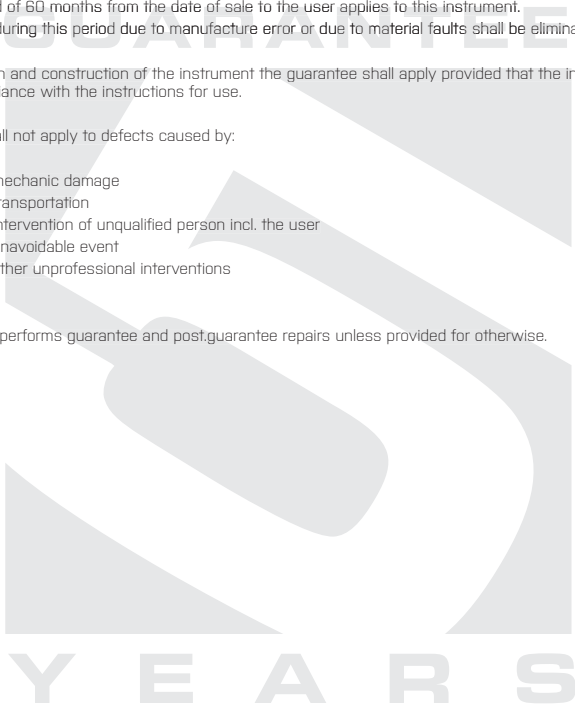

Stamp, signature



Company: **ORBIT MERRET, spol. s r.o.**
Klánova 81/141, 142 00 Prague 4, Czech Republic, IDNo: 00551309

Manufactured: **ORBIT MERRET, spol. s r.o.**
Vodňanská 675/30, 198 00 Prague 9, Czech Republic

declares at its explicit responsibility that the product presented hereunder meets all technical requirements, is safe for use when utilised under the terms and conditions determined by ORBIT MERRET, spol.s r.o. and that our company has taken all measures to ensure conformity of all products of the types referred-to hereunder, which are being brought out to the market, with technical documentation and requirements of the appurtenant Czech statutory orders.

Product: 4/6-digit programmable large display

Type: **OMD 202**

Version: UNI, PWR, UQC, RS

This has been designed and manufactured in line with requirements of:

Statutory order no. 17/2003 Coll., on low-voltage electrical equipment (directive no. 73/23/EHS)
Statutory order no. 616/2006 Coll., on electromagnetic compatibility (directive no. 2004/108/EHS)

The product qualities are in conformity with harmonized standard:

El. safety: EN 61010-1
EMC: EN 61326-1
Electronic measuring, control and laboratory devices – Requirements for EMC "Industrial use"
EN 50131:1, cap. 14 and cap. 15, EN 61000-4-2, EN 61000-4-3, EN 61000-4-4, EN 61000-4-5, EN 61000-4-6, EN 61000-4-8, EN 61000-4-11, EN 61000-3-2, EN 61000-3-3, EN 55022, cap. 5 and cap. 6

The product is furnished with CE label issued in 2001.

As documentation serve the protocols of authorized and accredited organizations:

EMC VTÚE Praha, experimental laboratory No. 1158, protocol No. 08-041/2001 of 24/11/2001
VTÚPV Vyškov, experimental laboratory No. 1103, protocol No. 730-325/2001 of 02/05/2001
VTÚPV Vyškov, experimental laboratory No. 1103, protocol No. 730-350/2001 of 07/05/2001
VTÚPV Vyškov, experimental laboratory No. 1103, protocol No. 730-372/2001 of 02/05/2001
VTÚPV Vyškov, experimental laboratory No. 1103, protocol No. 730-934/2001 of 20/11/2001

Place and date of issue: Prague, 19. Juli 2009

Miroslav Hackl
Company representative

Assessment of conformity pursuant to §22 of Act no. 22/1997 Coll. and changes as amended by Act no.71/2000 Coll. and 205/2002 Coll