



# OMU 408UNI

---

## 4/8 CHANNEL DATA LOGGER

DC VOLTMETER/AMMETER  
PROCESS MONITOR  
OHMMETER  
THERMOMETER FOR PT 100/500/1 000  
THERMOMETER FOR NI 1 000  
THERMOMETER FOR THERMOCOUPLES  
DISPLAY UNIT FOR LIN. POTENTIOMETERS



## SAFETY INSTRUCTIONS

Please, read the enclosed safety instructions carefully and observe them!  
These instruments should be safeguarded by isolated or common fuses (breakers)!  
For safety information the EN 61 010-1 + A2 standard must be observed.  
This instrument is not explosion-safe!

## TECHNICAL DATA

Measuring instruments of the OMU 408 series conform to the European regulation 89/336/EWG and the Ordinance 168/1997 Coll.

The instruments are up to the following European standards:  
EN 55 022, class B  
EN 61000-4-2, -4, -5, -6, -8, -9, -10, -11

Seismic resistance:  
IEC 980: 1993, čl. 6

The instruments are applicable for unlimited use in agricultural and industrial areas.

## CONNECTION

Supply of energy from the main line has to be isolated from the measuring leads.



### ORBIT MERRET, spol. s r.o.

Vodnanska 675/30  
198 00 Prague 9  
Czech Republic

Tel: +420 - 281 040 200  
Fax: +420 - 281 040 299  
e-mail: orbit@merret.cz  
www.orbit.merret.cz



1.	Contents	3
2.	Instrument description	4
3.	Instrument connection	6
4.	Instrument setting	8
	Symbols used in the instructions	10
	Setting the DP and the (-) sign	10
	Control keys function	11
	Setting/permitting items into "USER" menu	11
5.	Setting "LIGHT" menu	12
5.0	Description "LIGHT" menu	12
	Setting input - Type "DC"	16
	Setting input - Type "PM"	18
	Setting input - Type "OHM"	20
	Setting input - Type "RTD - Pt"	22
	Setting input - Type "RTD - Ni"	24
	Setting input - Type "T/C"	26
	Setting input - Type "DU"	28
	Setting input - Type "RTD - Cu"	30
	Setting Limits	32
	Setting analog output	34
	Selection of programming menu „LIGHT"/„PROFI"	36
	Selection of error statement signalization	36
	Restoration of manufacture setting	37
	Calibration - input range (DU)	38
	Selection of instrument menu language version	39
	Setting new access password	39
	Instrument identification	40
6.	Setting "PROFI" menu	42
6.0	Description of "PROFI" menu	42
6.1	"PROFI" menu - INPUT	
6.1.1	Resetting internal values	44
6.1.2	Setting measuring type, range, mode, rate,	45
6.1.3	Setting the Real Time	53
6.1.4	External input function selection	54
6.1.5	Optional accessory functions of the keys	55
6.2	"PROFI" menu - CHANNEL	
6.2.1	Setting measuring parameters (projection, filters, decimal point, description)	60
6.2.2	Setting mathematic functions	65
6.2.3	Selection of evaluation of min/max. value	69
6.3	"PROFI" menu - OUTPUT	
6.3.1	Setting data logging	70
6.3.2	Setting Limits	72
6.3.3	Setting data output	76
6.3.4	Setting analog output	77
6.3.5	Selection of display projection	79
6.4	"PROFI" menu - SERVICE	
6.4.1	Selection of programming menu „LIGHT"/„PROFI"	82
6.4.2	Selection of error statement signalization	83
6.4.3	Restoration manufacture setting	83
6.4.4	Calibration - input range (DU)	84
6.4.5	Selection of instrument menu language version	85
6.4.6	Setting new access password	85
6.4.7	Instrument identification	86
7.	Setting items into "USER" menu	88
8.	Method of measuring of the cold junction	90
9.	Data protocol	92
10.	Error statements	94
11.	Table of symbols	95
12.	Technical data	96
13.	Instrument dimensions and instalation	98
14.	Certificate of guarantee	99

## 2.1 Description

The OMU 408 is a 4/8 channel data logger, designed for maximum purposefulness and user comfort while maintaining its low cost. It is a multifunction instrument with the option of configuration for 8 different types of input, easily configurable in the menu.

The instrument is based on an 8-bit microprocessor with multi-channel 24-bit sigma-delta converter, which ensures the instrument high accuracy, stability and easy operation.

Major advantage of the instrument is with respect to the high rate of sampling on individual channels the feasibility to evaluate all measuring inputs simultaneously.

### The OMU 408UNI is a multifunction instrument available in following types and ranges

<b>DC:</b>	$\pm 60/\pm 150/\pm 300/\pm 1\ 200\ \text{mV}$
<b>PM:</b>	$0\dots 5\ \text{mA}/0\dots 20\ \text{mA}/4\dots 20\ \text{mA}/\pm 2\ \text{V}/\pm 5\ \text{V}/\pm 10\ \text{V}/\pm 40\ \text{V}$
<b>OHM:</b>	$0\dots 100\ \Omega/0\dots 1\ \text{k}\Omega/0\dots 10\ \text{k}\Omega/0\dots 100\ \text{k}\Omega$
<b>RTD-Pt:</b>	Pt 50/100/Pt 500/Pt 1 000
<b>RTD-Cu:</b>	Cu 50/Cu 100
<b>RTD-Ni:</b>	Ni 1 000/Ni 10 000
<b>T/C:</b>	J/K/T/E/B/S/R/N/L
<b>DU:</b>	Linear potentiometer (min. 500 $\Omega$ )

### PROGRAMMABLE PROJECTION

Selection:	of type of input and measuring range
Measuring range:	adjustable as fixed
Setting:	manual, optional projection on the display may be set in the menu for both limit values of the input signal, e.g. input $0\dots 20\ \text{mA} > 0\dots 850,0$
Projection:	-999...9999

### COMPENSATION

of conduct:	in the menu it is possible to perform compensation for 2-wire connection
of conduct in probe:	internal connection (conduct resistance in measuring head)
of CJC (T/C):	manual or automatic, in the menu it is possible to perform selection of the type of thermocouple and compensation of cold junctions, which is adjustable or automatic (temperature at the brackets)

### LINEARIZATION

Linearization:*	by linear interpolation in 254 points (solely via OM Link)
-----------------	--

### DIGITAL FILTERS

Floating average:	from 2...30 measurements
Exponen.average:	from 2...100 measurements
Rounding:	setting the projection step for display

### MATHEMATIC FUCTIONS

Min/max. value:	registration of min./max. value reached during measurement
Tare:	designed to reset display upon non-zero input signal
Peak value:	the display shows only max. or min. value
Mat. operations:	polynome, $1/x$ , logarithm, exponential, power, root, $\sin x$ and mathematic operatin between input - total, divergence, divide

**EXTERNAL CONTROL**

Lock:	control keys blocking
Hold:	display/instrument blocking
Tare:	tare activation/resetting tare to zero
Resetting MM:	resetting min/max value
Memory:	data storage into instrument memory
SWTCH:	switching measuring inputs

**2.2 Operation**

The instrument is set and controlled by five control keys located on the front panel. All programmable settings of the instrument are performed in three adjusting modes:

**LIGHT Simple programming menu**

- contains solely items necessary for instrument setting and is protected by optional number code

**PROFI Complete programming menu**

- contains complete instrument menu and is protected by optional number code

**USER User programming menu**

- may contain arbitrary items selected from the programming menu (LIGHT/PROFI), which determine the right (see or change)  
- access without password

All programmable parameters are stored in the EEPROM memory (they hold even after the instrument is switched off).



Complete instrument operation and setting may be performed via OM Link communication interface, which is a standard equipment of all instruments.

The operation program is freely accessible ([www.orbit.merret.cz](http://www.orbit.merret.cz)) and the only requirement is the purchase of OML cable to connect the instrument to PC. It is manufactured in version RS 232 and USB and is compatible with all ORBIT MERRET instruments. Another option for connection is with the aid of data output RS 232 or RS 485 (without the need of the OML cable).

The program OM LINK in „Basic“ version will enable you to connect one instrument with the option of visualization and archiving in PC. The OM Link „Standard“ version has no limitation of the number of instruments connected.

**2.3 Options**

**Comparators** are assigned to monitor 4 or 8 limit values with relay output. The user may select limits regime: LIMIT/DOSING/FROM-TO. The limits have adjustable hysteresis within the full range of the display as well as selectable delay of the switch-on in the range of 0...99,9 s. Reaching the preset limits is signalled by LED and simultaneously by the switch-on of the relevant relay.

**Data outputs** are for their rate and accuracy suitable for transmission of the measured data for further projection or directly into the control systems. We offer an isolated RS232 and RS485 with the ASCII or DIN MessBus protocol.

**Analog outputs** will find their place in applications where further evaluating or processing of measured data is required in external devices. We offer universal analog output with the option of selection of the type of output - voltage/current. The value of analog output corresponds with the displayed data and its type and range are selectable in Menu.

**Measured data record** is an internal time control of data collection. It is suitable where it is necessary to register measured values. Two modes may be used. FAST is designed for fast storage (40 records/s) of all measured values up to 8 000 records. Second mode is RTC, where data record is governed by Real Time with data storage in a selected time segment and cycle. Up to 250 000 values may be stored in the instrument memory. Data transmission into PC via serial interface RS232/485 and OM link.

The instrument supply leads should not be in proximity of the incoming low-potential signals.

Contactors, motors with larger input power should not be in proximity of the instrument.

The leads into the instrument input (measured quantity) should be in sufficient distance from all power leads and appliances. Provided this cannot be secured it is necessary to use shielded leads with connection to ground (bracket E).

The instruments are tested in compliance with standards for use in industrial area, yet we recommend to abide by the above mentioned principles.

### MEASURING RANGES

Type	Input I	Input U
DC	$\pm 60/\pm 150/\pm 300/\pm 1\ 200$ mV	
PM	0...5/20 mA/4...20 mA/Er.4-20	$\pm 2/\pm 5/\pm 10/\pm 40$ V
OHM	0...0,1/1/10/100 k $\Omega$	
RTD-Pt	Pt 100/Pt 500/ Pt 1 000	
RTD-Cu	Cu 50/100	
RTD-Ni	Ni 1 000/10 000	
T/C	J/K/T/E/B/S/R/N/L	
DU	Linear potentiometer (min. 500 $\Omega$ )	

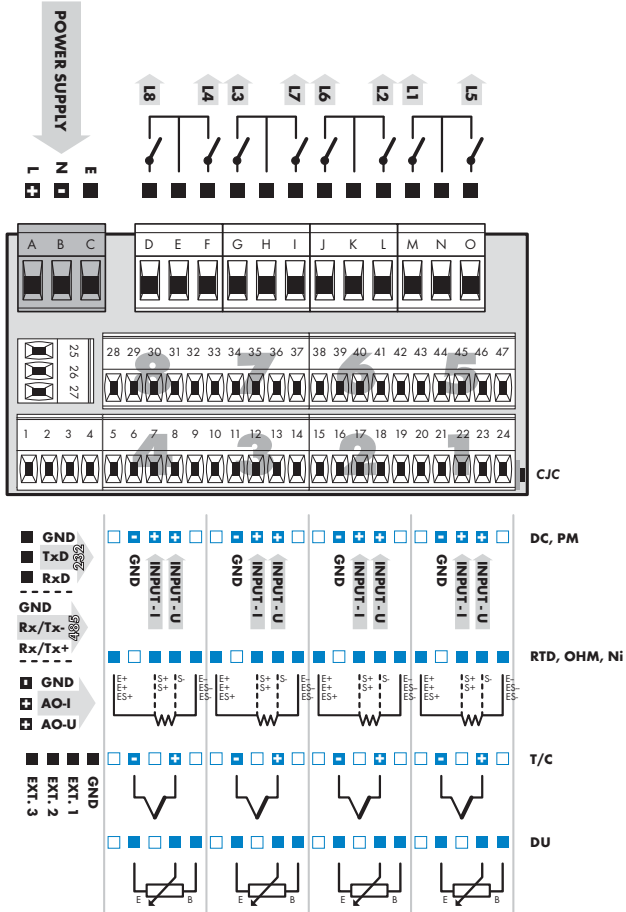

**!**

The inputs do not have galvanic separation among themselves!  
 Maximum difference between the GND brackets is 0,2V - DC, PM, TC, DU  
 (internally connected through resistors 100R)  
 Brackets E - have to be on the same potential - OHM, RTD-Pt, RTD-Ni, RTD-Cu  
 (internal galvanic connection)

PROFI

SETTING

*profi*

LIGHT

SETTING

*light*

USER

SETTING

*profi light**user*

- For expert users
- Complete instrument menu
- Access is password protected
- Possibility to arrange items of the „User“ menu
- Tree menu structure

- For trained users
- Only items necessary for instrument setting
- Access is password protected
- Possibility to arrange items of the „User“ menu
- Linear menu structure

- For user operation
- Menu items are set by the user (Profi/Light) as per request
- Access is not password protected
- Optional menu structure either tree (PROFI) or linear (LIGHT)



## 4.1 Setting

The instrument is set and controlled by five control keys located on the front panel. All programmable settings of the instrument are performed in three adjusting modes:

- LIGHT**      **Simple programming menu**  
 - contains solely items necessary for instrument setting and is protected by optional number code
- PROFI**      **Complete programming menu**  
 - contains complete instrument menu and is protected by optional number code
- USER**      **User programming menu**  
 - may contain arbitrary items selected from the programming menu (LIGHT/PROFI), which determine the right (see or change)  
 - access without password

All programmable parameters are stored in the EEPROM memory (they hold even after the instrument is switched off).

Complete instrument operation and setting may be performed via OM Link communication interface, which is a standard equipment of all instruments.

The operation program is freely accessible ([www.orbit.merret.cz](http://www.orbit.merret.cz)) and the only requirement is the purchase of OML cable to connect the instrument to PC. It is manufactured in version RS 232 and USB and is compatible with all ORBIT MERRET instruments.

Another option for connection is with the aid of data output RS 232 or RS 485 (without the need of the OML cable).

### Scheme of processing the measured signal

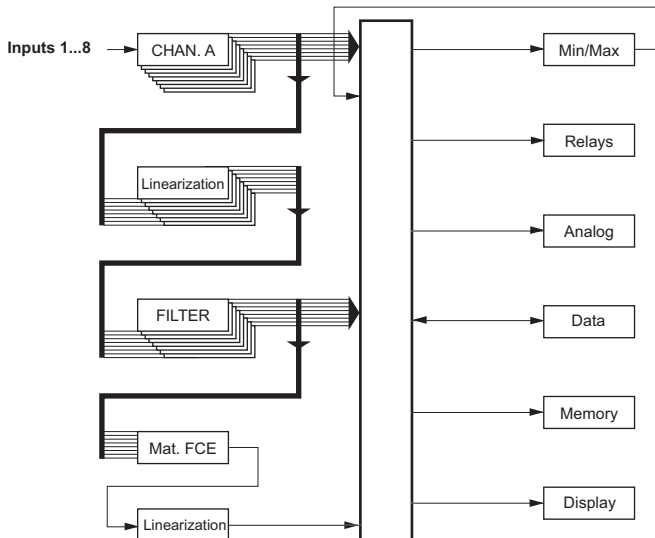

Setting and controlling the instrument is performed by means of 5 control keys located on the front panel. With the aid of these keys it is possible to browse through the operation menu and to select and set required values.

#### Indication of measured input

- red LED by green display
- green LED by red display

#### Function (green LED)

- M Min/max. value
- T Tare



#### Measured value

(red/green LED)

#### Measuring units

(red/green LED)

#### Relay status

(red LED)

- ON the digit is lit
- OFF the digit is not lit
- OFF the digit is flashing > limits with restriction (hysteresis, delay)

### Symbols used in the instructions

**DC** **PM**

**DU** **OHM** **RTD** **T/C** Indicates the setting for given type of instrument

**DEF** values preset from manufacture

symbol indicates a flashing light (symbol)

inverted triangle indicates the item that can be placed in USER menu

broken line indicates a dynamic item, i.e. it is displayed only in particular selection/version

after pressing the key the set value will not be stored

after pressing the key the set value will be stored

**30** continues on page 30

### Setting the decimal point and the minus sign

#### DECIMAL POINT

Its selection in the menu, upon modification of the number to be adjusted it is performed by the control key with transition beyond the highest decade, when the decimal point starts flashing . Positioning is performed by / .

#### THE MINUS SIGN

Setting the minus sign is performed by the key on higher decade. When editing the item subtraction must be made from the current number (e.g.: 013 > , on class 100 > -87)

## Control keys functions

Key	Measurement	Menu	Setting numbers/selection
	access into USER menu	exit menu	quit editing
	programmable key function	back to previous level	move to higher decade
	programmable key function	move to previous item	move down
	programmable key function	move to next item	move up
	programmable key function	confirm selection	confirm setting/selection
			numeric value is set to zero
	access into LIGHT/PROFI menu		
	direct access into PROFI menu		
		configuration of an item for "USER" menu	
		determine the sequence of items in "USER - LIGHT" menu	

## Setting items into „USER“ menu

- in LIGHT or PROFI menu
- no items permitted in USER menu from manufacture
- on items marked by inverted triangle

*user*

*legend is flashing - current setting is displayed*



- item will not be displayed in USER menu
- item will be displayed in USER menu with the option of setting
- item will be solely displayed in USER menu

## 5.0

## Setting "LIGHT"

## LIGHT

## Simple programming menu

- contains only items necessary for instrument setting and is protected by optional number code

SETTING LIGHT

*light*

- For capable users
- Only items necessary for instrument setting
- Access is password protected
- Possibility to arrange items of the „User“ menu
- Linear menu structure

## Preset from manufacture

Password	"0"
Menu	LIGHT
USER menu	off
Setting the items	<b>DEF</b>

!

Upon delay exceeding 60 s the programming mode is automatically discontinued and the instrument itself restores the measuring mode

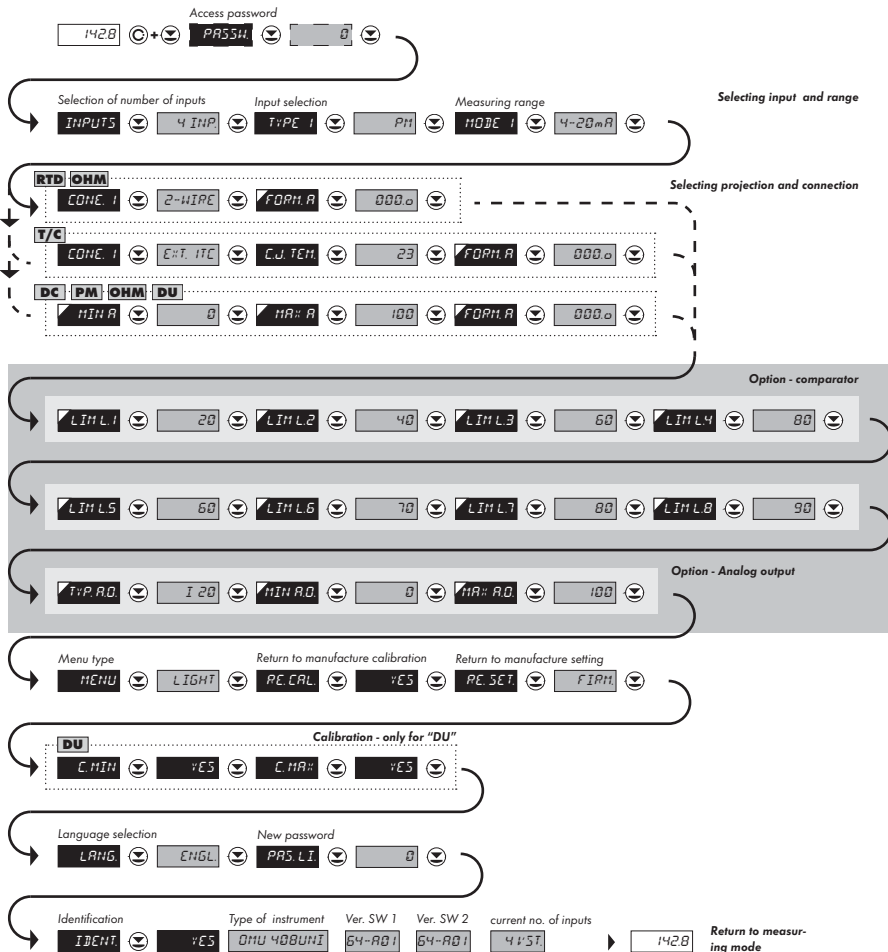

1428



PASSW



0

Entering access password  
for access into the menu



**PASSW** Access into instrument menu

---

**PAS = 0**

- access into menu is unrestricted, after releasing keys you automatically move to first item of the menu

**PAS > 0**

- access into menu is protected by number code

Set "Password" = 42 Example

0	1	2	3	4	5	6	7	8	9	0
32	42	INPUTS								

INPUTS



INP. 1	INP. 2	INP. 3	INP. 4	INP. 5	INP. 6				
INP. 7	INP. 8	2 FAST	3 FAST	4 FAST					

**INPUTS** Selection of number of active measuring inputs of the instrument

- number of active measuring inputs affects the adjustable range of measuring rate
- inputs 5..8 are displayed only in 8-channel version (not in standard version)

- if fast measuring is required (max 40 m/s) option "FAST." may be used, when set number of inputs is active (connected are always only odd inputs 1, 3, 5 or 7)

**DEF** = 4 VST.

4 active inputs

4 INP. TYPE 1

Example



**TYPE 1** Selection of the type of instrument

- primary selection of the type of instrument
- performs default setting **DEF** of values from manufacture, incl. calibration

**DEF** = PM

TYPE 1	Menu	Type of instrument
	DC	DC voltmeter
	PM	Process monitor
	OHM	Ohmmeter
	RTD-Pt	Thermometer for sensors Pt
	RTD-Ni	Thermometer for sensors Ni
	TC	Thermometer for thermocouples
	DU	Display for lin. potentiometer
	RTD-Cu	Thermometer for sensors Cu

**Type "PM"** Example

PH **DEF** 1

Type „DC“	16
Type "PM"	18
Type "OHM"	20
Type "RTD-Pt"	22
Type "RTD-Ni"	24
Type "T/C"	26
Type "DU"	28
Type "RTD-Cu"	30

Type "DC"



**MODE 1** Selection of the instrument measuring range

**DEF** = 60 mV

Menu	Measuring range
60 mV	±60 mV
150 mV	±150 mV
300 mV	±300 mV
1200mV	±1,2 V

Range ±150 mV Example

60 mV | 150 mV | MIN R



**MIN R** Setting display projection for minimum value of input signal

- position of the DP does not affect display projection
- the DP is automatically shifted after the value is confirmed

- range of the setting is -999...9999

**DEF** = 0

Projection for 0 mV > MIN A = 0 Example

0 | -999 | MIN R





**MAX: R** Setting display projection for maximum value of input signal

- position of the DP does not affect display projection
- the DP is automatically shifted after the value is confirmed

- range of the setting is -999...9999

**DEF** = 100

Projection for 150 mV > MAXA = 3500 Example

100	100	100	100	100	100	100
500	500	500	500	500	500	FORN: R

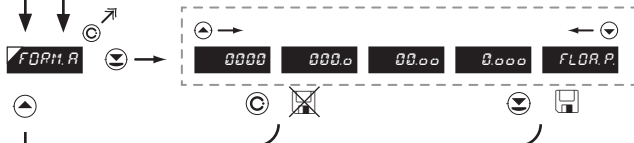

**FORN: R** Setting projection of the decimal point

- positioning of the DP is set here in the measuring mode

**DEF** = 000.0

Projection of DP on display > 0000 Example

0000	000.0	000.0	MECHU
------	-------	-------	-------

\* subsequent item on the menu depends on instrument equipment





**MRA: A** Setting display projection for maximum value of input signal

- position of the DP does not affect display projection
- the DP is automatically shifted after the value is confirmed

- range of the setting is -999...9999

**DEF** = 100

Projection for 20 mA > MAX A = 2500 Example

100	100	100	200	300	400
500	500	500	500	FORM.A	

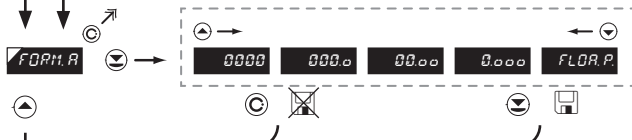

**FORM.A** Setting projection of the decimal point

**DEF** = 000.0

- positioning of the DP is set here in the measuring mode

Projection of DP on display > 0000 Example

000.0	0000	MECH
-------	------	------

\* subsequent item on the menu depends on instrument equipment

Type "OHM"

**MODE 1**

100 R 1 k 10 k 100 k

**MODE 1** Selection of the instrument measuring range

DEF = 100 Ω

MODE 1	Menu	Measuring range
	100 R	0...100 Ω
	1 k	0...1 kΩ
	10 k	0...10 kΩ
	100 k	0...100 kΩ

Range 0...10 kΩ Example

100 R 1 k 10 k CONE. 1

**CONE. 1**

2-WIRE 3-WIRE 4-WIRE

**CONE. 1** Selection of the type of sensor connection

DEF = 2-WIRE

CONE. 1	Menu	Connection
	2-WIRE	2-wire
	3-WIRE	3-wire
	4-WIRE	4-wire

Type of connection - 3-wire > CONE. 1 = 3-WIRE Example

2-WIRE 3-WIRE MIN A

**MIN A**

0 Setting for minimum input signal

**MIN A** Setting display projection for minimum value of input signal

- position of the DP does not affect display projection
- the DP is automatically shifted after the value is confirmed

DEF = 0

Projection for 0 Ohm > MIN A = 0 Example

0 MIN A



**11R: A** Setting display projection for maximum value of input signal

- position of the DP does not affect display projection
- the DP is automatically shifted after the value is confirmed

- range of the setting is -999...9999

**DEF** = 100

Projection for 10 kOhm > MAX A = 1000 Example

100 100 00 000 0000 000

FORH.A

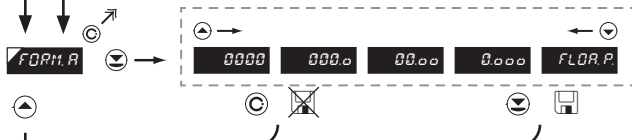

**FORH.A** Setting projection of the decimal point

- positioning of the DP is set here in the measuring mode

**DEF** = 000.0

Projection of DP on display > 0000 Example

000.0 0000 MENU \* subsequent item on the menu depends on instrument equipment

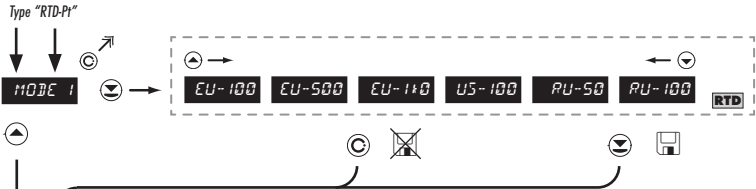

**MODE 1** Selection of instrument measuring range

**DEF** = Pt 100

Menu	Measuring range
EU-100	Pt 100 (3 850 ppm/°C)
EU-500	Pt 500 (3 850 ppm/°C)
EU-1k0	Pt 1000 (3 850 ppm/°C)
US-100	Pt 100 (3 920 ppm/°C)
RU-50	Pt 50 (3 910 ppm/°C)
RU-100	Pt 100 (3 910 ppm/°C)

Range - Pt 1 000 > MODE 1 = EU-1k0 Example

EU-100 EU-500 EU-1k0 CONNE. 1

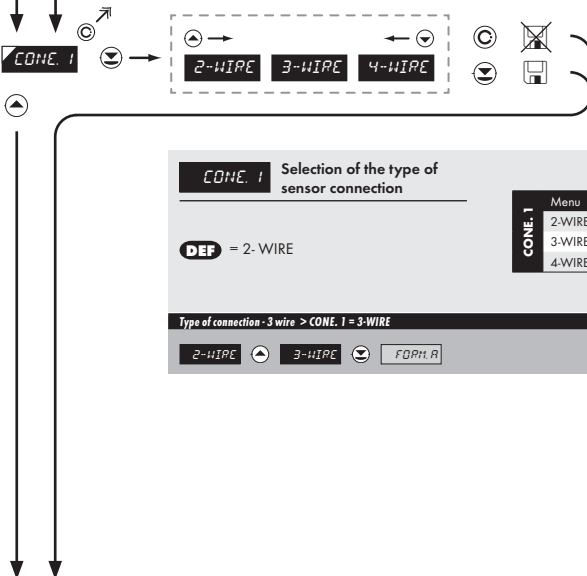



FORM.A

**Setting projection of the decimal point**

DEF = 000.0

- positioning of the DP is set here in the measuring mode

---

**Projection of DP on display > 000.0**

*Example*

000.0

MENU

\* subsequent item on the menu depends on instrument equipment



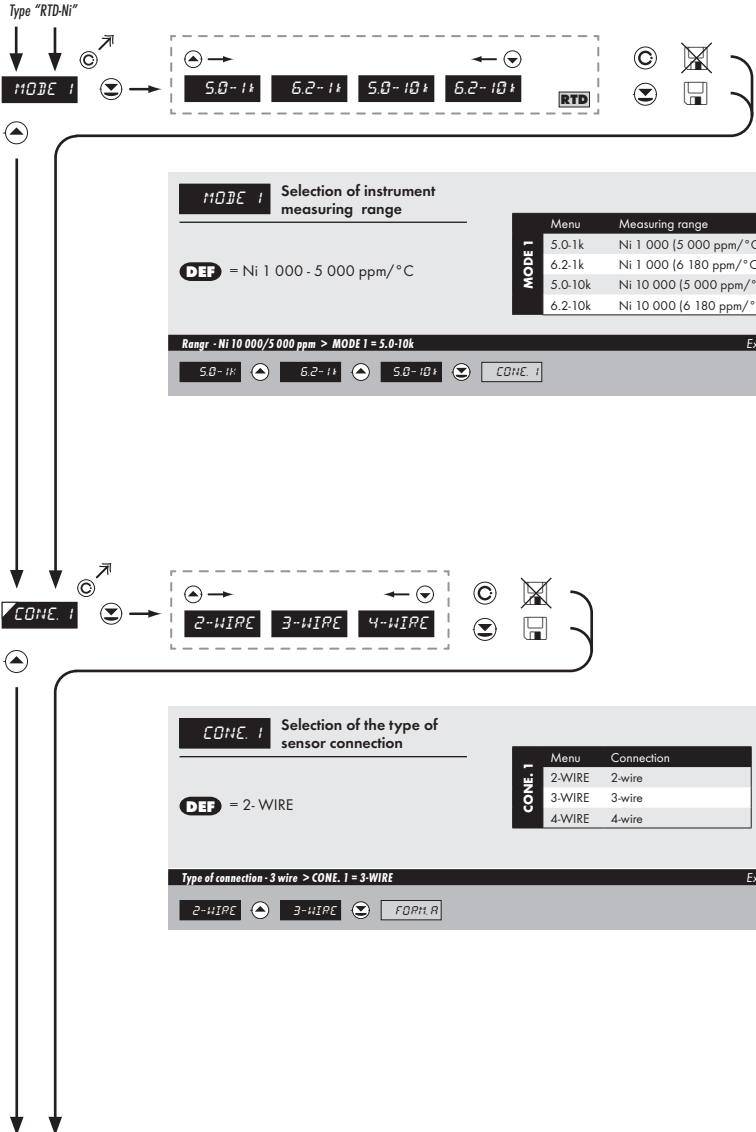





**FORM.A** Setting projection of the decimal point **DEF** = 000.o

- positioning of the DP is set here in the measuring mode

---

**Projection of DP on display > 000o** Example

000.o MENU \* subsequent item on the menu depends on instrument equipment







**C.J. TEM** Setting temperature of cold junction

- range 0...99°C with compensation box

- the item is accessible only when parameters of 1st input are set

**DEF** = 23

---

Setting temperature of cold junction > C.J. TEM. = 35 Example

23 24 25 25 35 FORM.A



**FORM.A** Setting projection of the decimal point

**DEF** = 000.0

- positioning of the DP is set here in the measuring mode

---

Projection of DP on display > 000.0 Example

000.0 1111.1 \* subsequent item on the menu depends on instrument equipment

**!**  
For thermocouple type "B" the items CONE. 1 and C.J. TEM. are not available

**!**  
Method and procedure of setting the cold junctions is described in separate chapter on page 90



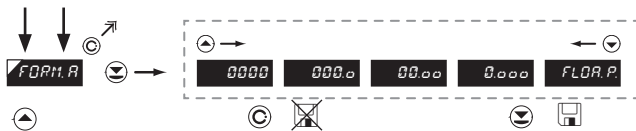

**FORM.A** Setting projection of the decimal point **DEF** = 000.0

- positioning of the DP is set here in the measuring mode

**Projection of DP on display > 0000** Example

000.0 [down arrow] 0000 [down arrow] MENU \* subsequent item on the menu depends on instrument equipment

32

Calibration of the beginning and the end of range of linear potentiometer is on page 38

Type "RTD-Cu"



**MODE 1** Selection of instrument measuring range

**DEF** = 428-50

Menu	Measuring range
428-50	Cu-50 (4 285 ppm/°C)
428-100	Cu 100 (4 285 ppm/°C)
426-50	Cu 50 (4 260 ppm/°C)
426-100	Cu 100 (4 260 ppm/°C)

Range - Cu-50/4 260 ppm > **MODE. 1** = 426-50 Example

428-50 ◀ ▶ 428-0.1 ◀ ▶ 426-50 ◀ ▶ **CONC. 1**



**CONC. 1** Selection of the type of sensor connection

**DEF** = 2-WIRE

Menu	Connection
2-WIRE	2-wire
3-WIRE	3-wire
4-WIRE	4-wire

Type of connection - 3-wire > **CONC. 1** = 3-WIRE Example

2-WIRE ◀ ▶ 3-WIRE ◀ ▶ **FORM. A**



**FORM.A** Setting projection of the decimal point **DEF** = 000.0

- positioning of the DP is set here in the measuring mode

---

**Projection of DP on display > 0000** Example

**000.0** **MENU** \* subsequent item on the menu depends on instrument equipment



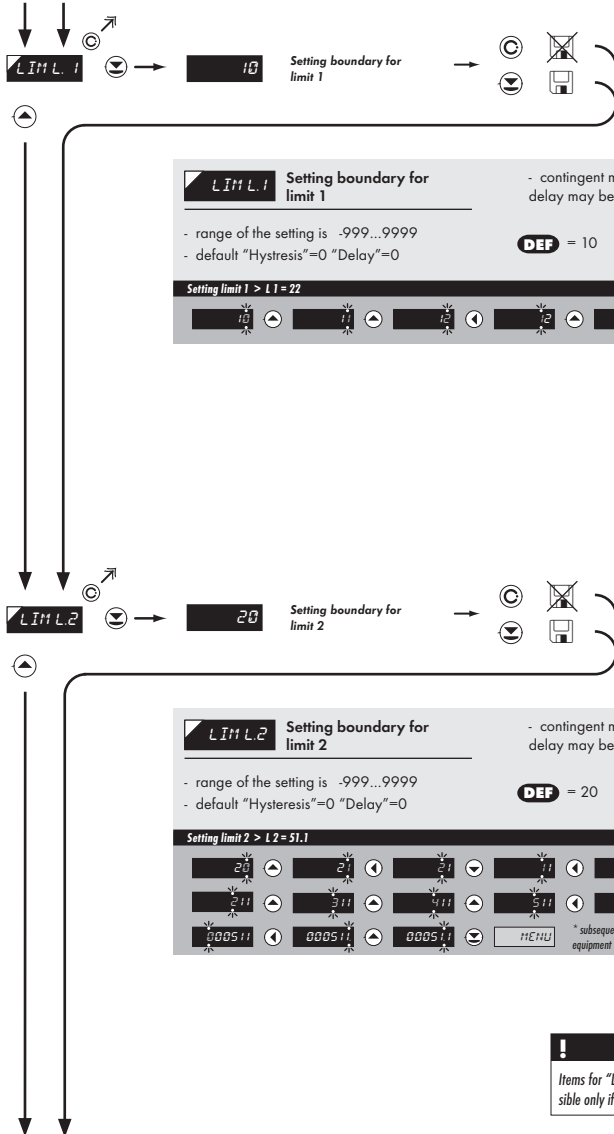

### LIMIT 1 Setting boundary for limit 1

- range of the setting is -999...9999
- default "Hysteresis"=0 "Delay"=0

**DEP** = 10

Setting limit 1 > L1 = 22

Example

10 11 12 12 20 MENU

### LIMIT 2 Setting boundary for limit 2

- range of the setting is -999...9999
- default "Hysteresis"=0 "Delay"=0

**DEP** = 20

Setting limit 2 > L2 = 51.1

Example

20 21 21 11 011 111  
 211 311 411 511 0511 00511  
 000511 000511 000511 MENU

\* subsequent item on the menu depends on instrument equipment

**!**  
 Items for "Limits" and "Analog output" are accessible only if incorporated in the instrument.





**LIM L3** Setting boundary for limit 3

- range of the setting is -.999...9999
- default "Hysteresis"=0 "Delay"=0

**DEF** = 60

---

**Setting limit 3 > L3 = 55** Example

30	31	32	33	34	35
35	45	55	TIME	* subsequent item on the menu depends on instrument equipment	



**LIM L4** Setting boundary for limit 4

- range of the setting is -.999...9999
- default "Hysteresis"=0 "Delay"=0

**DEF** = 80

---

**Setting limit 4 > L4 = 163** Example

40	41	42	43	43	43	53
63	63	63	TIME	* subsequent item on the menu depends on instrument equipment		

**!**  
If instrument with 8 relays was ordered, after setting Limit 4 follows the setting of limits 5...8.

**TYP.A.O.** Setting the type of analog output

Menu	Range	Description
0-20mA	0...20 mA	
E. 4-20mA	4...20 mA	with indication of error statement (<3,6 mA)
4-20mA	4...20 mA	
0.5mA	0...5 mA	
0.2 V	0...2 V	
0.5 V	0...5 V	
0-10 V	0...10 V	

**DEF** = 4...20 mA

Type of analog output - 0...10 V > TYP.A.O. = 0-10 V Example

4-20mA 0-5mA 0-2V 0-5V 0-10V **MIN.A.O.**

**MIN.A.O.** Assigning the display value to the beginning of the AO range

**DEF** = 0

- range of the setting is -999...9999

Display value for the beginning of the AO range > MIN.A.O. = 0 Example

**!**

Items for "Limits" and "Analog output" are accessible only if incorporated in the instrument.

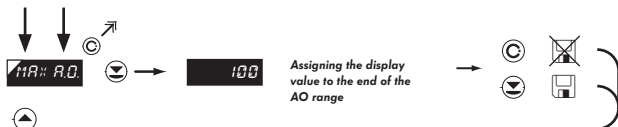

**11A:: R.O.** Assigning the display value to the end of the AO range **DEF** = 100

- range of the setting is -999...9999

**Display value for the end of the AO range > MAX.A.O. = 120** Example

Displayed only with options > **Analog output**

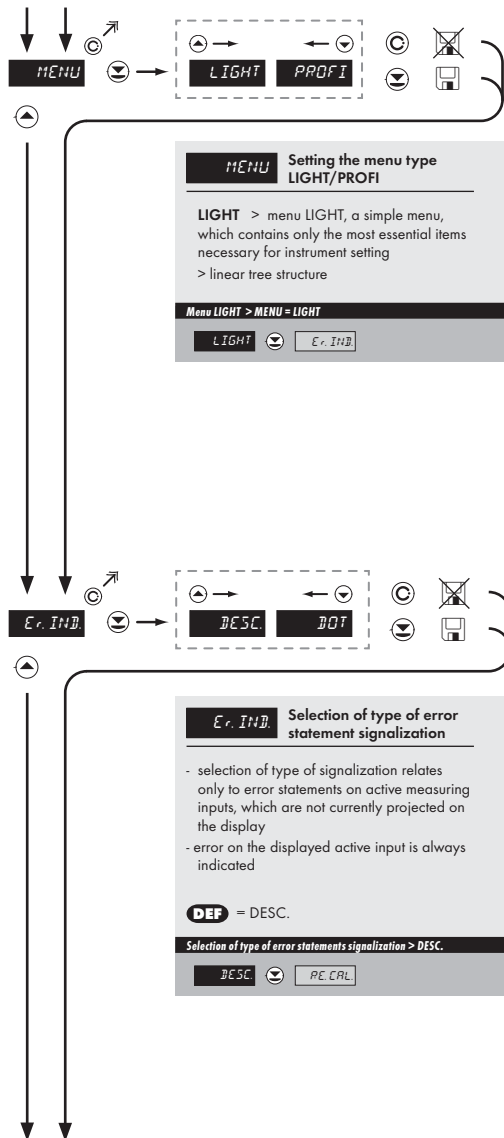

## MENU Setting the menu type LIGHT/PROFI

**LIGHT** > menu LIGHT, a simple menu,  
which contains only the most essential items  
necessary for instrument setting  
> linear tree structure

**PROFI** > menu PROF I, a complete menu for  
complete instrument setting  
> tree menu structure

**DEF** = LIGHT

Menu LIGHT > MENU = LIGHT

Example

LIGHT

Er. IND

## Er. IND. Selection of type of error statement signalization

- selection of type of signalization relates  
only to error statements on active measuring  
inputs, which are not currently projected on  
the display
- error on the displayed active input is always  
indicated

**DEF** = DESC.

Selection of type of error statements signalization > DESC.

Example

DESC.

PE CAL

Menu	Description
<b>Er. IND.</b> DESC.	Error statements are displayed as text on the display of measur- ing units
DOT	Error statement is signalled only by flashing of the decimal point by the indicated channel number



**PE.CAL** Restoration of manufacture calibration

- in the event of error calibration it is feasible to restore manufacture calibration.

Prior to execution of any modifications you will be asked to confirm your selection. (YES)

Restoration of manufacture setting > OB. KAL. Example

PE.CAL ◀ ▶ YES ▶ ◂ ◃ PE.SET

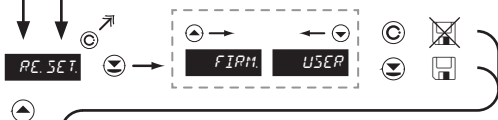

**PE.SET.** Restoration of manufacture instrument setting

- in the event of error setting the manufacture setting may be restored

- restoration is performed for the currently selected type of the instrument input (select "TYPE")

- provided you stored your user setting in the "PROFI" menu, it may also be restored (select "USER")

- loading manufacture calibration and primary setting of items on the menu (DEF)

Restoration of manufacture setting > FIRM. Example

PE.SET ◀ ▶ FIRM. ▶ ◂ ◃ LARG \* subsequent item on the menu depends on instrument type, for "DU" > "C, MIN"

Type „DC“	📖 39
Type "PM"	📖 39
Type "OHM"	📖 39
Type "RTD-Pt"	📖 39
Type "RTD-Ni"	📖 39
Type "T/C"	📖 39
Type "DU"	📖 38
Type "RTD-Cu"	📖 39

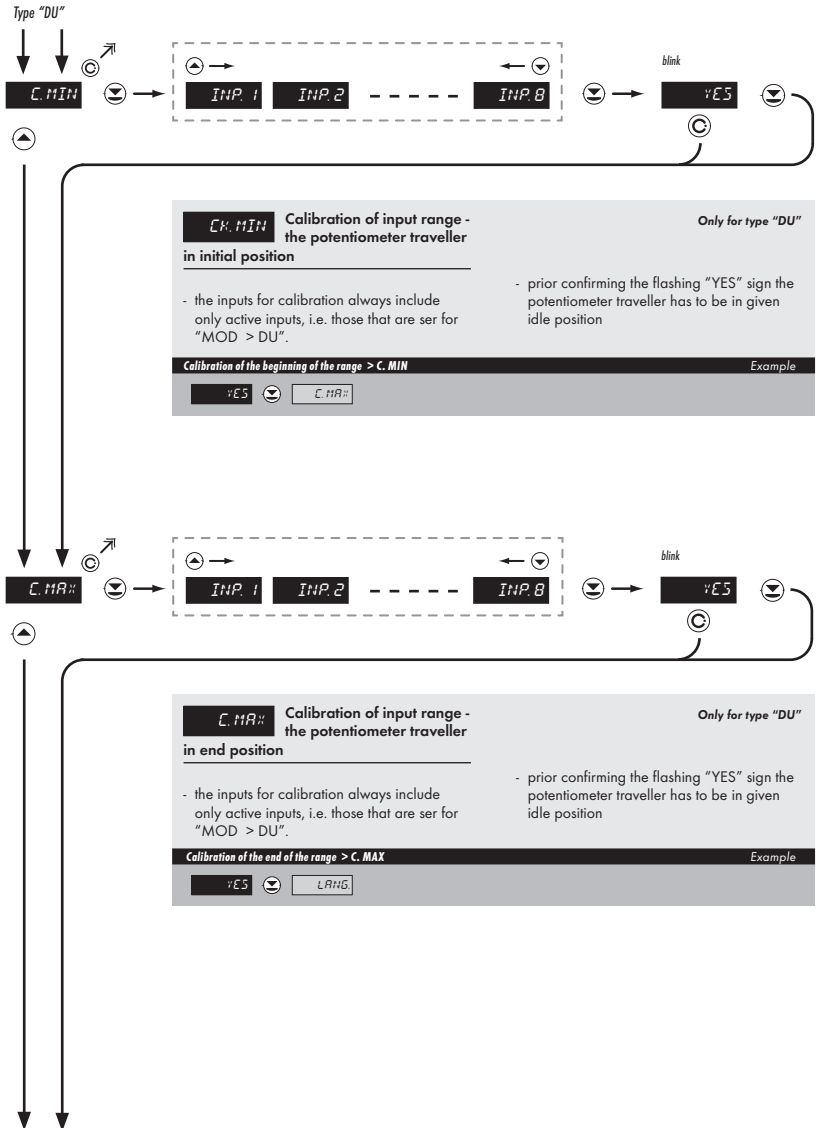

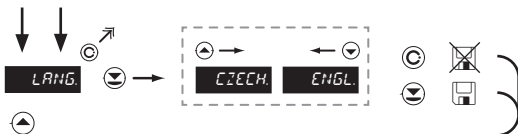

**LANG** Selection of language in instrument menu

- selection of language version of the instrument menu **DEF** = ENG

Language selection - ENGLISH > LANG. = ENGL. Example

CZEŠKY ◀ ANGLIC ▶ PAS.LI



**PAS.LI** Setting new access password

- access password for menu LIGHT  
- range of the number code 0...9999 **DEF** = 0

New password - 341 > PAS.LI. = 341 Example

0 1 2 3 4 5 6 7 8 9

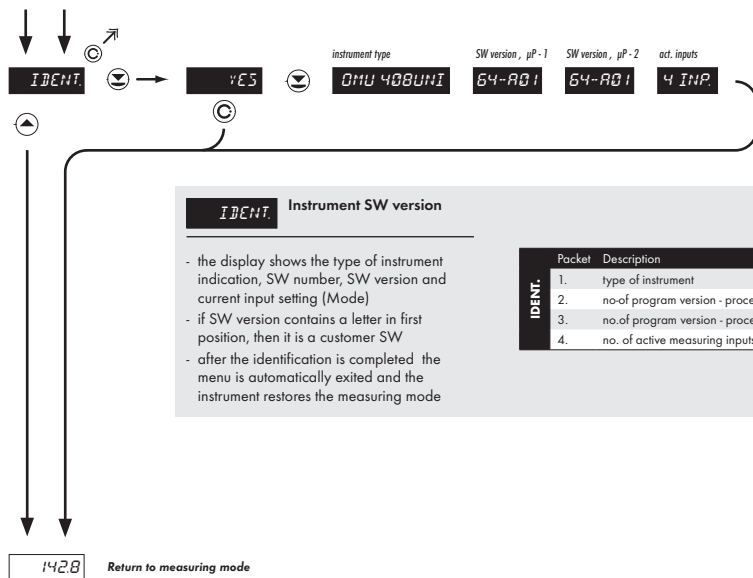





## 6.0

## Setting "PROFI"

## PROFI

## Complete programming menu

- contains complete instrument menu and is protected by optional number code
- designed for expert users
- preset from manufacture is menu **LIGHT**

 PROFIL  
 SETTING

- For expert users
- Complete instrument menu
- Access is password protected
- Possibility to arrange items of the „User“ menu
- Tree menu structure

## Switching over to "PROFI" menu



- temporary switch-over to **PROFI** menu, which is suitable to edit a few items
- after quitting **PROFI** menu the instrument automatically switches to **LIGHT** menu
- access is password protected (if it was not set under item N. PASS. =0)



- access into **LIGHT** menu and transition to item „MENU“ with subsequent selection of „PROFI“ and confirmation
- after re-entering the menu the **PROFI** type is active
- access is password protected (if it was not set under item N. PASS. =0)



## 6.1 Setting "PROFI" - INPUT

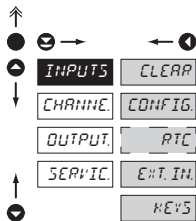

The primary instrument parameters are set in this menu

<b>CLEAR</b>	Resetting internal values
<b>CONFIG</b>	Selection of measuring range and parameters
<b>RTC</b>	Setting date and time for option with RTC
<b>EXT. IN</b>	Setting external inputs functions
<b>KEYS</b>	Assigning further functions to keys on the instrument

## 6.1.1 Resetting internal values

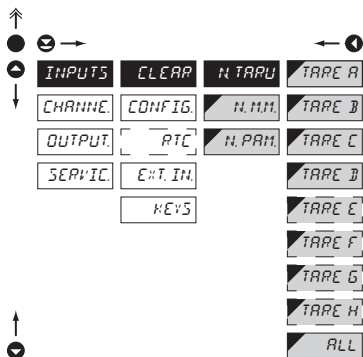
**CLEAR** Resetting internal values

<b>CL.TAR</b>	Tare resetting
- tare resetting may be performed separately for each input or en block for all	
<b>CL.MM</b>	Resetting min/max value
- resetting memory for the storage of minimum and maximum value achieved during measurement	
<b>CL.MEM</b>	Resetting the instrument memory
- resetting memory with data measured in the "FAST" or "RTC" modes	
- not in standard equipment	

#### 6.1.2a Selection of measuring rate

INPUTS	CLEAR	READ/S	40.0
CHANNEL	CONFIG	INPUTS	20.0
OUTPUT	RTC	IN.MOD	10.0
SERVIC.	EXT.IN	SWITCH	5.0
	KEYS	TIM.PR.	2.0
		INP.1	1.0
		INP.2	0.5
		INP.3	0.2
		INP.4	0.1
		INP.5	
		INP.6	
		INP.7	
		INP.8	

READ/S	Selection of measuring rate
40.0	40,0 measurements/s
20.0	20,0 measurements/s
10.0	10,0 measurements/s
5.0	5,0 measurements/s
2.0	2,0 measurements/s
1.0	1,0 measurements/s
0.5	0,5 measurements/s
0.2	0,2 measurements/s
0.1	0,1 measurements/s

#### 6.1.2b Selection of number of active measuring inputs

INPUTS	CLEAR	READ/S	1 INP
CHANNEL	CONFIG	INPUTS	2 INP
OUTPUT	RTC	IN.MOD	3 INP
SERVIC.	EXT.IN	SWITCH	4 INP
	KEYS	TIM.PR.	5 INP
		INP.1	6 INP
		INP.2	7 INP
		INP.3	8 INP
		INP.4	2 FAST
		INP.5	3 FAST
		INP.6	4 FAST
		INP.7	
		INP.8	

INPUTS	Selection of number of active inputs
1 INP	1 active measuring input
...	
4 INP	4 active measuring inputs
5 INP	5 active measuring inputs
...	
8 INP	8 active measuring inputs
2 FAST	2 fast measuring inputs
3 FAST	3 fast measuring inputs
4 FAST	4 fast measuring inputs

- the number of active measuring inputs influences the resulting measuring rate
- inputs 1 and 3 with max. 40 meas./s
- inputs 1, 3 and 5 with max. 40 meas./s
- inputs 1, 3, 5 and 7 with max. 40 meas./s

## 6.1.2c Selection of measuring mode

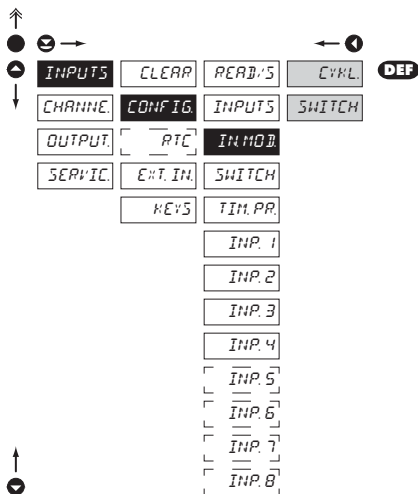
**IN.MOD.** Selection of measuring mode

**CYCL** Cyclic measurement on all inputs

- number of active measuring inputs is set in the INPUTS/CONFIG/OUTPUTS
- projection of measuring inputs is set in the menu INPUTS/CONFIG/SWITCHIN.
- the cycle option rather significantly affects the measuring rate and depends on the number of active inputs (real measuring rates are listed in chapter Technical data)

**SWITCH** Instrument performs measuring only on the active input

- projection of measuring inputs is set in the menu INPUTS/CONFIG/SWITCH.

## 6.1.2d Selection of measuring inputs switching

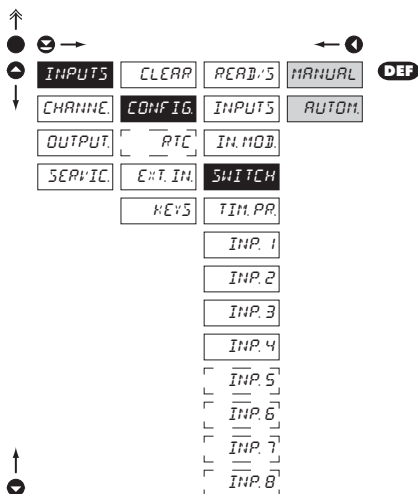
**IN.MOD.** Selection of measuring inputs switching

**MANUAL** Manual inputs switching

- inputs switching is controlled by selected key on the front panel or selected external input

**AUTOM.** Automatic inputs switching

- inputs switching is automatic with time period set in "TIM.SW."

#### 6.1.2e Setting period for measuring inputs switching

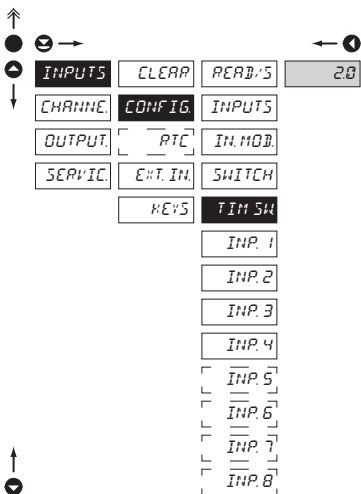

#### TIM SW Setting period for inputs switching

- setting time period for projection of channels in automatic mode of inputs switching ("AUTOM.")
- range of setting 0,5...99,9 s
- **DEF** = 2 s

#### 6.1.2f Selection of „instrument“ type for Input 1

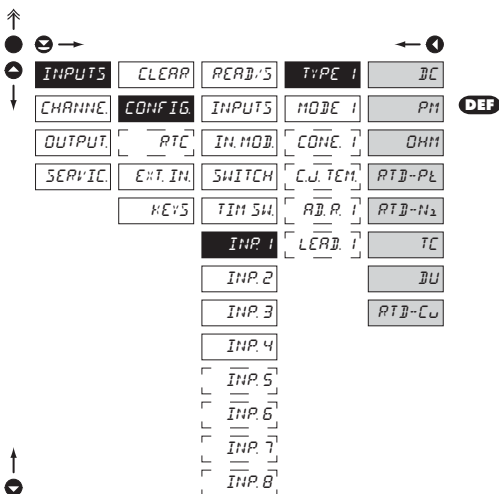

#### TYPE 1 Selection of „instrument“ type for Input 1

- selection of particular type of "instrument" is bound to relevant dynamic items

DC	DC voltmeter
PH	Process monitor
OHM	Ohmmeter
RTD-Pt	Thermometer for Pt xxx
RTD-Ni	Thermometer for Ni xxxx
TC	Thermometer pro thermocouples
BU	Display for linear potentiometers
RTD-Cu	Thermometer for Cu xxx

## 6.1.2g Selection of measuring range for Input 1

↑

← →

↓

<b>INPUTS</b>	CLEAR	READ'S	TYPE 1	DC	60mV	100 P	DEF
CHANNEL	CONFIG	INPUTS	MODE 1		150mV	1 k	
OUTPUT	PTC	INH.MOD	COHE. 1		300mV	10 k	
SERVIC.	EXT.IN	SWITCH	C.J.TEM		1200mV	100 k	
	KEYS	TIM SH	A.D.R.				
		<b>INP 1</b>	LEAD. 1	PM			
		INP 2			0-5mA		
		INP 3			0-20mA		
		INP 4		DEF	4-20mA		
		INP 5			0-2 V		
		INP 6			0-5 V		
		INP 7			0-10 V		
		INP 8			0-40 V		
					Er.4-20		
				RTD-Pt			
				DEF	EU-100	420-50	DEF
					EU-500	420-0.1	
					EU-1k	426-50	
					US-100	426-0.1	
					RU-50		
					RU-100		
				RTD-Cu			
				DEF	420-50		DEF
					420-0.1		
					426-50		
					426-0.1		
				T/C			
					T:°C B		DEF
					T:°C E		
				RTD-Ni	T:°C J		
				DEF	5.0-1k	T:°C K	
					6.2-1k	T:°C N	
					5.0-10k	T:°C P	
					6.2-10k	T:°C S	
				DU	T:°C T		
				DEF	LIN.POT.	T:°C L	

↑

↓

## MODE 1 Selection of instrument measuring range - INP 1

Menu	Measuring range
60 mV	±60 mV
150 mV	±150 mV
300 mV	±300 mV
1200mV	±1.2 V

Menu	Measuring range
0-5mA	0...5 mA
0-20mA	0...20 mA
4-20mA	4...20 mA
0-2 V	±2 V
0-5 V	±5 V
0-10 V	±10 V
0-40 V	±40 V
Er.4-20	4...20 mA, with error statement „underflow“ upon signal smaller than 3,36 mA

Menu	Measuring range
100 R	0...100 Ω
1 k	0...1 kΩ
10 k	0...10 kΩ
100 k	0...100 kΩ

Menu	Measuring range
EU-100	Pt 100 (3 850 ppm/°C)
EU-500	Pt 500 (3 850 ppm/°C)
EU-1k	Pt 1000 (3 850 ppm/°C)
US-100	Pt 100 (3 920 ppm/°C)
RU-50	Pt 50 (3 910 ppm/°C)
RU-100	Pt 100 (3 910 ppm/°C)

Menu	Measuring range
5.0-1k	Ni 1 000 (5 000 ppm/°C)
6.2-1k	Ni 1 000 (6 180 ppm/°C)
5.0-10k	Ni 10 000 (5 000 ppm/°C)
6.2-10k	Ni 10 000 (6 180 ppm/°C)

Menu	Measuring range
428-50	Cu 50 (4 280 ppm/°C)
428-0.1	Cu 1 00 (4 280 ppm/°C)
426-50	Cu 50 (4 260 ppm/°C)
426-0.1	Cu 100 (4 260 ppm/°C)

Menu	Type of thermocouple
T/C B	B
T/C E	E
T/C J	J
T/C K	K
T/C N	N
T/C R	R
T/C S	S
T/C T	T
T/C L	L

\*  
Setting procedure is identical also for inputs 2...8



#### 6.1.2h Selection of type of sensor connection

**RTD OHM T/C**

Navigation icons: Up, Down, Left, Right, Home, Back, Enter.

<b>INPUTS</b>	CLEAR	READ.S	TYPE 1	2-WIRE	<b>DEF</b>
CHANNE	CONFIG	INPUTS	MODE 1	3-WIRE	
OUTPUT	RTC	IN.MOD	CONE. 1	4-WIRE	
SERVIC.	EXT.IN	SWITCH	AD.P. 1		
	KEYS	TIM SW.	LEAD. 1		
		<b>INP 1</b>			
		INP 2			
		INP 3			
		INP 4			
		INP 5			
		INP 6			
		INP 7			
		INP 8			

Navigation icons: Up, Down, Left, Right, Home, Back, Enter.

<b>INPUTS</b>	CLEAR	READ.S	TYPE 1	INT.1TC	<b>DEF</b>
CHANNE	CONFIG	INPUTS	MODE 1	INT.2TC	
OUTPUT	RTC	IN.MOD	CONE. 1	EXT.1TC	
SERVIC.	EXT.IN	SWITCH	C.J. TEM.	EXT.2TC	
	KEYS	TIM SW.			
		<b>INP 1</b>			
		INP 2			
		INP 3			
		INP 4			
		INP 5			
		INP 6			
		INP 7			
		INP 8			

**CONE. 1** Selection of type of sensor connection

**RTD OHM**

2-WIRE 2-wire connection

3-WIRE 3-wire connection

4-WIRE 4-wire connection

**T/C**

**INT.1TC** Measurement without reference thermocouple  
- measuring cold junction at instrument brackets

**INT.2TC** Measurement with reference thermocouple  
- measuring cold junction at instrument brackets with anti-series connected reference thermocouple

**EXT.1TC** Measurement without reference thermocouple  
- the entire measuring set is working under invaried and constant temperature

**EXT.2TC** Measurement with reference thermocouple  
- when using compensation box

**!**  
Setting for "T/C" is accessible only for 1st input

**!**  
Method and procedure of setting the cold junctions is described in separate chapter on page 90

**!**  
For thermocouple type "B" the items CONE. and C.J. TEM. are not available

**\***  
Setting procedure is identical also for inputs 2...8

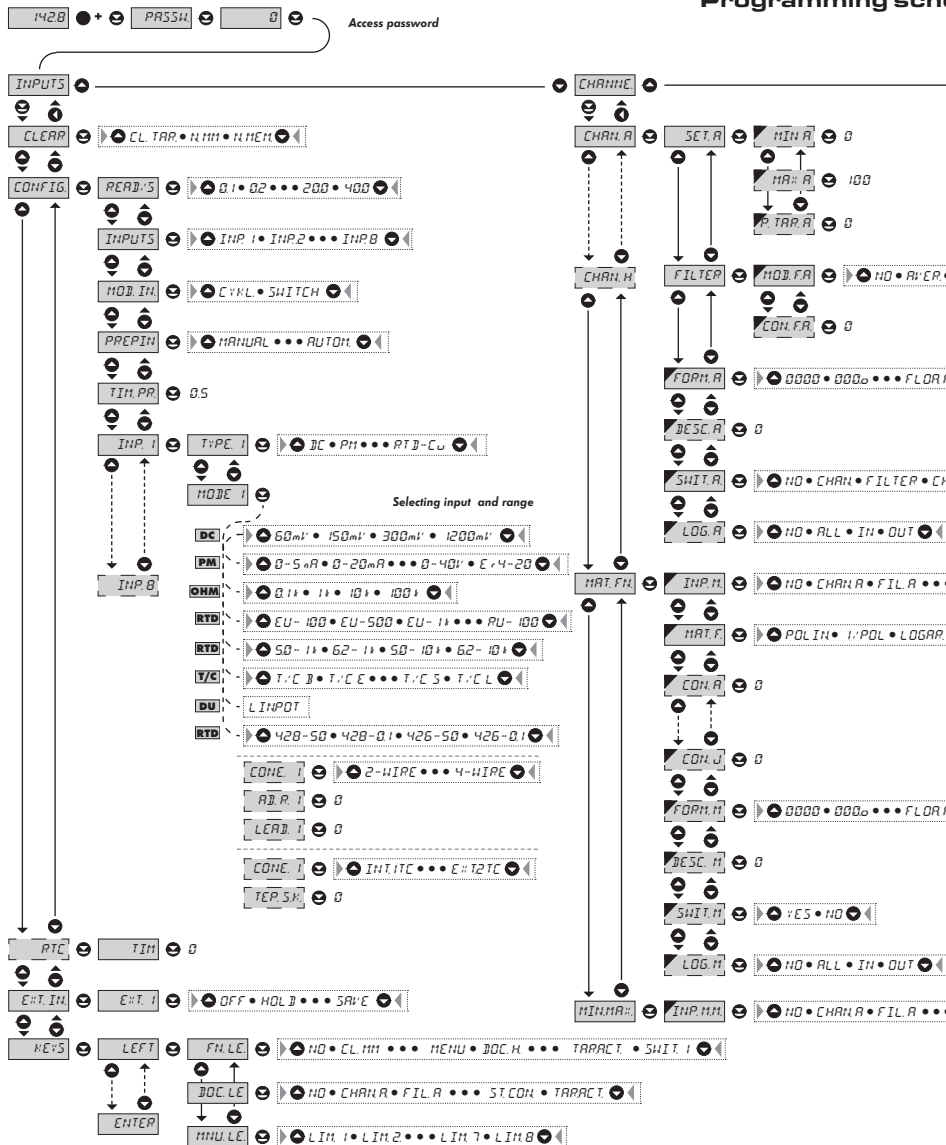

### HOME PROFI MENU

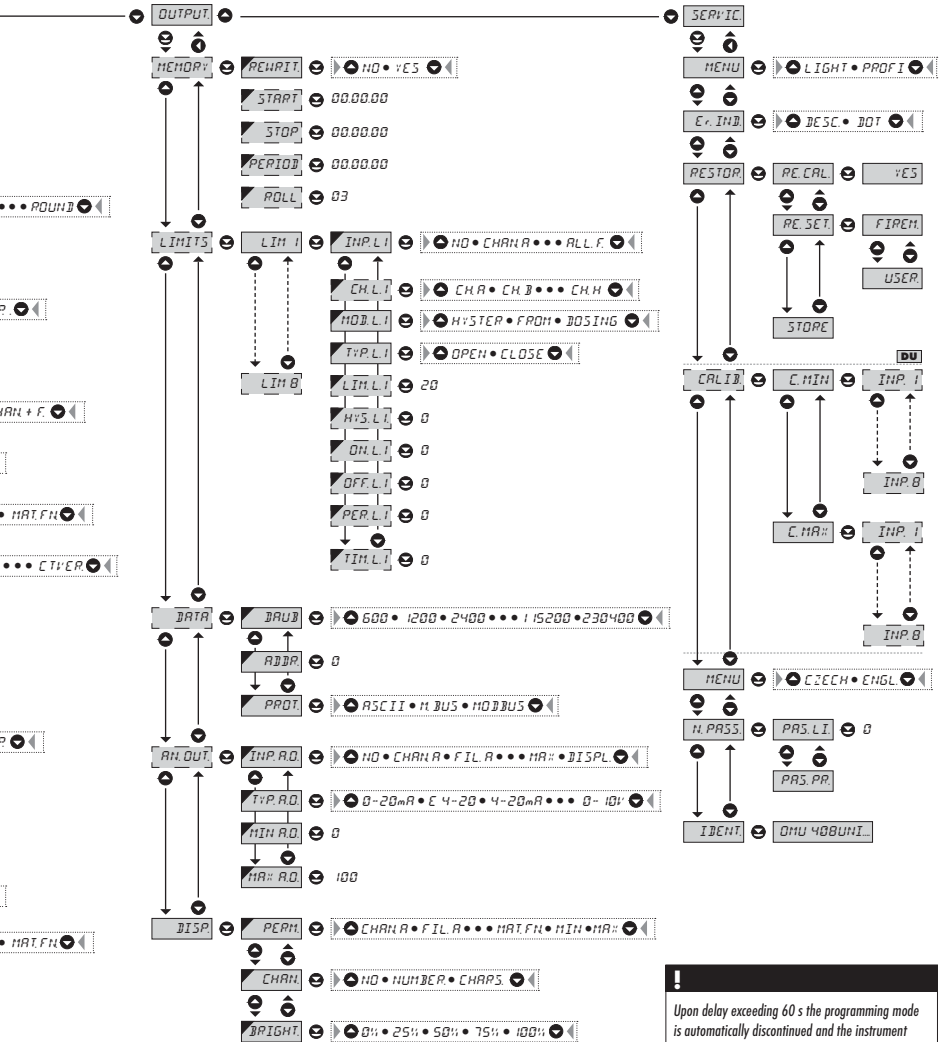

**!** Upon delay exceeding 60 s the programming mode is automatically discontinued and the instrument itself restores the measuring mode

## 6.1.2i Setting temperature of cold junction

T/C

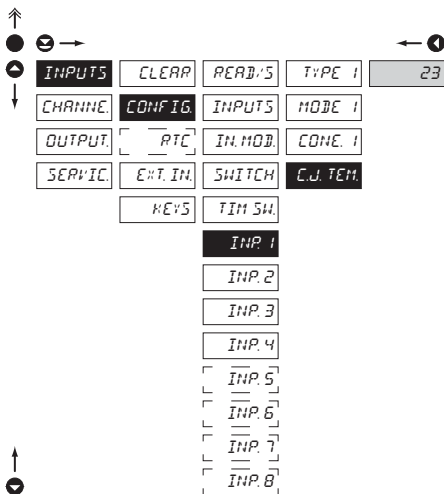

## C.J. TEM. Setting temperature of cold junction

- range 0...99°C with compensation box

- DEF = 23°C

!

Setting for "T/C" is accessible only for 1st input

## 6.1.2j Compensation of 2-wire conduct

RTD OHM

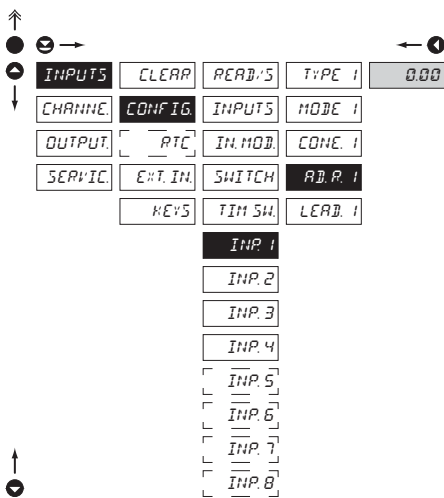

## AD.P. 1 Offset of the beginning of the measuring range

- in cases when it is necessary to offset the beginning of the range by certain value, e.g. while using sensor in measuring head

- entered directly in Ohm (0...9999)

- DEF = 0.00

\*

Setting procedure is identical also for inputs 2...8

#### 6.1.2k Compensation of 2-wire conduct

**RTD** **OHM**

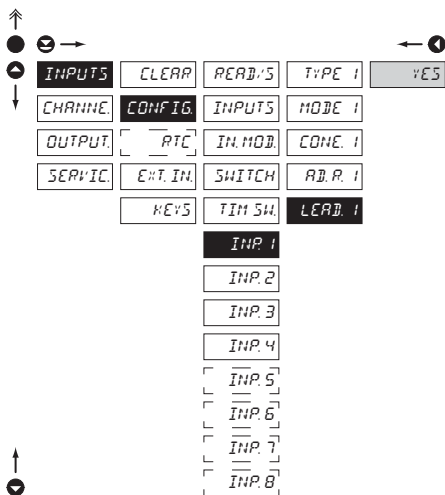

#### LEAD. 1 Compensation of 2-wire conduct

- for measurement accuracy it is necessary to perform compensation of conduct always in case of 2-wire connection
- prior confirmation of the displayed prompt „YES“ it is necessary to substitute the sensor at the end of the conduct by a short-circuit
- **DEF** = 0

\*

Setting procedure is identical also for inputs 2...8

#### 6.1.3 Setting the real time clock

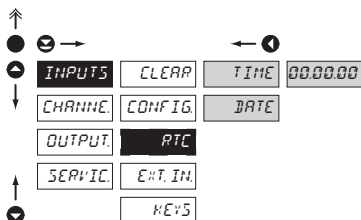

#### RTC Setting the real time clock (RTC)

**TIME** Time setting

- format 23.59.59

**DATE** Date setting

- format DD.MM.YY

## 6.1.4a External input function selection

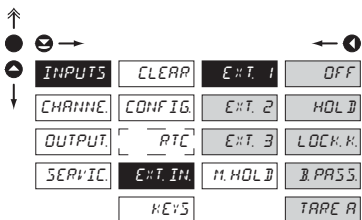
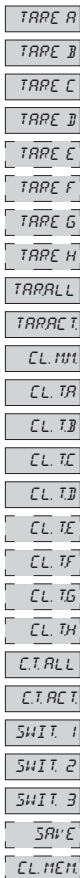

Table with external inputs control

Kanál	Ext 1	Ext 2	Ext 3
FIL. A	0	0	
FIL. B	0	1	
FIL. C	1	0	
FIL. D	1	1	
FIL. E	0	0	1
FIL. F	0	1	1
FIL. G	1	0	1
FIL. H	1	1	1



**EXT. IN.** External input function selection

- OFF** Input is off
- HOLD** Activation of HOLD
- LOCK K.** Locking keys on the instrument
- B. PASS.** Activation of locking access into programming menu LIGHT/PROFI
- TARE -** Tare activation > by individual inputs
- TAPALL** Tare activation on all channels
- TAPACT.** Tare activation on current input
- CL.MM** Resetting min/max value
- CL. T.-** Clear tare > by individual inputs
- C.T.ALL** Clear tare on all channels
- C.T.ACT.** Clear tare on current input
- SWIT. 1** Gradual switching of inputs projection
- SWIT. 2** BCD switching of inputs projection - Ext 1, 2  
- control see table  
- after this choice the setting for „EXT.2“ is automatically disabled
- SWIT. 3** BCD switching of inputs projection - Ext 1, 2  
- control see table  
- after this choice the setting for „EXT.2“ and „EXT. 3“ is automatically disabled
- SAVE** Activation of recording of measured data into instrument memory (not a standard option)
- CL.MEM.** Clears data and starts initialization (FAST RTC)
  - **DEF** EXT. 1 > HOLD
  - **DEF** EXT. 2 > LOCK
  - **DEF** EXT. 3 > SWIT. 1

\*

Setting procedure is identical for EXT. 2 and EXT. 3

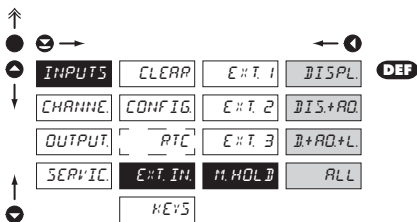
#### 6.1.4b Selection of function "HOLD"



#### M.HOLD Selection of function "HOLD"

- DISPL.** "HOLD" locks only the value displayed
- DIS+AD.** "HOLD" locks the value displayed and on AO
- D+AD+L.** "HOLD" locks the value displayed, on AO and limit evaluation
- ALL** "HOLD" locks the entire instrument

#### 6.1.5a Optional accessory functions of the keys

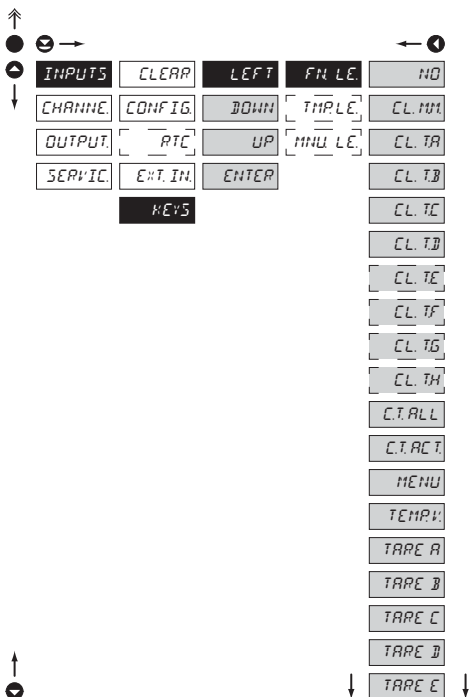

#### FN.LE. Assigning further functions to inst. keys

- „FN.LE.“ > executive functions
  - „TMP.LE.“ > temporary projection of selected values
  - „MNU.LE.“ > direct access into menu on selected item
- NO** Key has no further function
  - CL.MN.** Resetting min/max value
  - CL.T-.** Clear tare > by individual inputs
  - CL.ALL** Clear tare on all channels
  - CL.ACT.** Clear tare on current input
  - MENU** Direct access into menu on selected item
- after confirmation of this selection the "MNU.LE." item is displayed on superior menu level, where required selection is performed
  - TEMP.V.** Temporary projection of selected values
  - after confirmation of this selection the item "TMP.LE." is displayed on superior menu level, where required selection is performed
  - TARE -** Tare activation > by individual inputs



TARE F	Tare activation on all channels
TARE G	Tare activation on current input
TARE H	Tare activation on current input
TAPALL	Gradual switching of inputs projection - UP
TAPACT	Gradual switching of inputs projection - DOWN
SHIT. I	Gradual switching of inputs projection - UP
SHIT. - I	Gradual switching of inputs projection - DOWN
SAVE	Activation of recording of measured data into instrument memory (not a standard option)
CL.MEM	Clears data and starts initialization (FAST RTC)

### 6.1.5b Optional accessory functions of the keys - Temporary projection

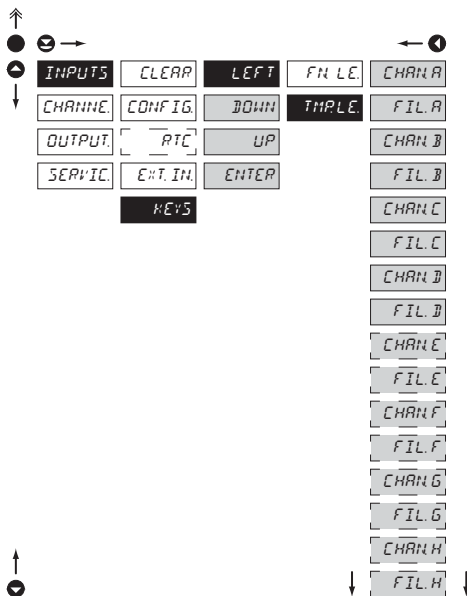

#### TMPL.E Temporary projection of selected item

- "Temporary" projection of selected value is displayed for the time of keystroke
- "Temporary" projection may be switched to permanent by pressing ● + "Selected key", this holds until the stroke of any key

CHAN. -	Temporary projection of value input/channel
FIL. -	Temporary projection of value input/channel after digital filter processing

- selection from "Temporary" projection of input A, B, C, D, E, F, G, H
- selection from "Temporary" projection of filtered input A, B, C, D, E, F, G, H

**!**  
Setting is identical for LEFT, DOWN, UP and ENTER



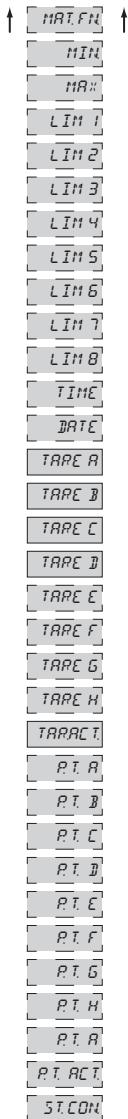

- MAT.FIN** Temporary projection of value "Mathematic funtion"
- MIN** Temporary projection of value "Min. value"
- MAX** Temporary projection of value "Max. value"
- LIM 1** Temporary projection of value "Limits"
- LIM 2** - selection from "Temporary" projection Limits 1, 2, 3, 4, 5, 6, 7, 8
- LIM 3**
- LIM 4**
- LIM 5**
- LIM 6**
- LIM 7**
- LIM 8**
- TIME** Temporary projection of "TIME" value
- DATE** Temporary projection of "DATE" value
- TARE -** Temporary projection of "TARE" value
- selection from "Temporary" projection Tare fir input A, B, C, D, E, F, G, H
- TARRACT** Temporary projection of value "TARE"
- "Temporary" projection of Tare for currently selected type
- P.TAR.A** Temporary projection of value "P. TAR. A"
- selection from "Temporary" projection of "Fixed tare" for inp. A, B, C, D, E, F, G, H
- P.T.ACT.** Temporary projection of value "P. T. ACT."
- "Temporary" projection of "Fixed tare" for currently selected input
- ST.COM.** Temporary projection of "CJC" value



Setting is identical for LEFT, DOWN, UP and ENTER



Preset values of the control keys **DEF**:

LEFT	displays Input B
UP	displays Input C
DOWN	displays Input D
ENTER	Input switching - UP

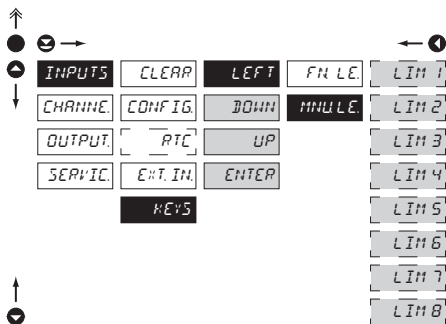
**6.1.5c Optional accessory functions of the keys - Direct access to item**

**MNU LE** Assigning access to selected menu item

- LIM 1** Direct access to item "LIM 1"
- LIM 2** Direct access to item "LIM 2"
- LIM 3** Direct access to item "LIM 3"
- LIM 4** Direct access to item "LIM 4"
- LIM 5** Direct access to item "LIM 5"
- LIM 6** Direct access to item "LIM 6"
- LIM 7** Direct access to item "LIM 7"
- LIM 8** Direct access to item "LIM 8"

**!** Setting is identical for LEFT, DOWN, UP and ENTER

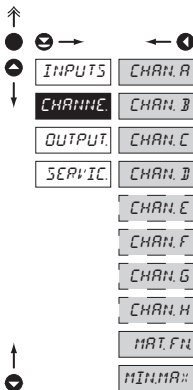

## 6.2 Setting "PROFI" - CHANNELS



The primary instrument parameters are set in this menu

- CHAN.A** Setting parameters of measuring "Channel"  
- selection from inputs A, B, C, D, E, F, G, H
- MAT.FN** Setting parameters of mathematic functions
- MIN.MA::** Selection of access and evaluation of Min/max value

## 6.2.1a Display projection

DC PM DU OHM

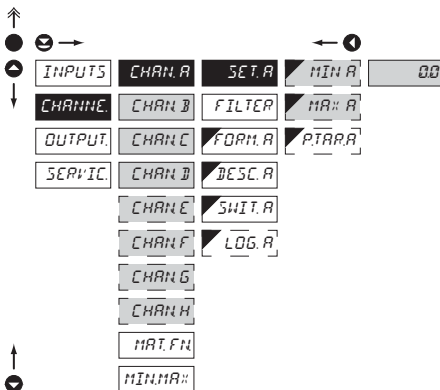
**SET.A** Setting display projection - Input A

**MIN.A** Setting display projection for minimum value of input signal  
- range of the setting is -999...9999  
- **DEF** = 0

**MA::A** Setting display projection for maximum value of input signal  
- range of the setting is -999...9999  
- **DEF** = 100



Setting is identical for input B, C, D, E, F, G, H

#### 6.2.1b Setting fixed tare

**DC** **PM** **DU** **OHM**

INPUTS	CHAN A	SET A	MIN A	00
CHANNE	CHAN B	FILTER	MA: A	
OUTPUT	CHAN C	FORM A	PTARA	
SERVIC	CHAN D	BESC A		
	CHAN E	SWIT A		
	CHAN F	LOG A		
	CHAN G			
	CHAN H			
	MAT FN			
	MINMA:			

#### P.TARA Setting "Fixed tare" value

- setting is designed for the event when it is necessary to firmly shift the beginning of the range by known size
- when setting (P.TAR. A > 0) display shows "T" symbol
- range of the setting is 0...9999
- **DEF** = 0



Setting is identical for input B, C, D, E, F, G, H

## 6.2.1c Digital filters

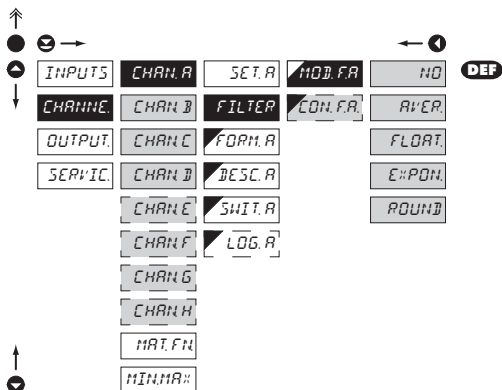
**MOD.FA** Selection of digital filters

- at times it is useful for better user projection of data on display to modify it mathematically and properly, wherefore the following filters may be used:

**NO** Filters are off

**AVER** Measured data average

- arithmetic average from given number („CON.F.A.“) of measured values
- range 2...100

**FLOAT** Selection of floating filter

- floating arithmetic average from given number („CON.F.A.“) of measured data and updates with each measured value
- range 2...30

**EXPON** Selection of exponential filter

- integration filter of first prvnho grade with time constant („CON.F.A.“) measurement
- range 2...100

**ROUND** Measured value rounding

- is entered by any number, which determines the projection step (e.g. „CON.F.A.“=2,5 > display 0, 2,5, 5,...)

**CON.F.A.** Setting constants

- this menu item is always displayed after selection of particular type of filter
- **DEF** = 2



Setting is identical for input B, C, D, E, F, G, H

#### 6.2.1d Projection format - positioning of decimal point

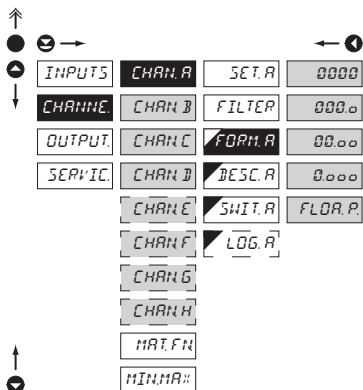

#### FORM.A Selection of decimal point

- the instrument allows for classic projection of a number with positioning of the DP as well as projection with floating DP, allowing to display a number in its most exact form „FLOAT.P.“

0000 Setting DP - XXXX

000.0 Setting DP - XXX.x

**DEF**  
00.00 Setting DP - XX.xx

0.000 Setting DP - X.xxx

FLOA.P. Floating DP



Setting is identical for input B, C, D, E, F, G, H

#### 6.2.1e Projection of description - the measuring units

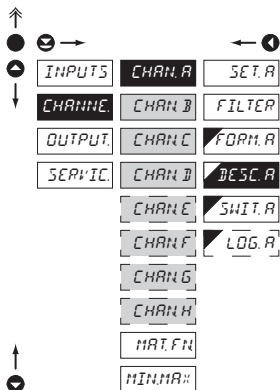

#### BES.C.A Setting projection of descrpt. for "Channel A"

- projection of measured data may be extended (at the expense of the number of displayed places) by two characters for description

- description is set by shifted ASCII code, when two first places show the set description and two last characters their code in period 0...95

- description is cancelled by code 00

- **RTD** / **T/C** **DEF** = °C

- **DC** / **PM** / **DU** / **OHM** **DEF** = none



Table of signs on page 95

**6.2.1f Selection of channel projection upon switching**

Setting is identical for input B, C, D, E, F, G, H

**SWIT.A Selection of channel projection upon switching**

- setting in this item allows the user to choose individual measuring channels, which will be projected upon channel switching through function „SWITCH. A“

NO	Projection prohibited
CHANNE	“Channel A” will be projected
FILTER	“Channel A” will be projected after digital filter modification
CHAN.+F.	“Chanel A” will be projected and subsequently also “Channel A” after digital filter modification

**6.2.1g Selection of storing data into instrument memory**

Setting is identical for input B, C, D, E, F, G, H

**LOG.A Selection of storing data into instrument memory**

- by selection in this item you allow to register values into instrument memory
- another setting in item “OUTPUT. > MEMORY” (not in standard equipment)

NO	Measured data are not stored
ALL	Measured data are stored in memory
IN	Only data measured within the set interval are stored in memory
OUT	Only data measured outside the set interval are stored in memory
FROM A	Setting the initial value of interval
- range f setting: -999...9999	
TO A	Setting the final value of interval
- range of setting: -999...9999	



#### 6.2.2a Mathematic function - input selection

INPUTS	CHAN A	<b>INP.M</b>	NO	
<b>CHANNE</b>	CHAN B	MATH.F	FIL A	<b>DEF</b>
OUTPUT	CHAN C	CON A	FIL B	
SEPV:IC	CHAN D	CON B	FIL C	
	CHAN E	CON C	FIL D	
	CHAN F	CON D	FIL E	
	CHAN G	CON E	FIL F	
	CHAN H	CON F	FIL G	
MATH.FN	CON G	FIL H		
MIN:MA#	CON H	ALL.F		
	CON I			
	CON J			
	FORM.M			
	BESC.M			
	SWIT.M			
	LOG.M			

**INP.M** Selection of input for calculation of mat. function

- selection of value from which the mathematic function will be calculated

**NO** Mathematic functions are off

**FIL A** From "input/channel A" after digital filter modification

**FIL B** From "input/channel B" after digital filter modification

**FIL C** From "input/channel C" after digital filter modification

**FIL D** From "input/channel D" after digital filter modification

**FIL E** From "input/channel E" after digital filter modification

**FIL F** From "input/channel F" after digital filter modification

**FIL G** From "input/channel G" after digital filter modification

**FIL H** From "input/channel H" after digital filter modification

**ALL.F** From all inputs/channels after digital filter modification

## 6.2.2b Mathematic functions

↑  
 ● →  
 ▲  
 ↓

INPUTS	CHAN. A	INP. M.	MULTIN	DEF
CHANNE	CHAN. B	MATH. F.	I·MUL	
OUTPUT	CHAN. C	CON. A	LOGARR	
SERVIC.	CHAN. D	CON. B	E:POW.	
	CHAN. E	CON. C	POWER	
	CHAN. F	CON. D	ROOT	
	CHAN. G	CON. E	SIN #	
	CHAN. H	CON. F		
MAT.FM	CON. G			
MIN.MA#	CON. H	SUMA	DEF	
	CON. I	DIVIDE		
	CON. J	QUADER		
	FOPM.H			
	BESC.H			
	SWIT.M			
	LOG.H			

↑  
 ●

**MATH. F.** Selection of mathematic functions

In selecting „FIL. -“ in item „INP. M.“

**MULTIN** Polynome

$$Ax^2 + Bx^3 + Cx^4 + Dx^5 + Ex + F$$

**I·MUL**  $1/x$ 

$$\frac{A}{x^3} + \frac{B}{x^4} + \frac{C}{x^3} + \frac{D}{x^2} + \frac{E}{x} + F$$

**LOGARR** Logarithm

$$A \times \ln\left(\frac{Bx+C}{Dx+E}\right) + F$$

**E:POW.** Exponential

$$A \times e^{\left(\frac{Bx+C}{Dx+E}\right)} + F$$

**POWER** Power

$$A \times (Bx+C)^{(Dx+E)} + F$$

**ROOT** Root

$$A \times \sqrt{\frac{Bx+C}{Dx+E}} + F$$

**SIN #** Sin x

$$A \sin^3 x + B \sin^4 x + C \sin^3 x + D \sin^2 x + E \sin x + F$$

In selecting „ALL. F.“ in item „INP. M.“

**SUMA** Total of values from channels (inputs)  
 $(A \times KA + B \times KB + C \times KC + D \times KD + G \times KE + H \times KF + I \times KG + J \times KH) \times E + F$ 
**DIVIDE** Channels (inputs) values division  
 $(A \times KA + C \times KC + G \times KE + J \times KJ) / (B \times KB + D \times KD + H \times KF + J \times KH) \times E + F$ 
**QUADER.** Product of channels (inputs) values  
 $(A \times KA^2 + B \times KB^2 + C \times KC^2 + D \times KD^2 + G \times KE^2 + H \times KF^2 + I \times KG^2 + J \times KH^2) \times E + F$ 
**CON. -** Setting constants for calculation of mat. fce.  
 - this menu is displayed only after selection of given mathematic function

#### 6.2.2c Mathematic functions - decimal point

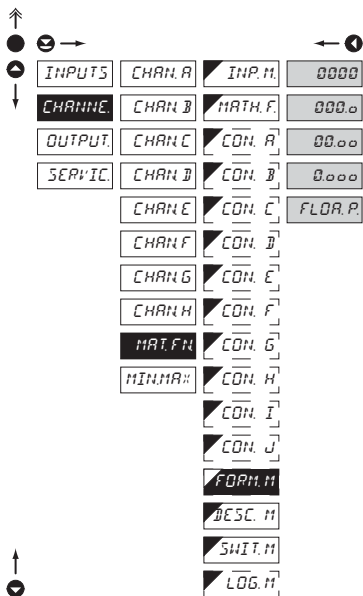

#### FORM.M Selection of decimal point

- the instrument allows for classic projection of a number with positioning of the DP as well as projection with floating DP, allowing to display a number in its most exact form „FLOA.P.“

0000	Setting DP - XXXX
000.0	Setting DP - XXX.x
00.00	Setting DP - XX.xx
0.000	Setting DP - X.xxx
FLOA.P.	Floating DP

**DEF**

#### 6.2.2d Mathematic functions - measuring units

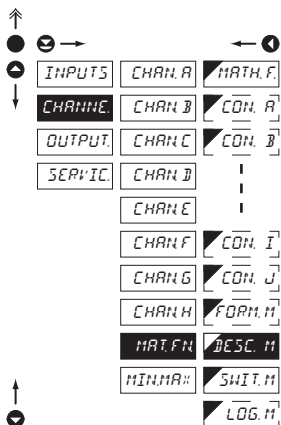

#### DESC.M Setting projection of description for "MAT.FN"

- projection of measured data may be extended (at the expense of the number of displayed places) by two characters for description
- description is set by shifted ASCII code, when two first places show the set description and two last characters their code in period 0...95
- description is cancelled by code 00
- **DEF** = no description

**!**

Table of signs on page 95

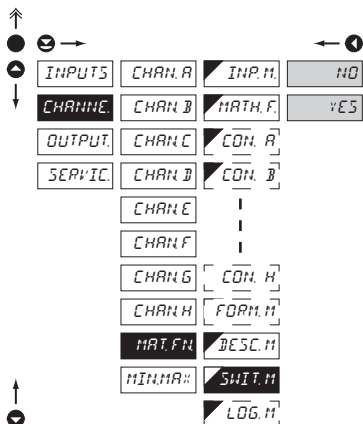
**6.2.2e** Mathematics functions - selection of channel projection upon switching

**SWIT.M** Selection of channel projection upon switching

- setting in this item allows the user to choose individual measuring channels, which will get projected upon switching function channels „SWITCH. A“

YES Projection admitted

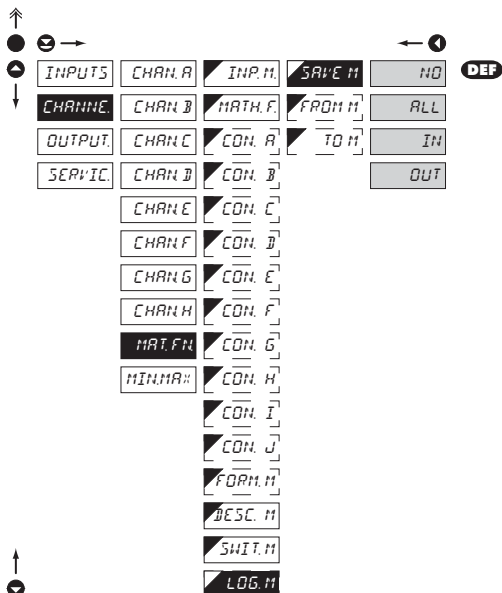
NO Projection denied

**6.2.2f** Mathematics functions - selection of storing data into instrument memory

**LOG.A** Selection of storing data into instrument memory

- by selection in this item you allow to register values into instrument memory  
- another setting in item "OUTPUT. > MEMORY" (not in standard equipment)

NO Measured data are not stored

ALL Measured data are stored in memory

IN Only data measured within the set interval are stored in memory

OUT Only data measured outside the set interval are stored in memory

FROM.A Setting the initial value of interval

- range f setting: -999...9999

TO.A Setting the final value of interval

- range of setting: -999...9999

#### 6.2.3 Selection of evaluation of min/max value

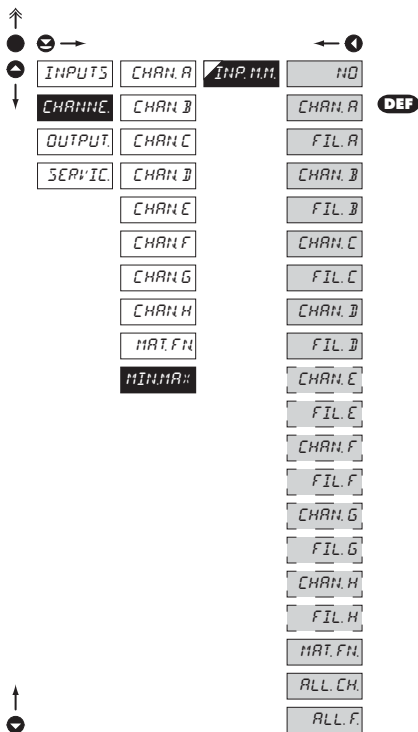

#### **INP.M.M.** Selection of evaluation of min/max value

- selection of value from which the min/max value will be calculated

**NO** Evaluation of min/max value is off

**CHAN. -** From selected input

- selection from inputs 1, 2, 3, 4, 5, 6, 7, 8

**FIL. -** From selected input after digital filter modification

- selection from inputs 1, 2, 3, 4, 5, 6, 7, 8

**MAT.FN.** From "Mathematic functions"

**ALL.CH.** From all channels

**ALL.F.** From all inputs after digital filter modification

### 6.3 Setting „PROFI“ - OUTPUTS

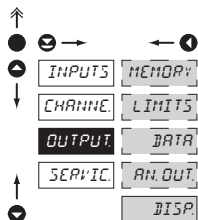

In this menu it is possible to set parameters of the instrument output signals

- MEMORY** Setting data logging into memory
- LIMITS** Setting type and parameters of limits
- DATA** Setting type and parameters of data output
- AN. OUT.** Setting type and parameters of analog output
- DISP** Setting display projection and brightness

#### 6.3.1a Selection of mode of data logging into instrument memory

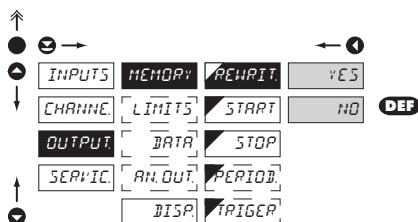

**REWRIT** Selection of the mode of data logging

- selection of the mode in the event of full instrument memory

- NO** Rewriting values prohibited
- YES** Rewriting values permitted, the oldest get rewritten by the latest

#### 6.3.1b Setting data logging into instrument memory - RTC

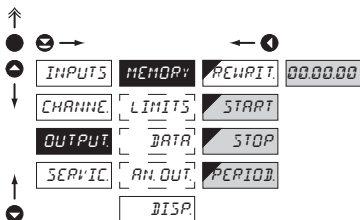

**START** Start of data logging into instrument memory

- time format HH.MM.SS

**STOP** Stop data logging into instrument memory

- time format HH.MM.SS

**PERIOD** Period of data logging into instrument memory

- determines the period in which values will be logged in an interval delimited by the time set under items START and STOP
- time format HH.MM.SS
- records are made on a daily basis in selected interval and period
- item not displayed if "STORE" is selected in menu (Input > EXT. IN.)

#### 6.3.1c Setting data logging into instrument memory - FAST

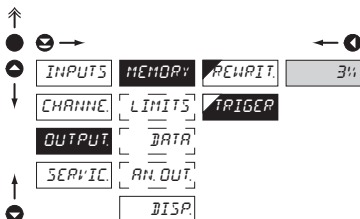

**TRIGGER** Setting logging data into inst. memory

- logging data into inst. memory is governed by the following selection, which determines how many percent of the memory is reserved for data logging prior to initiation of trigger impulse
- initialization is on ext. input or button
- setting in range 1...100 %
- when setting 100 %, datalogging works in the mode ROLL > data keep getting rewritten in cycles

#### 1. Memory initialization

- clear memory (ext.input, button)
- LED "M" flashes, after reading TRIGGER (%) memory is permanently lit. In ROLL flashes constantly.

#### 2. Triggering

- external input, button
- after the memory LED is full "M" turns off
- in the ROLL mode the trigger ends datalogging and LED turns off

#### 3. Termination

- ext.input, button or reading data via RS

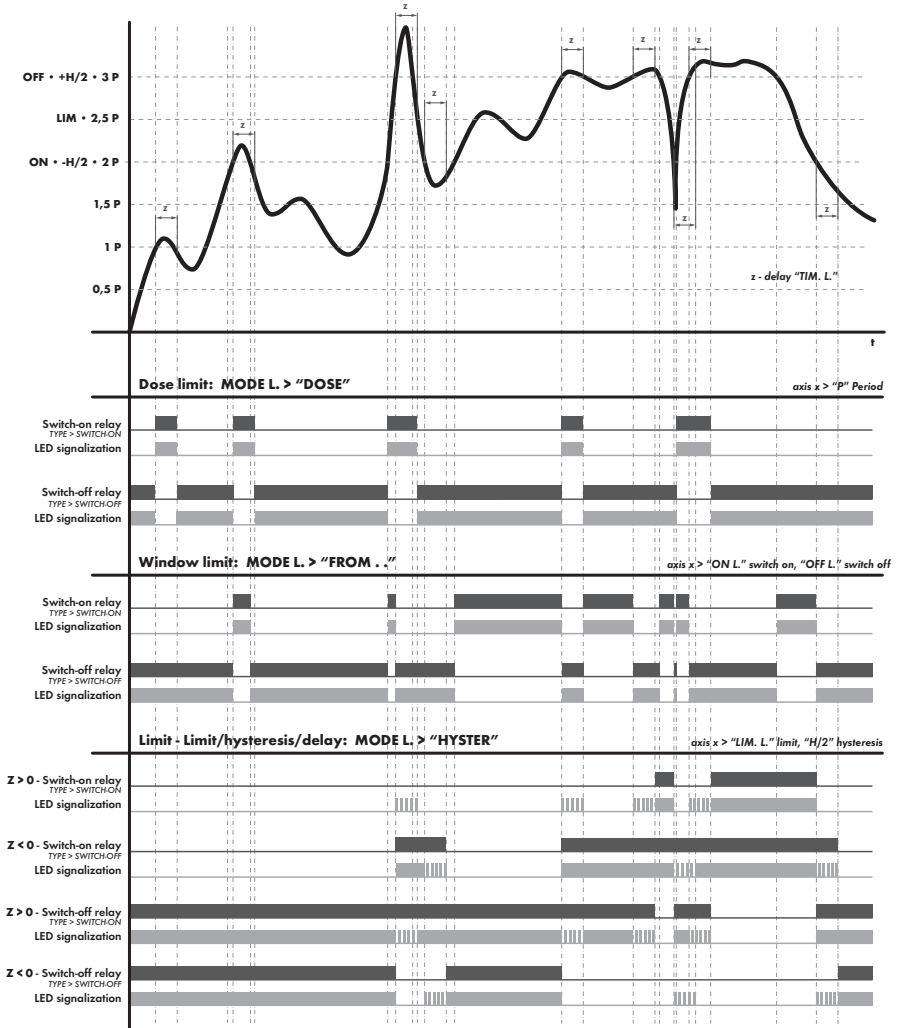



#### 6.3.2a Selection of input for limits evaluation

INPUTS	MEMORY	LIM 1	INP.L1	NO
CHANNEL	LIMITS	LIM 2	CH.L1	CHAN.A
OUTPUT	DATA	LIM 3	MOD.L1	FIL.A
SERVIC.	AN.OUT.	LIM 4	Typ.L1	CHAN.B
	DISP.	LIM 5	LIM.L1	FIL.B
		LIM 6	HVS.L1	CHAN.C
		LIM 7	OH.L1	FIL.C
		LIM 8	OFF.L1	CHAN.D
			PER.L1	FIL.D
			TIM.L1	CHAN.E
				FIL.E
				CHAN.F
				FIL.F
				CHAN.G
				FIL.G
				CHAN.H
				FIL.H
				MAT.FN
				MIN
				MAX
				ALL.CH
				ALL.F

#### INP.L1 Selection evaluation of limits

- selection of value from which the limit will be evaluated

**NO** Limit evaluation is off

**CHAN. -** From selected input

- selection from inputs 1, 2, 3, 4, 5, 6, 7, 8

**FIL. -** From selected input after digital filter modification

- selection from inputs 1, 2, 3, 4, 5, 6, 7, 8

**MAT.FN.** Limit evaluation from "Mathematic functions"

**MIN** Limit evaluation from "Min.value"

**MAX** Limit evaluation from "Max.value"

**ALL.CH.** From all inputs

**ALL.F.** From all inputs after digital filter modification



Setting is identical for LIM 2 ... LIM 8

## 6.3.2b Selection of channels for limit evaluation

↑

⊙ ⊕ →

⬆️ ①

INPUTS	MEMORY	LIM 1	INP.L.1	F.F.	YES-NO
CHANNE	LIMITS	LIM 2	CH.L.1	F.F.	
OUTPUT	DATA	LIM 3	MOD.L.1	F.F.	
SERVIC	AN.OUT	LIM 4	TYP.L.1	F.F.	
	DISP.	LIM 5	LIM.L.1	F.F.	
		LIM 6	HYS.L.1	F.F.	
		LIM 7	ON.L.1	F.F.	
		LIM 8	OFF.L.1	F.H.	
			PER.L.1		
			TIM.L.1		

↑

⊙ ⊕

**CH.L.1** Selection of channels for limit evaluation

- function is available only upon setting "ALL.CH." or "ALL.F." in item menu OUTPUT/LIMITS/LIM 1/INP.L1, when selecting "ALL.CH.", then description "CH.A...H" is displayed here, upon selection of "ALL.F." description "F.A...H"
- setting allows assigning an arbitrary number of measuring channels to one limit for their evaluation
- the limit is active if at least one value from arbitrary channel exceeds the set value
- **DEF** = YES

Setting is identical for LIM 1, LIM 2, LIM 3 i LIM 4

## 6.3.2c Selection of type of limit

↑

⊙ ⊕ →

⬆️ ①

INPUTS	MEMORY	LIM 1	INP.L.1	HYS.TER	DEF
CHANNE	LIMITS	LIM 2	CH.L.1	FROM	
OUTPUT	DATA	LIM 3	MOD.L.1	DOSING	
SERVIC	AN.OUT	LIM 4	TYP.L.1		
	DISP.	LIM 5	LIM.L.1		
		LIM 6	HYS.L.1		
		LIM 7	ON.L.1		
		LIM 8	OFF.L.1		
			PER.L.1		
			TIM.L.1		

↑

⊙ ⊕

**MOD.L.1** Selection the type of limit

- HYS.TER** Limit is in mode "Limit, hysteresis, delay"
- for this mode the parameters of "LIM.L." are set, at which the limit will shall react, "HYS.L." the hysteresis range around the limit (LIM ±1/2 HYS) and time "TIM.L." determining the delay of relay switch-on
- FROM** Frame limit
- for this mode the parameters are set for interval "ON.L." the relay switch-on and "OFF.L." the relay switch-off
- DOSING** Dose limit (periodic)
- for this mode the parameters are set for "PER.L." determining the limit value as well as its multiples at which the output is active and "TIM.L." indicating the time during which is the output active

Setting is identical for LIM 2 ... LIM 8

#### 6.3.2d Selection of type of output

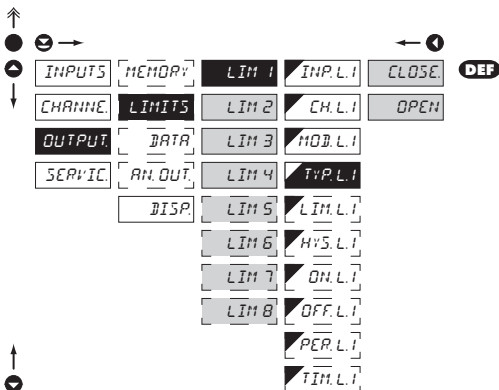

**TYP.L.1** Selection of type of output

**CLOSE** Output switches on when condition is met

**OPEN** Output switches off when condition is met

! Setting is identical for LIM 2 ... LIM 8

#### 6.3.2e Setting values for limits evaluation

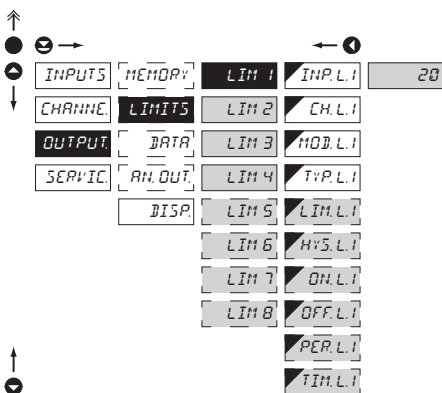

**LIM.L.1** Setting limit for switch-on

- for type "HYSTER"

**HYS.L.1** Setting hysteresis

- for type "HYSTER"  
- indicates the range around the limit (in both directions, LIM.  $\pm 1/2$  HYS.)

**DN.L.1** Setting the outset of the interval of limit switch-on

- for type "FROM"

**OFF.L.1** Setting the end of the interval of limit switch-on

- for type "FROM"

**PER.L.1** Setting the period of limit switch-on

- for type "DOSE"

**TIM.L.1** Setting the time switch-on of the limit

- for type "HYSTER" and "DOSE"  
- setting in range:  $\pm 0...99,9$  s  
- positive time > relay switches after the limit is exceeded (LIM. L.1) and time setting (TIM. L.1)  
- negative time > relay switches off after the limit is exceeded (LIM. L.1) and set negative time (TIM. L.1)



Setting is identical for LIM 2 ... LIM 8

## 6.3.3a Selection of data output baud rate

↑

● →

← ●

INPUTS	MEMORY	<b>BAUD</b>	600
CHANNE	LIMITS	ADDR	1200
<b>OUTPUT</b>	<b>DATA</b>	ADDR.P.B.	2400
SERVIC	AN. OUT	PROT.	4800
	DISP.		9600
			19200
			38400
			57600
			115200
			230400

↓

↑

●

**DEF**

<b>BAUD</b>	Selection of data output baud rate
600	Rate - 600 Baud
1200	Rate - 1 200 Baud
2400	Rate - 2 400 Baud
4800	Rate - 4 800 Baud
9600	Rate - 9 600 Baud
19200	Rate - 19 200 Baud
38400	Rate - 38 400 Baud
57600	Rate - 57 600 Baud
115200	Rate - 115 200 Baud
230400	Rate - 230 400 Baud

## 6.3.3b Setting instrument address

↑

● →

← ●

INPUTS	MEMORY	BAUD
CHANNE	LIMITS	<b>ADDR</b>
<b>OUTPUT</b>	<b>DATA</b>	ADDR.P.B.
SERVIC	AN. OUT	PROT.
	DISP.	

↓

↑

●

<b>ADDR</b>	Setting instrument address
-	setting in range 0...31
-	<b>DEF</b> = 00

<b>ADDR.P.B.</b>	Setting instrument address - PROFIBUS
-	setting in range 1...247
-	<b>DEF</b> = 1

#### 6.3.3c Selection of data output protocol

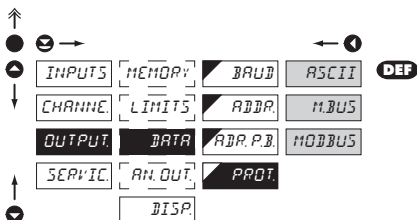

#### **PROT.** Selection of the type of analog output

- ASCII** Data protocol ASCII
  - M.BUS** Data protocol DIN MessBus
  - MODBUS** Data protocol MODBUS-RTU
- option is available only for RS 485

#### 6.3.4a Selection of input for analog output

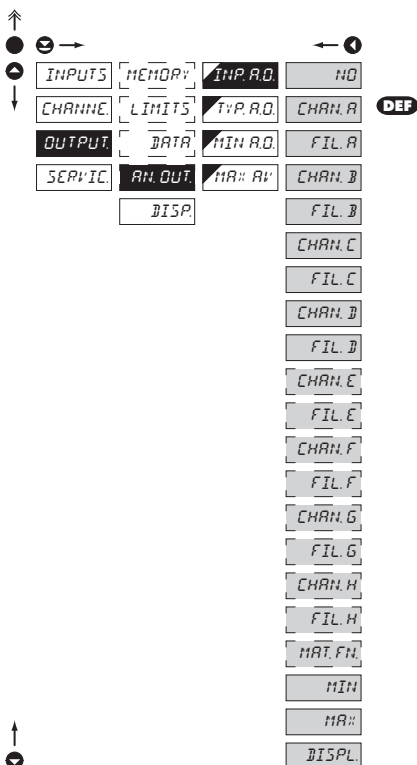

#### **INP.A.O.** Selection evaluation analog output

- selection of value from which the analog output will be evaluated
- NO** AO evaluation is off
- CHAN.-** From selected input
- selection from inputs 1, 2, 3, 4, 5, 6, 7, 8
- FIL.-** From selected input after digital filter modification
- selection from inputs 1, 2, 3, 4, 5, 6, 7, 8
- MAT.FN.** AO evaluation from "Math.functions"
- MIN** AO evaluation from "Min.value"
- MAX** AO evaluation from "Max.value"
- DISPL.** From currently displayed value

### 6.3.4b Selection of the type of analog output

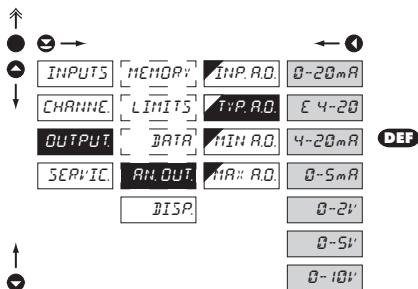

#### TYP. A.O. Selection of the type of analog output

0-20mA Type - 0...20 mA

0-20 Type - 4...20 mA

- with indication of error statement (< 3,0 mA)

4-20mA Type - 4...20 mA

0-5mA Type - 0...5 mA

0-2V Type - 0...2 V

0-5V Type - 0...5 V

0-10V Type - 0...10 V

### 6.3.4c Setting the analog output range

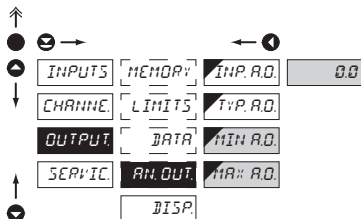

#### AN. OUT. Setting the analog output range

- analog output is isolated and its value corresponds with displayed data. It is fully programmable, i.e. it allows to assign the AO limit points to two arbitrary points of the entire measuring range

MIN. A.O. Assigning the display value to the beginning of the AO range

- range of the setting is -999...9999

- DEF = 0

MA: A.O. Assigning the display value to the end of the AO range

- range of the setting is -999...9999

- DEF = 100

#### 6.3.5a Selection of input for display projection

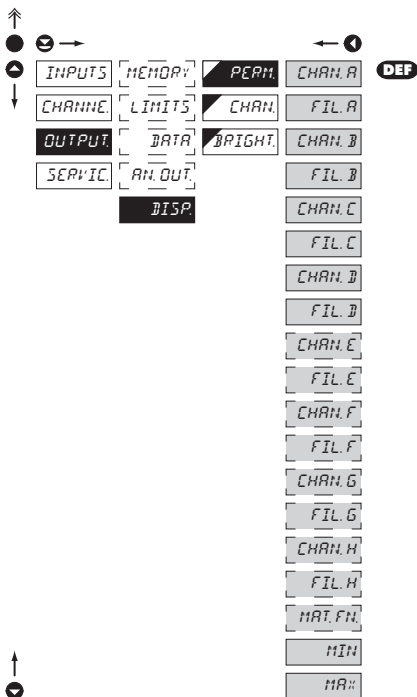

<b>PERM.</b>	<b>Selection display projection</b>
	- selection of value which will be shown on the instrument display
<b>CHAN. A</b>	Projection of values from "Channel A"
<b>FIL. A</b>	From "Channel A" after digital filters processing
<b>CHAN. B</b>	Projection of values from "Channel B"
<b>FIL. B</b>	From "Channel B" after digital filters processing
<b>CHAN. C</b>	Projection of values from "Channel C"
<b>FIL. C</b>	From "Channel C" after digital filters processing
<b>CHAN. D</b>	Projection of values from "Channel D"
<b>FIL. D</b>	From "Channel D" after digital filters processing
<b>CHAN. E</b>	Projection of values from "Channel E"
<b>FIL. E</b>	From "Channel E" after digital filters processing
<b>CHAN. F</b>	Projection of values from "Channel F"
<b>FIL. F</b>	From "Channel F" after digital filters processing
<b>CHAN. G</b>	Projection of values from "Channel G"
<b>FIL. G</b>	From "Channel G" after digital filters processing
<b>CHAN. H</b>	Projection of values from "Channel H"
<b>FIL. H</b>	From "Channel H" after digital filters processing
<b>MAT. FN.</b>	Projection of values from "Math.functions"
<b>MIN.</b>	Projection of values from "Min.value"
<b>MAX.</b>	Projection of values from "Max.value"

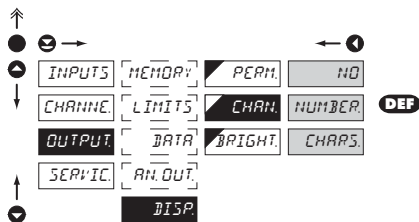
**6.3.5b Selection of signalization of measuring inputs on display**

**CHARN.** Selection of inputs signalization

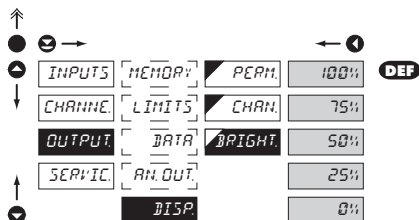
- NO** Display is off
- NUMBER** Numeric description of inputs  
- inputs are marked 1, 2, 3, 4, 5, 6, 7, 8
- CHARS** Alphabetical description of inputs  
- inputs are marked A, B, C, D, E, F, G, H

**6.3.5c Selection of display brightness**

**BRIGHT** Selection of display brightness

- by selecting display brightness we may appropriately react to light conditions in place of instrument location
- 0%** Display is off
- after keystroke display turns on for 10 s
- 25%** Display brightness - 25%
- 50%** Display brightness - 50%
- 75%** Display brightness - 75%
- 100%** Display brightness - 100%





*After restoration the instrument switches off for couple seconds*

## 6.4 Setting "PROFI" - SERVICE

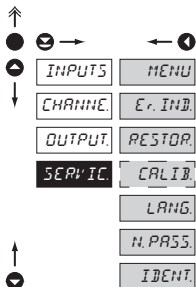

The instrument service functions are set in this menu

<b>MENU</b>	Selection of menu type LIGHT/PROFI
<b>Er. IND.</b>	Selection of type of error statement signalization
<b>RESTOR.</b>	Restore instrument manufacture setting and calibration
<b>CALIB.</b>	Input range calibration for „DU“ version
<b>LANG.</b>	Language version of instrument menu
<b>H. PASS.</b>	Setting new access password
<b>IDENT.</b>	Instrument identification

### 6.4.1 Selection of type of programming menu

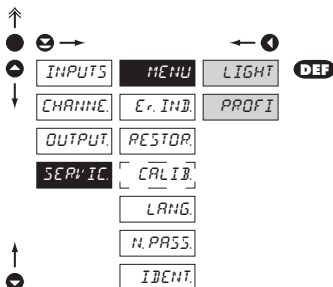

**MENU** Selection of menu type - LIGHT/PROFI

- enables setting the menu complexity according to user needs and skills

**LIGHT** Active LIGHT menu

- simple programming menu, contains only items necessary for configuration and instrument setting  
- linear menu > items one after another

**PROFI** Active PROF I menu

- complete programming menu for expert users  
- tree menu



Change of setting is valid upon next access into menu

#### 6.4.2 Selection of type of error statement signalization

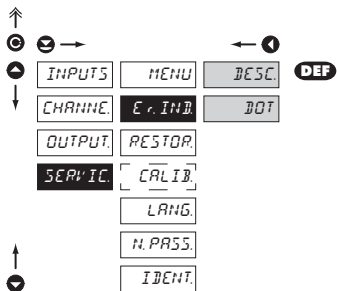

#### Er. IND. Selection of type of error statement signalization

- selection of type of signalization relates only to error statements on active measuring inputs, which are not currently projected on the display
- error on the displayed active input is always indicated

**DESC.** Error statements are displayed as text on the display of measuring units

- signalization "E" + no. of input/channel indicating where a measuring error occurred

**DOT** Error statement is signalled only by flashing of the decimal point by the indicated channel number

#### 6.4.3 Restoration of manufacture setting

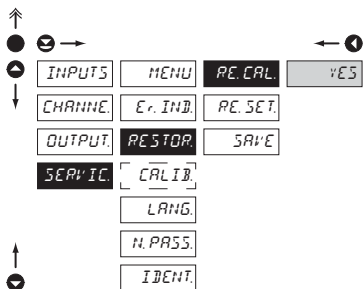

#### RESTOR. Restoration of manufacture setting

- in the event of error setting or calibration, manufacture setting may be restored.

**RE. CAL.** Restoration of manufacture calibration of the instrument

- prior executing the changes you will be asked to confirm your selection „YES“

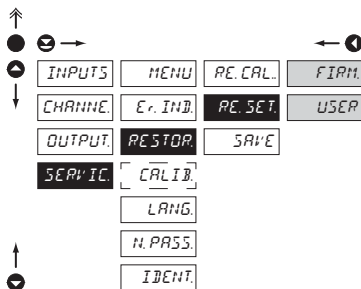

### RE.SET Restoration of instrument manufacture setting

**FIRM** Restoration of instrument manufacture setting

- generating the manufacture setting for currently selected type of instrument (items marked DEF)

**USER** Restoration of instrument user setting

- generating the instrument user setting, i.e. setting stored under SERVIC./RESTOR./SAVE

**SAVE** Save instrument user setting

- storing the user setting allows the operator to restore it in future if needed

#### 6.4.4 Calibration - Input range

DU

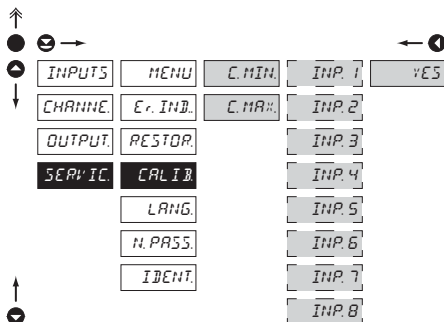

### CALIB Input range calibration

- the inputs for calibration always include only active inputs, i.e. those that are ser for "MOD > DU".
- after projection of "C. MIN." and selection of relevant input move the potentiometer runner into required minimum position and confirm by „Enter“, calibration is confirmed by „YES“ notice
- after projection of "C. MAX." and selection of given input move the potentiometer into required maximum position and confirm by „Enter“, calibration is confirmed by „YES“

#### 6.4.5 Selection of instrument menu language version

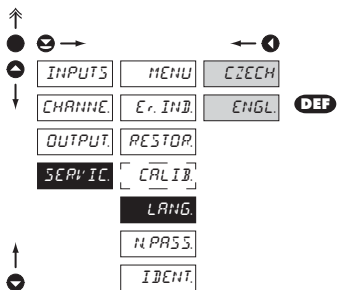

LANG.	Selection of instrument menu language version
CZECH	Instrument menu is in Czech
ENGL.	Instrument menu is in English

#### 6.4.6 Setting new access password

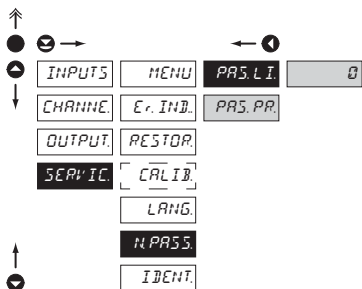

N.PASS.	Setting new password for access to LIGHT and PROFIL menu
<ul style="list-style-type: none"> <li>- this selection enables changing number code that blocks the access into LIGHT and PROFIL Menu.</li> <li>- range of the number code is 0...9999</li> <li>- universal password in the event of loss: LIGHT Menu &gt; „8177“ PROFIL Menu &gt; „7915“</li> </ul>	

## 6.4.7 Instrument identification

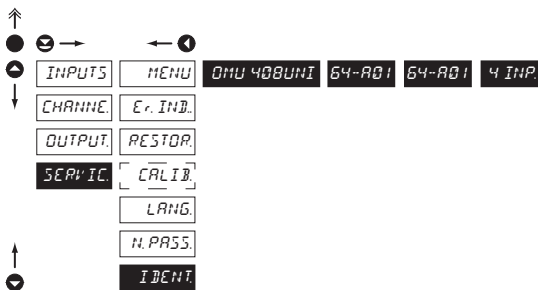

**IDENT.** Projection of instrument SW version

- display shows type identification of the instrument, SW number, SW version and current input setting (Mode)
- if the SW version reads a letter on first position, it is a customer SW
- after the identification is completed the menu is automatically exited and the instrument restores the measuring mode

	Packet	Description
<b>IDENT.</b>	1.	type of instrument
	2.	no-of program version - processor 1
	3.	no. of program version - processor 2
	4.	no. of active measuring inputs



## 7.0 Setting items into "USER" menu

- **USER** menu is designed for users who need to change only several items of the setting without the option to change the primary instrument setting (e.g. repeated change of limit setting)
- there are no items from manufacture permitted in **USER** menu
- on items indicated by inverse triangle  L i
- setting may be performed in **LIGHT** or **PROFI** menu, with the **USER** menu then overtaking the given menu structure



- For user operation
- Menu items are set by the user (Profi/Light) as per request
- Access is not password protected

## Setting

*flashing legend - current setting is displayed*



NO

item will not be displayed in USER menu

YES

item will be displayed in USER menu with editing option

SHOW

item will be solely displayed in USER menu



### Setting sequence of items in "USER" menu

In compiling USER menu from active LIGHT menu the items (max. 10) may be assigned a sequence, in which they will be projected in the menu

*setting projection sequence*



#### Example:

Into USER menu were selected these items

(keys  $\leftarrow$  +  $\rightarrow$ ) > TARE A, LIM 1, LIM 2, LIM 3, for which we have preset this sequence (keys  $\leftarrow$  +  $\rightarrow$ ):

TARE A	5
LIM 1	0 (sequence not determined)
LIM 2	2
LIM 3	1

Upon entering USER menu

(key  $\rightarrow$ ) items will be projected in the following sequence: LIM 3 > LIM 2 > TARE A > LIM 1

Instrument with input for temperature measurement with thermocouple allows to set two types of measurement of cold junction.

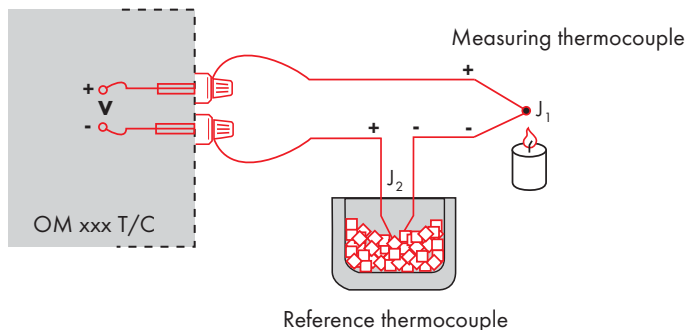

#### WITH REFERENCE THERMOCOUPLE

- a reference thermocouple may be located in the same place as the measuring instrument or in place with stable temperature/compensation box
- when measuring with reference thermocouple set **CONNECT** in the instrument menu to **INT2TC** or **E::T2TC**
- when using a thermostat (a compensation box or environment with constant temperature) set in the instrument menu **CJCTEM** its temperature (applies for setting **CONNECT** to **E::T2TC**)
- if the reference thermocouple is located in the same environment as the measuring instrument then set in the instrument menu **CONNECT** to **INT2TC**. Based on this selection the measurement of the ambient temperature is performed by a sensor located in the instrument terminal board.

#### WITHOUT REFERENCE THERMOCOUPLE

- inaccuracy originating from the creation of dissimilar thermocouples on the transition point terminal/conductor of the thermocouple is not compensated for in the instrument
- when measuring without reference thermocouple set **CONNECT** in the instrument menu to **INT1TC** or **E::T1TC**
- when measuring temperature without reference thermocouple the error in measured data may be as much as 10°C (applies for setting **CONNECT** to **E::T1TC**)



*If at least 1 thermocouple uses internal compensation of cold junction, it has to be measured on 1st channel. Only on this channel it is possible to measure the temperature of cold junction, which is used for all channels with thermocouples.*



The instruments communicate via serial line RS232 or RS485. For communication they use the ASCII protocol. Communication runs in the following format:

ASCII: 8 bit, no parity, one stop bit  
 DIN MessBus: 7 bit, even parity, one stop bit

The transfer rate is adjustable in the instrument menu. The instrument address is set in the instrument menu in the range of 0 ÷ 31. The manufacture setting always presets the ASCII protocol, rate of 9600 Baud, address 00. The type of line used - RS232 / RS485 - is determined by an output board automatically identified by the instrument.

The commands are described in specifications you can find at [na www.orbit.merret.cz/rs](http://na.www.orbit.merret.cz/rs) or in the OM Link program.

### DETAILED DESCRIPTION OF COMMUNICATION VIA SERIAL LINE

Event	Type	Protocol	Transmitted data																	
Data solicitation (PC)	232	ASCII	#	A	A	<CR>														
		MessBus	No - data is transmitted permanently																	
	485	ASCII	#	A	A	<CR>														
		MessBus	<SADR>	<ENQ>																
Data transmission (instrument)	232	ASCII	>	D	(D)	(D)	(D)	(D)	(D)	(D)	(D)	(D)	(D)	(D)	(D)	(D)	(D)	<CR>		
		MessBus	<SADR>	D	(D)	(D)	(D)	(D)	(D)	(D)	(D)	(D)	(D)	(D)	(D)	(D)	(D)	(D)	<ETX>	<BCC>
	485	ASCII	>	D	(D)	(D)	(D)	(D)	(D)	(D)	(D)	(D)	(D)	(D)	(D)	(D)	(D)	(D)	<CR>	
		MessBus	<SADR>	D	(D)	(D)	(D)	(D)	(D)	(D)	(D)	(D)	(D)	(D)	(D)	(D)	(D)	(D)	<ETX>	<BCC>
Confirmation of data acceptance (PC) - OK	485	MessBus	<DLE>	1																
Confirmation of data acceptance (PC) - Bad			<NAK>																	
Sending address (PC) prior command			<EADR>	<ENQ>																
Confirmation of address (instrument)			<SADR>	<ENQ>																
Command transmission (PC)	232	ASCII	#	A	A	N	P	(D)	(D)	(D)	(D)	(D)	(D)	(D)	(D)	(D)	(D)	<CR>		
		MessBus	<STX>	\$	N	P	(D)	(D)	(D)	(D)	(D)	(D)	(D)	(D)	(D)	(D)	(D)	<ETX>	<BCC>	
	485	ASCII	#	A	A	N	P	(D)	(D)	(D)	(D)	(D)	(D)	(D)	(D)	(D)	(D)	<CR>		
		MessBus	<SADR>	\$	N	P	(D)	(D)	(D)	(D)	(D)	(D)	(D)	(D)	(D)	(D)	(D)	<ETX>	<BCC>	
Command confirmation (instrument)	232	ASCII	OK	!	A	A	<CR>													
			Bad	?	A	A	<CR>													
		MessBus	No - data is transmitted permanently																	
			OK	!	A	A	<CR>													
	485	ASCII	Bad	?	A	A	<CR>													
			OK	<DLE>	1															
		MessBus	OK	<DLE>	1															
			Bad	<NAK>																
Command confirmation (inst.) - OK	485	MessBus	!	A	A	<CR>														
?			A	A	<CR>															
Instrument identification			#	A	A	1Y	<CR>													
HW identification			#	A	A	1Z	<CR>													
One-time transmission			#	A	A	7X	<CR>													
Repeated transmission			#	A	A	8X	<CR>													

## LEGEND

#	35	23 <sub>H</sub>	Command beginning
A	A	0...31	Two characters of instrument address (sent in ASCII - tens and units, e.g. "01", "99" universal)
<CR>	13	0D <sub>H</sub>	Carriage return
<SP>	32	20 <sub>H</sub>	Space
N, P			Number and command - command code
D			Data - usually characters "0"... "9", ".", "-", ";", (D) - dp. and (-) may prolong data
R	30 <sub>H</sub> ...3F <sub>H</sub>		Relay and tare status
!	33	21 <sub>H</sub>	Positive confirmation of command (ok)
?	63	3F <sub>H</sub>	Negative confirmation of command (point)
>	62	3E <sub>H</sub>	Beginning of transmitted data
<STX>	2	02 <sub>H</sub>	Beginning of text
<ETX>	3	03 <sub>H</sub>	End of text
<SADR>	address +60 <sub>H</sub>		Prompt to send from address
<EADR>	address +40 <sub>H</sub>		Prompt to accept command at address
<ENQ>	5	05 <sub>H</sub>	Terminate address
<DLE>1	16 49	10 <sub>H</sub> 31 <sub>H</sub>	Confirm correct statement
<NAK>	21	15 <sub>H</sub>	Confirm error statement
<BCC>			Check sum -XOR

## RELAY, TARE

Sign	Relay 1	Relay 2	Tare	Change relay 3/4
P	0	0	0	0
Q	1	0	0	0
R	0	1	0	0
S	1	1	0	0
T	0	0	1	0
U	1	0	1	0
V	0	1	1	0
W	1	1	1	0
p	0	0	0	1
q	1	0	0	1
r	0	1	0	1
s	1	1	0	1
t	0	0	1	1
u	1	0	1	1
v	0	1	1	1
w	1	1	1	1

Relay status is generated by command #AA6X <CR>.

The instrument immediately returns the value in the format >HH <CR>, where HH is value in HEX format and range 00<sub>H</sub>...FF<sub>H</sub>. The lowest bit stands for „Relay 1“, the highest for „Relay 8“

ERROR	CAUSE	ELIMINATION
<i>E. D. U<sub>n</sub></i>	Number is too small (large negative) to be displayed	change DP setting, channel constant setting
<i>E. D. O<sub>r</sub></i>	Number is too large to be displayed	change DP setting, channel constant setting
<i>E. T. U<sub>n</sub></i>	Number is outside the table range	increase table values, change input setting (channel constant setting)
<i>E. T. O<sub>r</sub></i>	Number is outside the table range	increase table values, change input setting (channel constant setting)
<i>E. I. U<sub>n</sub></i>	Input quantity is smaller than permitted input quantity range	change input signal value or input (range) setting
<i>E. I. O<sub>r</sub></i>	Input quantity is larger than permitted input quantity range	change input signal value or input (range) setting
<i>E. H<sub>U</sub></i>	A part of the instrument does not work properly	send the instrument for repair
<i>E. E<sub>E</sub></i>	Data in EEPROM corrupted	perform restoration of manufacture setting, upon repeated error statement send instrument for repair
<i>E. S<sub>E</sub>T.</i>	Data in EEPROM outside the range	change setting if dependent items, perform restoration of manufacture setting, upon repeated error statement send instrument for repair
<i>E. C<sub>L</sub>R.</i>	Memory was empty (presetting carried out)	upon repeated error statement send instrument for repair, possible failure in calibration

Type of error signalization on channels, which are not currently displayed is selectable in menu *SERVIC./Er. IND.*

The instrument allows to add two descriptive characters to the classic numeric formats (at the expense of the number of displayed places). The setting is performed by means of a shifted ASCII code. Upon modification the first two places display the entered characters and the last two places the code of the relevant symbol from 0 to 95. Numeric value of given character equals the sum of the numbers on both axes of the table.

Description is cancelled by entering characters with code 00

0		Q	"	£	\$	¥	€	'	0		!	"	#	\$	%	&	'
8	(	)	*	+	,	-	.	/	8	(	)	*	+	,	-	.	/
16	0	1	2	3	4	5	6	7	16	0	1	2	3	4	5	6	7
24	8	9	VA	Vr	<	=	>	?	24	8	9	VA	Vr	<	=	>	?
32	Q	R	B	C	D	E	F	G	32	@	A	B	C	D	E	F	G
40	H	I	J	K	L	M	N	O	40	H	I	J	K	L	M	N	O
48	P	Q	R	S	T	U	V	W	48	P	Q	R	S	T	U	V	W
56	X	Y	Z	[	\	]	^	_	56	X	Y	Z	[	\	]	^	_
64	`	a	b	c	d	e	f	g	64	`	a	b	c	d	e	f	g
72	h	i	j	k	l	m	n	o	72	h	i	j	k	l	m	n	o
80	p	q	r	s	t	u	v	w	80	p	q	r	s	t	u	v	w
88	X	Y	Z	{		}	~		88	x	y	z	{		}	~	

**INPUT**

Number: 4/8 inputs  
- automatic or manual switching

range is adjustable

±60 mV	>100 MOhm
±150 mV	>100 MOhm
±300 mV	>100 MOhm
±1200 mV	>100 MOhm

**DC**

Input U  
Input U  
Input U  
Input U

range is adjustable

0/4...20 mA	< 400 mV
±2 V	1 MOhm
±5 V	1 MOhm
±10 V	1 MOhm
±40 V	1 MOhm

**PM**

Input I  
Input U  
Input U  
Input U  
Input U

range is adjustable

0...100 Ohm
0...1 kOhm
0...10 kOhm
0...100 kOhm

**OHM**

Connection:

2, 3 or 4 wire

**RTD**

Pt xxxx

-200°...850°C

Pt xxxx/3910 ppm

-200°...1 100°C

Ni xxxx

-50°...250°C

Cu/4260 ppm

-50°...200°C

Cu/4280 ppm

-200°...200°C

Type Pt:

EU &gt; 100/500/1 000 Ohm, with 3 850 ppm/°C

US &gt; 100 Ohm, with 3 920 ppm/°C

RU &gt; 50/100 Ohm, with 3 910 ppm/°C

Type Ni:

Ni 1 000/ Ni 10 000 with 5 000/6 180 ppm/°C

Type Cu:

Cu 50/Cu 100 with 4 260/4 280 ppm/°C

Connection:

2, 3 or 4 wire

range is adjustable in configuration menu

Type:

J (Fe-CuNi)	-200°...900°C
K (NiCr-Ni)	-200°...1 300°C
T (Cu-CuNi)	-200°...400°C
E (NiCr-CuNi)	-200°...690°C
B (PtRh30-PtRh6)	300°...1 820°C
S (PtRh10-Pt)	-50°...1 760°C
R (Pt13Rh-Pt)	-50°...1 740°C
N (Omegalloy)	-200°...1 300°C
L (Fe-CuNi)	-200°...900°C

**T/C**

Voltage of lin. pot.

2,5 VDC/6 mA

min. potentiometer resistance is 500 Ohm

**DU****PROJECTION**

Measured value

9999, intensive red or green  
14-segment LED, digit height 14 mm

Description

99, intensive red or green  
14-segment LED, digit height 10 mm  
9, intensive red or green  
7-segment LED, digit height 9 mm

Input number

-999...9999

Projection:

adjustable - in menu

Brightness:

adjustable - in menu

**INSTRUMENT ACCURACY**

TC:

100 ppm/°C

Accuracy:

±0,1 % of range + 1 digit

±0,15 % of range + 1 digit

**RTD, T/C**

Resolution:

0,01°/0,1°/1°

**RTD**

Rate:

0,1...40 measurements/s\*\*

Overload capacity:

10x (t &lt; 100 ms), 2x (long-term)

Linearisation:

by linear interpolation in 254 points (solely via OM Link)

Digital filters:

Averaging, Floating average, Exponential filter, Rounding

Inputs switching:

0,5 ... 99,9 s

Comp. of conduct:

max. 40 Ohm/100 Ohm

**RTD**

Comp. of cold junct.:

adjustable

**T/C**

Functions:

0°...99°C or automatic

Tare - display resetting

Hold - stop measuring (at contact)

Lock - control key locking

MM - min/max value

Mathematic functions

OM Link:

company communication interface for setting, operation and update of instrument SW

Watch-dog:

reset after 400 ms

Calibration:

at 25°C and 40 % of r.h.

**COMPARATOR**

Type:

digital, adjustable in menu

Mode:

Hysteresis, From, Dosing

Limita:

-999...9999

Hysteresis:

0...9999

Delay:

0...99,9 s

Outputs:

4x/8x relays with switch-on contact (Form A)

(230 VAC/30 VDC, 3 A)\*

Relay:

1/8 HP 277 VAC, 1/10 HP 125 V, Pilot Duty D300

**DATA OUTPUTS**

Protocols:

ASCII, DIN MessBus, MODBUS, PROBUS

Data format:

8 bit + no parity + 1 stop bit (ASCII)

7 bit + even parity + 1 stop bit (MessBus)

Rate:

600...230 400 Baud

9 600 Baud...12 Mbaud (PROFIBUS)

RS 232:

isolated, two-way communication

RS 485:

isolated, two-way communication,

addressing (max. 31 instruments)

PROFIBUS

Data protocol SIEMENS

\* values apply for resistance load



**ANALOG OUTPUTS**

Type: isolated, programmable with resolution of max.10 000 points, analog output corresponds with displayed data, type and range are adjustable

Non-linearity: 0.2 % of range

TC: 100 ppm/°C

Rate: response to change of value < 150 ms

Voltage: 0...2 V/5 V/10 V

Current: 0...5/20 mA/4...20 mA  
- compensation of conduct to 500 Ohm/12 V  
or 1 000 Ohm/24 V

**MEASURED DATA RECORD**

Type RTC: time-controlled logging of measured data into instrument memory, allows to log up to 250 000 values

Type FAST: fast data logging into instrument memory, allows to log up to 8 000 values at a rate of 40 records/s

No. of channels	Number of recorded data	Length of the records at 40 m/s [s]
1	16384	409,6
2	8192	204,8
3	5461	136,5
4	4096	102,4
5	3276	81,9
6	2730	68,25
7	2340	58,5
8	2048	50,1
9	1820	45,5

Transmission: via data output RS 232/485 or via OM Link

**POWER SUPPLY**

Options: 10...30 V AC/DC, max 13,5 VA, isolated,  
- fuse inside (T 4000 mA)  
80...250 V AC/DC, max. 13,5 VA, isolated  
- fuse inside (T 6300 mA)

**MECHANIC PROPERTIES**

Material: Noryl GFN2 SE1, incombustible UL 94 V-I

Dimensions: 96 x 48 x 120 mm

Panel cut-out: 90,5 x 45 mm

**OPERATING CONDITIONS**

Connection: connector terminal board, conductor cross-section <1,5 mm<sup>2</sup> / <2,5 mm<sup>2</sup>

Stabilisation period: within 15 minutes after switch-on

Working temp.: 0°...60°C

Storage temp.: -10°...85°C

Cover: IP65 (front panel only)

Construction: safety class I

Dielectric strength: 4 kVAC after 1 min between supply and input  
4 kVAC after 1 min between supply and data/analog output  
4 kVAC after 1 min between supply and relay output  
2,5 kVAC after 1 min between supply and data/analog output

Overvoltage cat.: EN 61010-1, A2

Insulation resistance: for pollution degree II, measurement category III  
instrum.power supply > 670 V (PI), 300 V (DI)  
Input/output > 300 V (PI), 150 (DI)

EMC: EN 61000-3-2+A12; EN 61000-4-2, 3, 4, 5, 8, 11;  
EN 550222, A1, A2

Seismic resistance: IEC 980: 1993, cl. 6

*\*\*Table of measuring rate on one channel, according to setting of input mode and type of measurement*

Channels/Rate	40	20	10	5	2	1	0,5	0,2	0,1
Input mode > SWITCH - single channel measurement	40,00	20,00	10,00	5,00	2,00	1,00	0,50	0,20	0,10
Input mode > SWITCH - dual channel measurement	6,667	3,333	1,667	1,25	0,714	0,417	0,227	0,096	0,049
Input mode > CYCLE - 2x single channel meas.	6,667	3,333	1,667	1,25	0,714	0,417	0,227	0,096	0,049
Input mode > CYCLE - 1x single + 1x dual channel measurement	4,444	2,222	1,111	0,833	0,476	0,278	0,152	0,064	0,033
Input mode > CYCLE - 2x dual channel measurement	3,333	1,667	0,833	0,625	0,357	0,208	0,114	0,048	0,025

Measuring rate in the menu is indicated for mode SWITCH and single channel measurement.  
Single channel measurement > DC, PM, DU, OHM - 2/4 wire, Pt - 2/4 wire, Ni - 2/4 wire, Cu - 2/4 wire, TC on 1st input with external compensation, TC on other inputs  
Dual channel measurement > OHM - 3 wire, Pt - 3 wire, Ni - 3 wire, Cu - 3 wire, TC on 1st input with internal compensation  
If at least one TC measurement with internal compensation is to be used, IT HAS TO BE connected on 1st input. Cold junction value is measured here!  
The instrument contains up to 4 A/D converters that always control one pair of inputs 1. + 2., 3. + 4., 5 + 6., 7. + 8. Converters measure almost simultaneously.

Front view

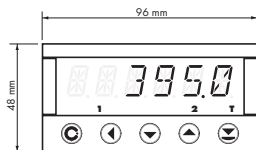

Panel cut

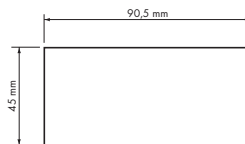

Side view

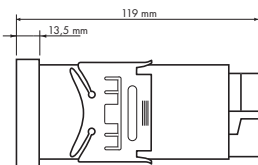

Panel thickness: 0,5...20 mm

### Instrument installation

1. insert the instrument into the panel cut-out
2. fit both travellers on the box
3. press the travellers close to the panel

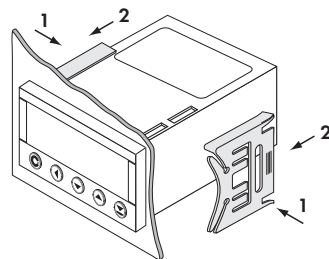
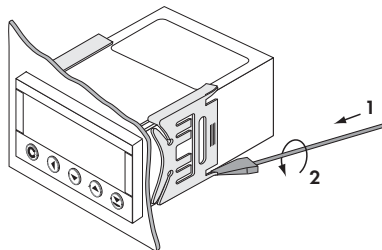

### Instrument disassembly

1. slide a screw driver under the traveller wing
2. turn the screw driver and remove the traveller
3. take the instrument out of the panel

Product **OMU 408UNI**  
 Type .....  
 Manufacturing No. ....  
 Date of sale .....

# GUARANTEE

A guarantee period of 60 months from the date of sale to the user applies to this instrument.  
 Defects occurring during this period due to manufacture error or due to material faults shall be eliminated free of charge.

For quality, function and construction of the instrument the guarantee shall apply provided that the instrument was connected and used in compliance with the instructions for use.

The guarantee shall not apply to defects caused by:

- mechanic damage
- transportation
- intervention of unqualified person incl. the user
- unavoidable event
- other unprofessional interventions

The manufacturer performs guarantee and post.guarantee repairs unless provided for otherwise.

Y E A R S

Stamp, signature

# DECLARATION OF CONFORMITY

**Company:** **ORBIT MERRET, spol. s r.o.**  
Klánska 81/141, 142 00 Prague 4, Czech Republic, IDNo: 00551309

**Manufactured:** **ORBIT MERRET, spol. s r.o.**  
Vodňanská 675/30, 198 00 Prague 9, Czech Republic

declares at its explicit responsibility that the product presented hereunder meets all technical requirements, is safe for use when utilised under the terms and conditions determined by ORBIT MERRET, spol.s r.o. and that our company has taken all measures to ensure conformity of all products of the types referred-to hereunder, which are being brought out to the market, with technical documentation and requirements of the appurtenant Czech statutory orders.

**Product:** 4-digit programmable panel instrument

**Type:** **OMU 408UNI**

It has been designed and manufactured in line with requirements of:

Statutory order no. 17/2003 Coll., on low-voltage electrical equipment (directive no. 73/23/EHS)

Statutory order no. 18/2003 Coll., on electromagnetic compatibility (directive no. 89/336/EHS)

The product qualities are in conformity with harmonized standard:

Electrical safety:	EN 61010-1	
EMC:	EN 50131-1, chapter 14 and chapter 15	
	EN 50130-4, chapter 7	
	EN 50130-4, chapter 8	EN 61000-4-11, ed. 12
	EN 50130-4, chapter 9	EN 61000-4-2
	EN 50130-4, chapter 10	EN 61000-4-3, ed. 12
	EN 50130-4, chapter 11	EN 61000-4-6
	EN 50130-4, chapter 12	EN 61000-4-4, ed. 12
	EN 50130-4, chapter 13	EN 61000-4-5
	EN 61000-4-8	
	EN 61000-4-9	
	EN 61000-6-1	
	EN 61000-6-2	
	EN 55022, chapter 5 and chapter 6	

The product is furnished with CE label issued in 2007.

As documentation serve the protocols of authorized and accredited organizations:

MO ČR, Agency for development of informatics, testing lab no.1558, accredited ČIA, in compliance with EN ISO/EIC 17025

Place and date of issue: Prague, 13. November 2007

Miroslav Hackl v.r.  
Company representative

*Assessment of conformity pursuant to §22 of Act no. 22/1997 Coll. and changes as amended by Act no.71/2000 Coll. and 205/2002 Coll.*