



OMU 408

4/8 CHANNEL DATA LOGGER

DC VOLTMETER/AMMETER
PROCESS MONITOR
OHMMETER
THERMOMETER FOR PT 100/500/1 000
THERMOMETER FOR NI 1 000
THERMOMETER FOR THERMOCOUPLES
DISPLAY UNIT FOR LIN. POTENTIOMETERS



SAFETY INSTRUCTIONS

Please, read the enclosed safety instructions carefully and observe them!
These instruments should be safeguarded by isolated or common fuses (breakers)!
For safety information the EN 61 010-1 + A2 standard must be observed.
This instrument is not explosion-safe!

TECHNICAL DATA

Measuring instruments of the OMU 408 series conform to the European regulation 89/336/EWG and the Ordinance 168/1997 Coll.

The instruments are up to the following European standards:
EN 55 022, class B
EN 61000-4-2, -4, -5, -6, -8, -9, -10, -11

The instruments are applicable for unlimited use in agricultural and industrial areas.

CONNECTION

Supply of energy from the main line has to be isolated from the measuring leads.



ORBIT MERRET, spol. s r.o.

Vodnanská 675/30
198 00 Prague 9
Czech Republic

Tel: +420 - 281 040 200
Fax: +420 - 281 040 299
e-mail: orbit@merret.cz
www.orbit.merret.cz



1.	Contents	3
2.	Instrument description	4
3.	Instrument connection	6
4.	Instrument setting	8
	Symbols used in the instructions	10
	Setting the DP and the (-) sign	10
	Control keys function	11
	Setting/permitting items into "USER" menu	11
5.	Setting "LIGHT" menu	12
5.0	Description "LIGHT" menu	12
	Setting input - Type "DC"	16
	Setting input - Type "PM"	18
	Setting input - Type "DU"	20
	Setting input - Type "OHM"	22
	Setting input - Type "RTD - Pt"	24
	Setting input - Type "RTD - Cu"	26
	Setting input - Type "RTD - Ni"	28
	Setting input - Type "T/C"	30
	Setting Limits	32
	Setting analog output	34
	Selection of programming menu „LIGHT"/„PROFI"	36
	Restoration of manufacture setting	36
	Calibration - input range (DU)	37
	Selection of instrument menu language version	38
	Setting new access password	38
	Instrument identification	39
6.	Setting "PROFI" menu	40
6.0	Description of "PROFI" menu	40
6.1	"PROFI" menu - INPUT	
6.1.1	Resetting internal values	42
6.1.2	Setting measuring type, range, mode, rate,	43
6.1.3	Setting the Real Time	51
6.1.4	External input function selection	52
6.1.5	Optional accessory functions of the keys	53
6.2	"PROFI" menu - CHANNEL	
6.2.1	Setting measuring parameters (projection, filters, decimal point, description)	58
6.2.2	Setting mathematic functions	63
6.2.3	Selection of evaluation of min/max. value	67
6.3	"PROFI" menu - OUTPUT	
6.3.1	Setting data logging	68
6.3.2	Setting Limits	70
6.3.3	Setting data output	73
6.3.4	Setting analog output	74
6.3.5	Selection of display projection	76
6.4	"PROFI" menu - SERVICE	
6.4.1	Selection of programming menu „LIGHT"/„PROFI"	78
6.4.2	Restoration manufacture setting	79
6.4.3	Calibration - input range (DU)	80
6.4.4	Selection of instrument menu language version	80
6.4.5	Setting new access password	81
6.4.6	Instrument identification	81
7.	Setting items into "USER" menu	82
8.	Method of measuring of the cold junction	84
9.	Data protocol	86
10.	Error statements	88
11.	Table of symbols	89
12.	Technical data	90
13.	Instrument dimensions and installation	92
14.	Certificate of guarantee	93

2.1 Description

The OMU 408 is a 4/8 channel data logger, designed for maximum purposefulness and user comfort while maintaining its low cost. It is a multifunction instrument with the option of configuration for 8 different types of input, easily configurable in the menu.

The instrument is based on an 8-bit microprocessor with multi-channel 24-bit sigma-delta converter, which ensures the instrument high accuracy, stability and easy operation.

Major advantage of the instrument is with respect to the high rate of sampling on individual channels the feasibility to evaluate all measuring inputs simultaneously.

The OMU 408UNI is a multifunction instrument available in following types and ranges

DC:	0...60/150/300/1200 mV
PM:	0...5 mA/0...20 mA/4...20 mA/±2 V/±5 V/±10 V/±40 V
OHM:	0...100 Ω/0...1 kΩ/0...10 kΩ/0...100 kΩ
RTD-Pt:	Pt 50/100/Pt 500/Pt 1 000
RTD-Cu:	Cu 50/Cu 100
RTD-Ni:	Ni 1 000/Ni 10 000
T/C:	J/K/T/E/B/S/R/N
DU:	Linear potentiometer (min. 500 Ω)

PROGRAMMABLE PROJECTION

Selection:	of type of input and measuring range
Measuring range:	adjustable as fixed
Setting:	manual, optional projection on the display may be set in the menu for both limit values of the input signal, e.g. input 0...20 mA > 0...850,0
Projection:	-999...9999

COMPENSATION

of conduct:	in the menu it is possible to perform compensation for 2-wire connection
of conduct in probe:	internal connection (conduct resistance in measuring head)
of CJC (T/C):	manual or automatic, in the menu it is possible to perform selection of the type of thermocouple and compensation of cold junctions, which is adjustable or automatic (temperature at the brackets)

LINEARIZATION

Linearization:*	by linear interpolation in 254 points (solely via OM Link)
-----------------	--

DIGITAL FILTERS

Floating average:	from 2...30 measurements
Exponen.average:	from 2...100 measurements
Rounding:	setting the projection step for display

MATHEMATIC FUCTIONS

Min./max. value:	registration of min./max. value reached during measurement
Tare:	designed to reset display upon non-zero input signal
Peak value:	the display shows only max. or min. value
Mat. operations:	polynome, 1/x, logarithm, exponential, power, root, sin x and mathematic operatin between input - total, divergence, divide

EXTERNAL CONTROL

Lock:	control keys blocking
Hold:	display/instrument blocking
Tare:	tare activation/resetting tare to zero
Resetting MM:	resetting min/max value
Memory:	data storage into instrument memory

2.2 Operation

The instrument is set and controlled by five control keys located on the front panel. All programmable settings of the instrument are performed in three adjusting modes:

LIGHT	Simple programming menu - contains solely items necessary for instrument setting and is protected by optional number code
PROFI	Complete programming menu - contains complete instrument menu and is protected by optional number code
USER	User programming menu - may contain arbitrary items selected from the programming menu (LIGHT/PROFI), which determine the right (see or change) - access without password

All programmable parameters are stored in the EEPROM memory (they hold even after the instrument is switched off).



Complete instrument operation and setting may be performed via OM Link communication interface, which is a standard equipment of all instruments.

The operation program is freely accessible (www.orbit.merret.cz) and the only requirement is the purchase of OML cable to connect the instrument to PC. It is manufactured in version RS 232 and USB and is compatible with all ORBIT MERRET instruments. Another option for connection is with the aid of data output RS 232 or RS 485 (without the need of the OML cable).

The program OM LINK in „Basic“ version will enable you to connect one instrument with the option of visualization and archiving in PC. The OM Link „Standard“ version has no limitation of the number of instruments connected.

2.3 Options

Comparators are assigned to monitor one, two, three or four limit values with relay output. The user may select limits regime: LIMIT/DOSING/FROM-TO. The limits have adjustable hysteresis within the full range of the display as well as selectable delay of the switch-on in the range of 0...99,9 s. Reaching the preset limits is signalled by LED and simultaneously by the switch-on of the relevant relay.

Data outputs are for their rate and accuracy suitable for transmission of the measured data for further projection or directly into the control systems. We offer an isolated RS232 and RS485 with the ASCII or DIN MessBus protocol.

Analog outputs will find their place in applications where further evaluating or processing of measured data is required in external devices. We offer universal analog output with the option of selection of the type of output - voltage/current. The type of analog output corresponds with the displayed data and its type and range are selectable in Menu.

Measured data record is an internal time control of data collection. It is suitable where it is necessary to register measured values. Two modes may be used. FAST is designed for fast storage (40 records/s) of all measured values up to 8 000 records. Second mode is RTC, where data record is governed by Real Time with data storage in a selected time segment and cycle. Up to 250 000 values may be stored in the instrument memory. Data transmission into PC via serial interface RS232/485 and OM Link.

The instrument supply leads should not be in proximity of the incoming low-potential signals.

Contactors, motors with larger input power should not be in proximity of the instrument.

The leads into the instrument input (measured quantity) should be in sufficient distance from all power leads and appliances. Provided this cannot be secured it is necessary to use shielded leads with connection to ground (bracket E).

The instruments are tested in compliance with standards for use in industrial area, yet we recommend to abide by the above mentioned principles.

MEASURING RANGES

Type	Input I	Input U
DC	0...60/150/300/1 200 mV	
PM	0...5/20 mA/4...20 mA	$\pm 2/\pm 5/\pm 10/\pm 40$ V
OHM	0...0,1/1/10/100 k Ω	
RTD-Pt	Pt 100/Pt 500/ Pt 1 000	
RTD-Cu	Cu 50/100	
RTD-Ni	Ni 1 000/10 000	
T/C	J/K/T/E/B/S/R/N/L	
DU	Linear potentiometer (min. 500 Ω)	

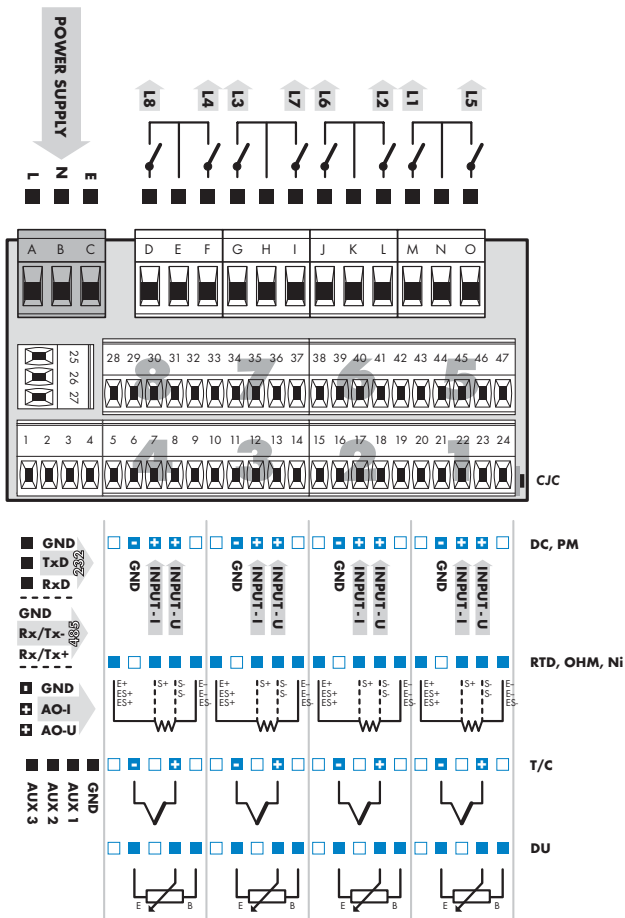

PROFI

SETTING

profi

- For expert users
- Complete instrument menu
- Access is password protected
- Possibility to arrange items of the „User“ menu
- Tree menu structure

LIGHT

SETTING

light

- For trained users
- Only items necessary for instrument setting
- Access is password protected
- Possibility to arrange items of the „User“ menu
- Linear menu structure

USER

SETTING

*profi light**user*

- For user operation
- Menu items are set by the user (Profi/Light) as per request
- Access is not password protected
- Optional menu structure either tree (PROFI) or linear (LIGHT)

4.1 Setting

The instrument is set and controlled by five control keys located on the front panel. All programmable settings of the instrument are performed in three adjusting modes:

- LIGHT** **Simple programming menu**
 - contains solely items necessary for instrument setting and is protected by optional number code
- PROFI** **Complete programming menu**
 - contains complete instrument menu and is protected by optional number code
- USER** **User programming menu**
 - may contain arbitrary items selected from the programming menu (LIGHT/PROFI), which determine the right (see or change)
 - access without password

All programmable parameters are stored in the EEPROM memory (they hold even after the instrument is switched off).

Complete instrument operation and setting may be performed via OM Link communication interface, which is a standard equipment of all instruments.

The operation program is freely accessible (www.orbit.merret.cz) and the only requirement is the purchase of OML cable to connect the instrument to PC. It is manufactured in version RS 232 and USB and is compatible with all ORBIT MERRET instruments.

Another option for connection is with the aid of data output RS 232 or RS 485 (without the need of the OML cable).

Scheme of processing the measured signal

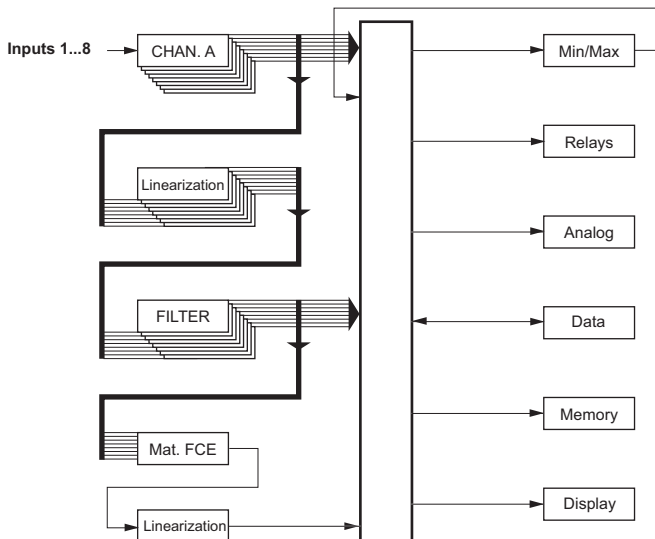

Setting and controlling the instrument is performed by means of 5 control keys located on the front panel. With the aid of these keys it is possible to browse through the operation menu and to select and set required values.

Indication of measured input

- red LED by green display
- green LED by red display

Function (green LED)

- M Min/max. value
- T Tare

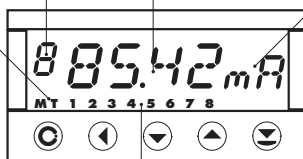

Measured value

(red/green LED)

Measuring units

(red/green LED)

Relay status

(red LED)

- ON the digit is lit
- OFF the digit is not lit
- OFF the digit is flashing > limits with restriction (hysteresis, delay)

Symbols used in the instructions

DC **PM**

DU **OHM** **RTD** **T/C** Indicates the setting for given type of instrument

DEF values preset from manufacture

symbol indicates a flashing light (symbol)

inverted triangle indicates the item that can be placed in USER menu

broken line indicates a dynamic item, i.e. it is displayed only in particular selection/version

after pressing the key the set value will not be stored

after pressing the key the set value will be stored

30 continues on page 30

Setting the decimal point and the minus sign

DECIMAL POINT

Its selection in the menu, upon modification of the number to be adjusted it is performed by the control key with transition beyond the highest decade, when the decimal point starts flashing. Positioning is performed by / .

THE MINUS SIGN

Setting the minus sign is performed by the key on higher decade. When editing the item subtraction must be made from the current number (e.g.: 013 > , on class 100 > -87)

Control keys functions

Key	Measurement	Menu	Setting numbers/selection
	access into USER menu	exit menu	quit editing
	programmable key function	back to previous level	move to higher decade
	programmable key function	move to previous item	move down
	programmable key function	move to next item	move up
	programmable key function	confirm selection	confirm setting/selection
			numeric value is set to zero
	access into LIGHT/PROFI menu		
	direct access into PROFI menu		
		configuration of an item for "USER" menu	
		determine the sequence of items in "USER - LIGHT" menu	

Setting items into „USER“ menu

- in **LIGHT** or **PROFI** menu
- no items permitted in **USER** menu from manufacture
- on items marked by inverted triangle

Legend is flashing - current setting is displayed



- item will not be displayed in USER menu
- item will be displayed in USER menu with the option of setting
- item will be solely displayed in USER menu

5.0 Setting "LIGHT"

LIGHT

Simple programming menu

- contains only items necessary for instrument setting and is protected by optional number code

SETTING LIGHT



- For capable users
- Only items necessary for instrument setting
- Access is password protected
- Possibility to arrange items of the „User“ menu
- Linear menu structure

Preset from manufacture

Password	"0"
Menu	LIGHT
USER menu	off
Setting the items	DEF

1428



PASSW. 0

Access password

!
Upon delay exceeding 60 s the programming mode is automatically discontinued and the instrument itself restores the measuring mode

Selecting input and range

INPUTS INP. 1 TYPE 1 °C MODE 1 60 m'

RTD OHM

Selecting projection and connection

CONE. 1 2-WIRE FORM.A 000.0

°C

CONE. 1 EXT. ITC C.J. TEM. 23 FORM.A 0000

DC PAM OHM DU

MIN.A 0 MAX.A 100 FORM.A 0000

Option - comparator

LIM.L1 10 LIM.L2 20 LIM.L3 30

LIM.L4 40 LIM.L5 60 LIM.L6 70

LIM.L7 80 LIM.L8 90

Option - Analog output

TYPE.A.O. I 20 MIN.A.O. 0 MAX.A.O. 100

Menu type

MENU LIGHT CALIB. YES RETURN TO MANUFACTURE CALIBRATION

Return to manufacture setting

SETTIN. TYPE RETURN TO MANUFACTURE SETTING

Calibration - only for "DU"

DU C.MIN YES C.MAX YES

Language selection

LANG. ENGL. N.PASS. 0

New password

Identification

I-ENT. YES DMU 408 1428

Return to measuring mode

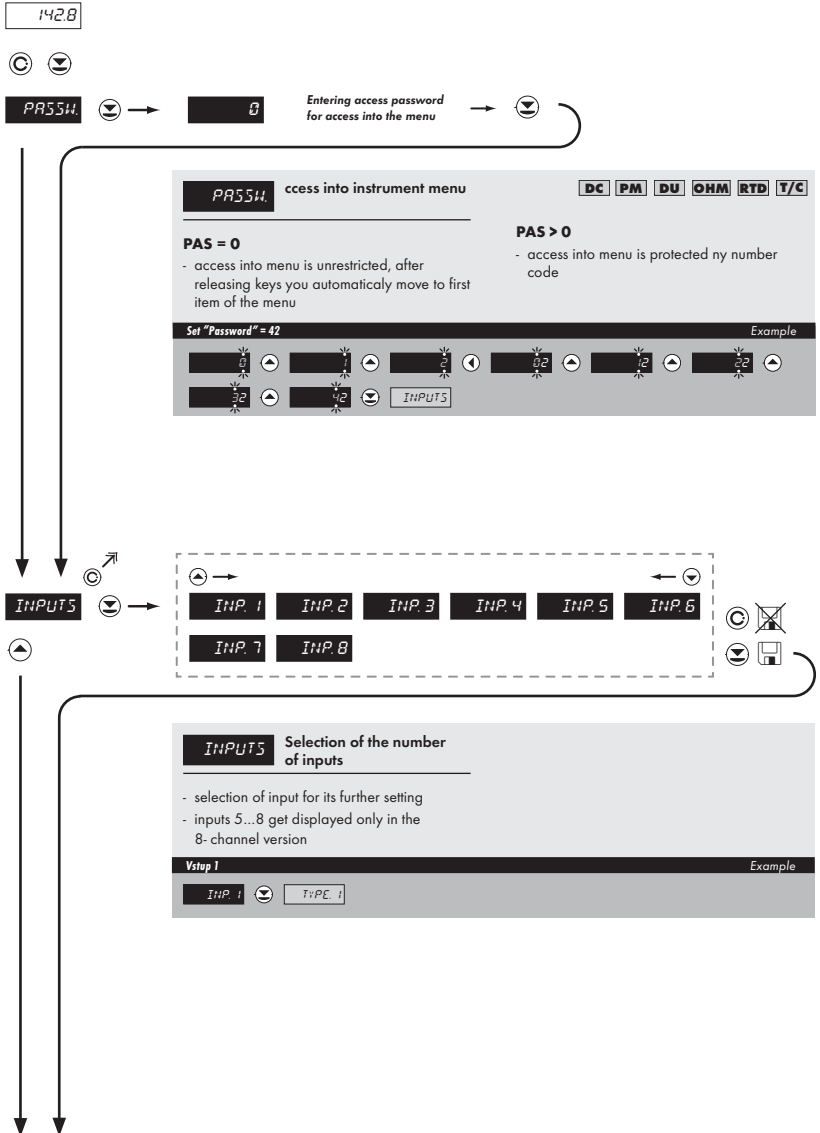



TYPE 1

Selection of the type of instrument

- primary selection of the type of instrument
- performs default setting **DEF** of values from manufacture, incl. calibration

TYPE 1	Menu	Type of instrument
	DC	DC voltmeter
	PM	Process monitor
	OHM	Ohmmeter
	RTD-Pt	Thermometer for sensors Pt
	RTD-Ni	Thermometer for sensors Ni
	TC	Thermometer for thermocouples
	DU	Display for lin. potentiometer
	RTD-Cu	Thermometer for sensors Cu

Type "PM"

Example

TC

HD: E 1

Type „DC“	16
Type "PM"	18
Type "DU"	20
Type "OHM"	22
Type "RTD-Pt"	24
Type "RTD-Cu"	26
Type "RTD-Ni"	28
Type "T/C"	30

Typ "DC"



MODE 1 Selection of the instrument measuring range

DEF = 60 mV

MODE 1	Menu	Measuring range
	60 mV	±60 mV
	150 mV	±150 mV
	300 mV	±300 mV
	1200mV	±1,2 V

Range ±150 mV Example

60 mV | 150 mV | MIN R



MIN R Setting display projection for minimum value of input signal

- position of the DP does not affect display projection
- the DP is automatically shifted after the value is confirmed

- range of the setting is -999...9999

DEF = 0

Projection for 0 mV > MIN A = 0 Example

0 | MIN R



MR: A Setting display projection for maximum value of input signal

- position of the DP does not affect display projection
- the DP is automatically shifted after the value is confirmed

- range of the setting is -999...9999

DEF = 100

Projection for 150 mV > MAXA = 3500 Example

100	100	00	200	300	400
500	0500	1500	2500	3500	FORN.A

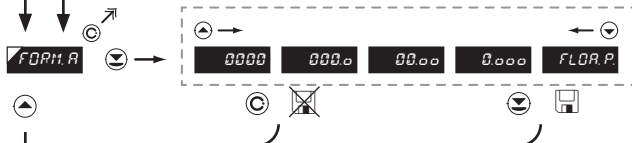

FORN.A Setting projection of the decimal point

DEF = 0000

- positioning of the DP is set here in the measuring mode

Projection of DP on display > 0000 Example

0000	000.0	MECHU
------	-------	-------

* subsequent item on the menu depends on instrument equipment

Type "PM"

110: E 1 → **0-5mA** **0-20mA** **4-20mA** **0-2V** **0-5V** **0-10V** **0-40V**

110: E 1 Selection of the instrument measuring range

DEF = 4 - 20 mA

MODE 1	Menu	Range
	0-5mA	0...5 mA
	0-20mA	0...20 mA
	4-20mA	4...20 mA
	0.2 V	±2 V
	0.5 V	±5 V
	0-10 V	±10 V
	0-40 V	±40 V

Range 0...20 mA Example

4-20mA **0-20mA** **MIN A**

MIN A Setting for minimum input signal

0

MIN A Setting display projection for minimum value of input signal

- position of the DP does not affect display projection
- the DP is automatically shifted after the value is confirmed

- range of the setting is -999...9999

DEF = 0

Projection for 0 mA > MIN A = -25 Example

0 **0** **0** **0** **0** **0** **0** **0** **0** **0**

0.5 **0.5** **0.5** **0.5** **0.5** **0.5** **0.5** **0.5** **0.5** **0.5**

11A = A



MRA: A Setting display projection for maximum value of input signal

- position of the DP does not affect display projection
- the DP is automatically shifted after the value is confirmed

- range of the setting is -999...9999

DEF = 100

Projection for 20 mA > MAX A = 2500 Example

100	100	100	200	300	400
500	500	500	500	FORM.A	

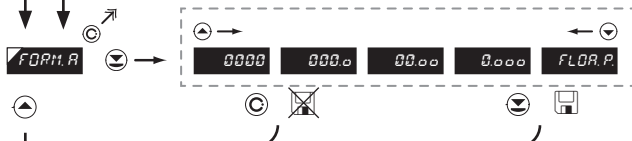

FORM.A Setting projection of the decimal point

DEF = 0000

- positioning of the DP is set here in the measuring mode

Projection of DP on display > 0000 Example

0000	000.0	MENU	
------	-------	------	--

* subsequent item on the menu depends on instrument equipment

Type "DU"



MIN A Setting display projection for minimum value of input signal

- position of the DP does not affect display projection
- the DP is automatically shifted after the value is confirmed

- range of the setting is -999...9999

DEF = 0

Projection for the beginning > MIN A = 0 Example



MAX A Setting display projection for maximum value of input signal

- position of the DP does not affect display projection
- the DP is automatically shifted after the value is confirmed

- range of the setting is -999...9999

DEF = 100

Projection for the end > MAX A = 5000 Example

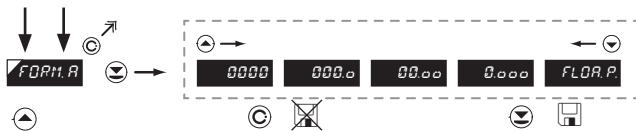

FORM.A Setting projection of the decimal point **DEP** = 0000

- positioning of the DP is set here in the measuring mode

Projection of DP on display > 000e Example

0000 [up] 000.0 [down] MENU * subsequent item on the menu depends on instrument equipment

32

Calibration of the beginning and the end of range of linear potentiometer is on page 37

Type "OHM"

MODE 1

100 R 1 k 10 k 100 k

MODE 1

Menu	Measuring range
100 R	0...100 Ω
1 k	0...1 kΩ
10 k	0...10 kΩ
100 k	0...100 kΩ

DEF = 100 Ω

Range 0...10 kΩ Example

100 R 1 k 10 k CONE. 1

CONE. 1

2-WIRE 3-WIRE 4-WIRE

CONE. 1

Selection of the type of sensor connection

DEF = 2-WIRE

Menu	Connection
2-WIRE	2-wire
3-WIRE	3-wire
4-WIRE	4-wire

Type of connection - 3 wire > CONE. 1 = 3-WIRE Example

2-WIRE 3-WIRE MIN A

MIN A

Setting for minimum input signal

DEF = 0

MIN A

Setting display projection for minimum value of input signal

- position of the DP does not affect display projection
- the DP is automatically shifted after the value is confirmed

DEF = 0

Projection for 0 Ohm > MIN A = 0 Example

0 MIN A



11R: A Setting display projection for maximum value of input signal

- position of the DP does not affect display projection
- the DP is automatically shifted after the value is confirmed

- range of the setting is -999...9999

DEF = 100

Projection for 10 LOhm > MAX A = 1000 Example

100 100 00 000 0000 000

FDR: A

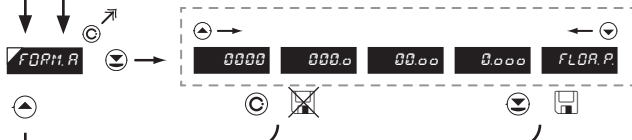

FDR: A Setting projection of the decimal point

- positioning of the DP is set here in the measuring mode

DEF = 0000

Projection of DP on display > 000e Example

0000 000.0 00.00 0.000 FLD: A

MENU * subsequent item on the menu depends on instrument equipment

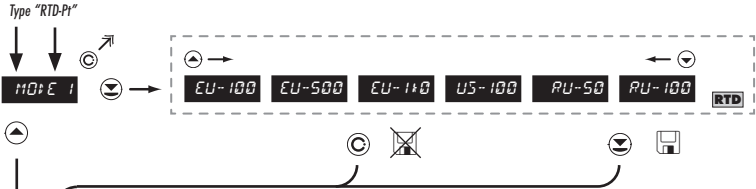

MO: E 1 Selection of instrument measuring range

DEF = Pt 100

Menu	Measuring range
EU-100	Pt 100 (3 850 ppm/°C)
EU-500	Pt 500 (3 850 ppm/°C)
EU-1k0	Pt 1000 (3 850 ppm/°C)
US-100	Pt 100 (3 920 ppm/°C)
RU-50	Pt 50 (3 910 ppm/°C)
RU-100	Pt 100 (3 910 ppm/°C)

MODE 1

Range - Pt 1 000 > MODE 1 = EU-1k0 Example

EU-100 EU-500 EU-1k0 CODE. 1



CODE. 1 Selection of the type of sensor connection

DEF = 2-WIRE

Menu	Connection
2-WIRE	2-wire
3-WIRE	3-wire
4-WIRE	4-wire

CODE. 1

Type of connection - 3 wire > CODE. 1 = 3-WIRE Example

2-WIRE 3-WIRE FORM A



FORM.A Setting projection of the decimal point **DEF** = 0000

- positioning of the DP is set here in the measuring mode

Projection of DP on display > 000e *Example*

0000	▲	000.e	▼	MENU	* subsequent item on the menu depends on instrument equipment
------	---	-------	---	------	---

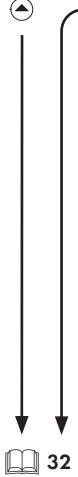

Type "RTD-Cu"



MO: E 1 Selection of instrument measuring range

DEF = 428-50

MODE 1	Menu	Measuring range
	428-50	Cu 50 (4 285 ppm/°C)
	428-100	Cu 100 (4 285 ppm/°C)
	426-50	Cu 50 (4 260 ppm/°C)
	426-100	Cu 100 (4 260 ppm/°C)

Range - Cu 50/4 260 ppm > MODE. 1 = 426-50 Example

428-50 428-0.1 426-50 CONE. 1



CONE. 1 Selection of the type of sensor connection

DEF = 2-WIRE

CONE. 1	Menu	Connection
	2-WIRE	2-wire
	3-WIRE	3-wire
	4-WIRE	4-wire

Type of connection - 3-wire > CONE. 1 = 3-WIRE Example

2-WIRE 3-WIRE FORM. A



FORM.A

Setting projection of the decimal point

- positioning of the DP is set here in the measuring mode

DEP = 0000

Projection of DP on display > 000o

Example

0000

▲
▼

000.o

▲
▼

MENU

* subsequent item on the menu depends on instrument equipment



Type "RTD-Ni"

MO: E 1

5.0-1k 6.2-1k 5.0-10k 6.2-10k RTD



MO: E 1 Selection of instrument measuring range

DEF = Ni 1 000 - 5 000 ppm/°C

Menu	Measuring range
5.0-1k	Ni 1 000 (5 000 ppm/°C)
6.2-1k	Ni 1 000 (6 180 ppm/°C)
5.0-10k	Ni 10 000 (5 000 ppm/°C)
6.2-10k	Ni 10 000 (6 180 ppm/°C)

Rangr - Ni 10 000/5 000 ppm > MODE 1 = 5.0-10k

Example

5.0-1k 6.2-1k 5.0-10k CONE. 1

CONE. 1

2-WIRE 3-WIRE 4-WIRE



CONE. 1 Selection of the type of sensor connection

DEF = 2-WIRE

Menu	Connection
2-WIRE	2-wire
3-WIRE	3-wire
4-WIRE	4-wire

Type of connection - 3 wire > CONE. 1 = 3-WIRE

Example

2-WIRE 3-WIRE 4-WIRE FORM R



FORM.A Setting projection of the decimal point **DEF** = 0000

- positioning of the DP is set here in the measuring mode

Projection of DP on display > 0000 *Example*

0000	▲	000.0	▼	MENU	* subsequent item on the menu depends on instrument equipment
------	---	-------	---	------	---



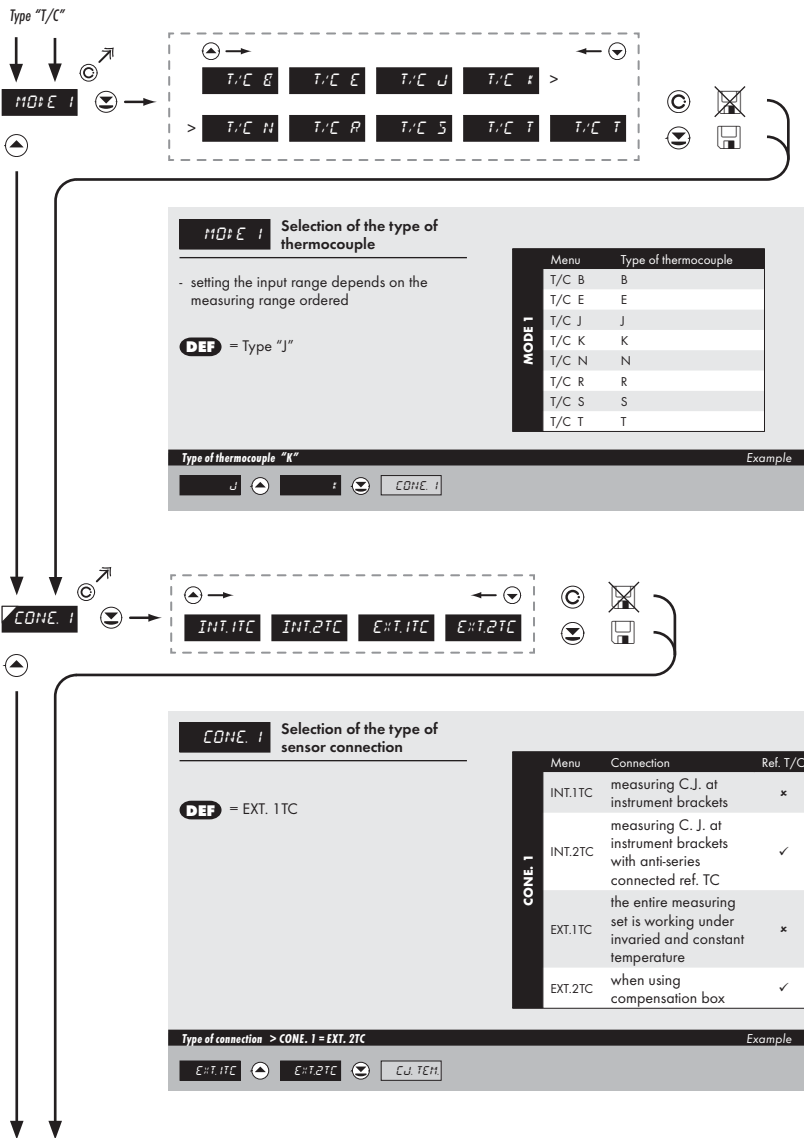



C.J. TEM. Setting temperature of cold junction DEF = 23

- range 0...99°C with compensation box

- položka je přístupná pouze při nastavení parametru 1. vstupu

Setting temperature of cold junction > C.J. TEM. = 35 Example

23 ▲ 24 ▲ 25 ◀ 25 ▲ 35 ▼ FORM.A



FORM.A Setting projection of the decimal point DEF = 0000

- positioning of the DP is set here in the measuring mode

Projection of DP on display > 0000 Example

0000 ▲ 000.0 ▼ MENU * subsequent item on the menu depends on instrument equipment

!
For thermocouple type "B" the items CONE. 1 and C.J. TEM. are not available

!
Method and procedure of setting the cold junctions is described in separate chapter on page 76

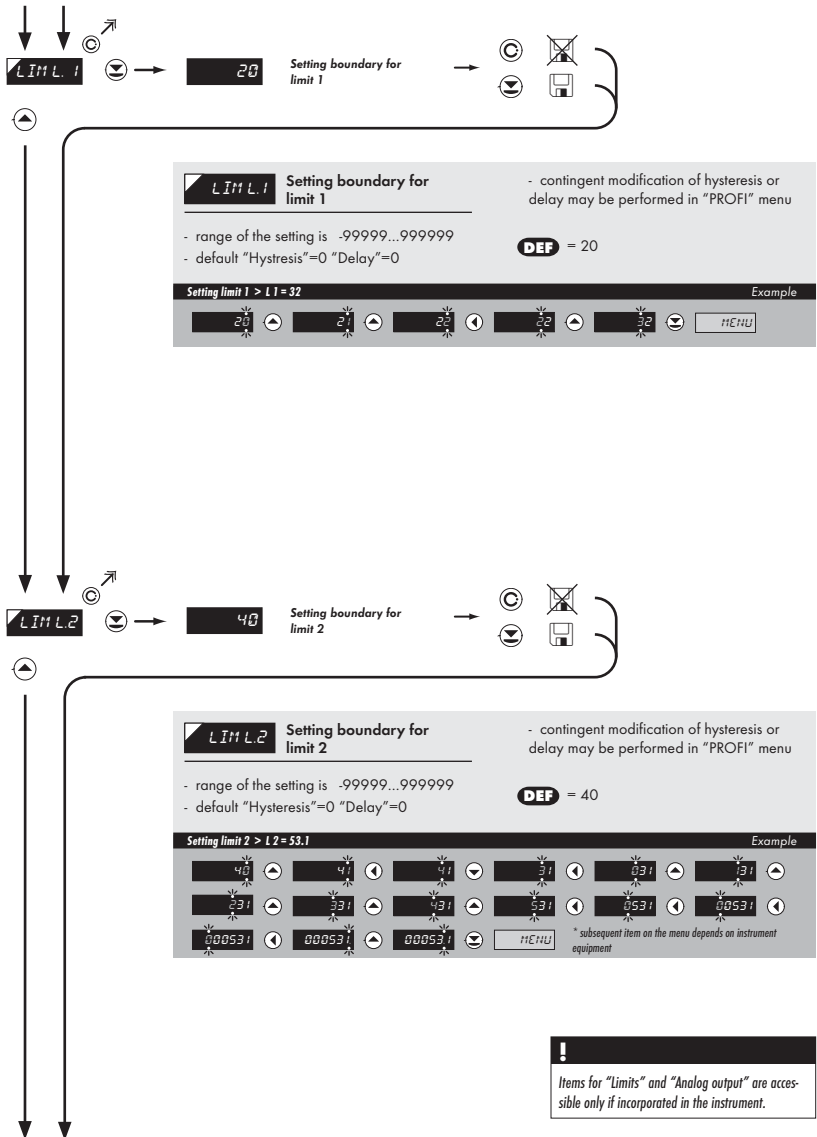



LIM L3 Setting boundary for limit 3

- range of the setting is .99999...999999
- default "Hysteresis"=0 "Delay"=0

DEF = 60

Setting limit 3 > L3 = 85 Example

80	81	82	83	84	85
85	85	85	85	85	85

* subsequent item on the menu depends on instrument equipment



LIM L4 Setting boundary for limit 4

- range of the setting is .99999...999999
- default "Hysteresis"=0 "Delay"=0

DEF = 80

Setting limit 4 > L4 = 103 Example

80	81	82	83	83	83	83
83	83	83	83	83	83	83

* subsequent item on the menu depends on instrument equipment

!
If instrument with 8 relays was ordered, after setting Limit 4 follows the setting of limits 5...8.

TYP.A.O. Setting the type of analog output

Menu	Range	Description
0-20mA	0...20 mA	
E. 4-20mA	4...20 mA	with indication of error statement (<3,6 mA)
4-20mA	4...20 mA	
0.5mA	0...5 mA	
0.2 V	0...2 V	
0.5 V	0...5 V	
0-10 V	0...10 V	

DEF = 4...20 mA

Type of analog output - 0...10 V > TYP.A.O. = 0-10 V Example

4-20mA 0-5mA 0-2V 0-5V 0-10V **MIN.A.O.**

MIN.A.O. Assigning the display value to the beginning of the AO range

DEF = 0

- range of the setting is -999...9999

Display value for the beginning of the AO range > MIN.A.O. = 0 Example

!

Items for "Limits" and "Analog output" are accessible only if incorporated in the instrument.

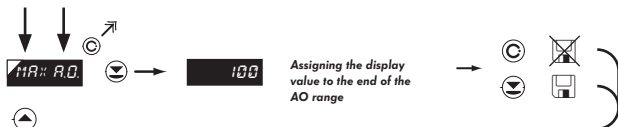

11A:: R.O. Assigning the display value to the end of the AO range **DEF** = 100

- range of the setting is -999...9999

Display value for the end of the AO range > MAX A.O. = 120 Example

100 (←) 100 (→) 110 (→) 120 (←) MENU

Displayed only with options > **Analog output**

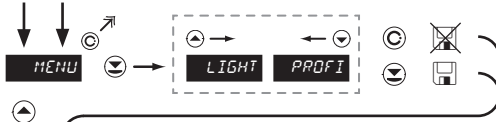

MENU Setting the menu type
LIGHT/PROFI

LIGHT > menu LIGHT, a simple menu, which contains only the most essential items necessary for instrument setting
> linear tree structure

PROFI > menu PROFI, a complete menu for complete instrument setting
> tree menu structure

DEF = LIGHT

Menu LIGHT > MENU = LIGHT Example

LIGHT CALIB



CALIB Restoration of manufacture calibration

- in the event of error calibration it is feasible to restore manufacture calibration.

Prior to execution of any modifications you will be asked to confirm your selection. (YES)

Restoration of manufacture setting > CALIB. Example

CALIB YES SETTING

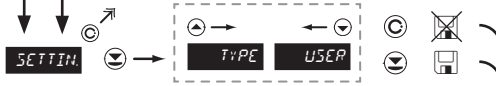

SETTING Restoration of manufacture instrument setting

- in the event of error setting the manufacture setting may be restored

- restoration is performed for the currently selected type of the instrument input (select "TYPE")

- provided you stored your user setting in the "PROFI" menu, it may also be restored (select "USER")

- loading manufacture calibration and primary setting of items on the menu (DEF)

Restoration of manufacture setting > SETTING. Example

SETTING TYPE USER LANG * subsequent item on the menu depends on instrument type, for "DU" > "K.MIN"

Type "DC"		38
Type "PM"		38
Type "DU"		37
Type "OHM"		38
Type "RTD-Pt"		38
Type "RTD-Cu"		38
Type "RTD-Ni"		38
Type "T/C"		38



C.MIN Calibration of input range - the potentiometer traveller in initial position Only for type "DU"

- the inputs for calibration always include only active inputs, i.e. those that are ser for "MOD > DU".
- prior confirming the flashing "YES" sign the potentiometer traveller has to be in given idle position

Calibration of the beginning of the range > C. MIN Example

YES **C.MIN**



C.MAX Calibration of input range - the potentiometer traveller in end position Only for type "DU"

- the inputs for calibration always include only active inputs, i.e. those that are ser for "MOD > DU".
- prior confirming the flashing "YES" sign the potentiometer traveller has to be in given idle position

Calibration of the end of the range > C. MAX Example

YES **C.MAX**



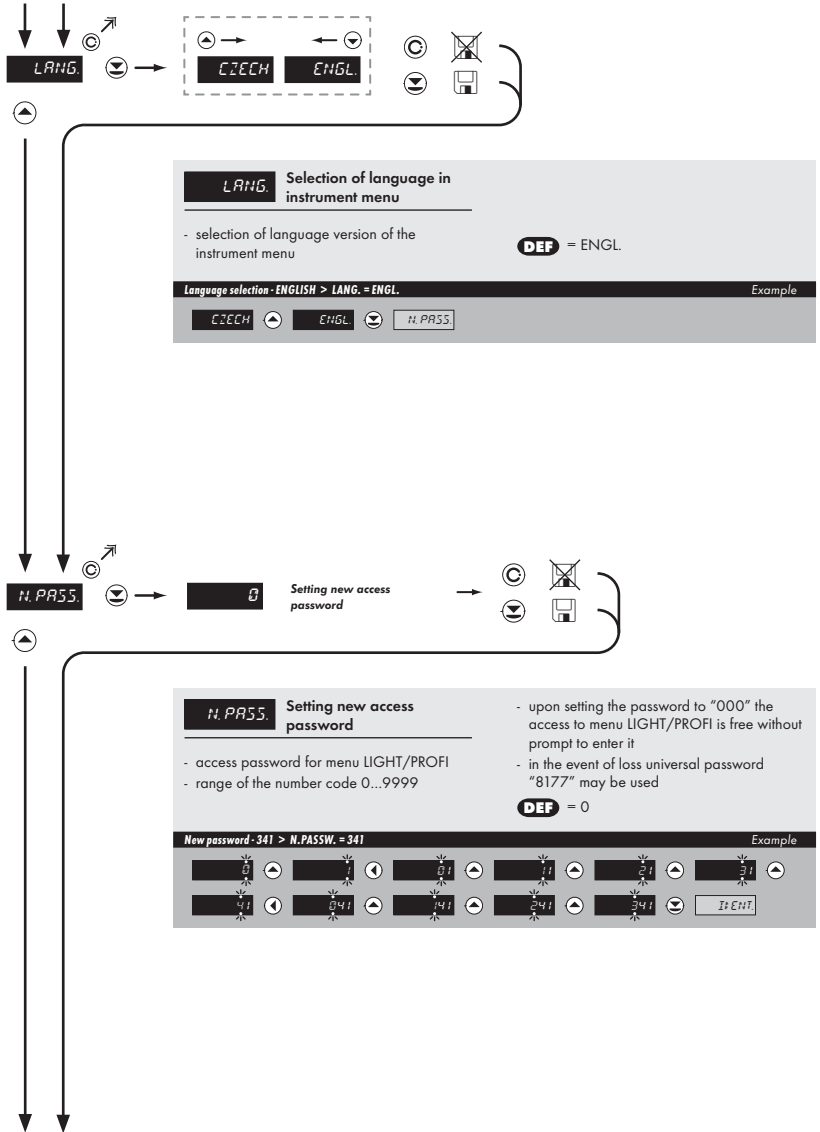

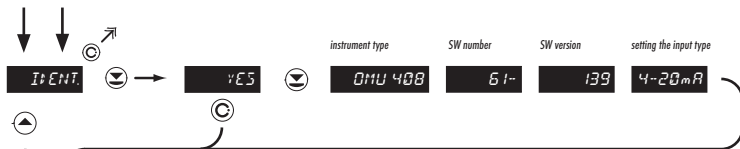

It ENT. Instrument SW version

- the display shows the type of instrument indication, SW number, SW version and current input setting (Mode)

- if SW version contains a letter in first position, then it is a customer SW
- after the identification is completed the menu is automatically exited and the instrument restores the measuring mode

1428

Return to measuring mode

6.0

Setting "PROFI"

PROFI

Complete programming menu

- contains complete instrument menu and is protected by optional number code
- designed for expert users
- preset from manufacture is menu **LIGHT**

 SETTING
 PROFI

- For expert users
- Complete instrument menu
- Access is password protected
- Possibility to arrange items of the „User“ menu
- Tree menu structure

Switching over to "PROFI" menu



- temporary switch-over to **PROFI** menu, which is suitable to edit a few items
- after quitting **PROFI** menu the instrument automatically switches to **LIGHT** menu
- access is password protected (if it was not set under item N. PASS. =0)



- access into **LIGHT** menu and transition to item „MENU“ with subsequent selection of „PROFI“ and confirmation
- after re-entering the menu the **PROFI** type is active
- access is password protected (if it was not set under item N. PASS. =0)

6.1 Setting "PROFI" - INPUT

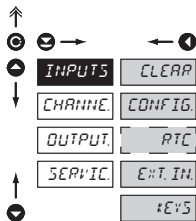

The primary instrument parameters are set in this menu

CLEAR	Resetting internal values
CONFIG	Selection of measuring range and parameters
RTC	Setting date and time for option with RTC
EXT. IN	Setting external inputs functions
EYS	Assigning further functions to keys on the instrument

6.1.1 Resetting internal values

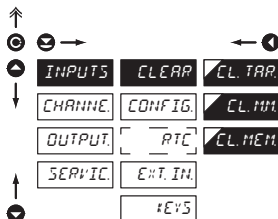

CLEAR	Resetting internal values
CL.TAR	Tare resetting
CL.MIN	Resetting min/max value
CL.MEM	Resetting the instrument memory

- resetting memory for the storage of minimum and maximum value achieved during measurement
- resetting memory with data measured in the "FAST" or "RTC" modes
- not in standard equipment

6.1.2a Selection of measuring rate

↑

⊙ ↻ → ← ①

↑

INPUTS CLEAR PER: /S 40.0

CHANNEL CONFIG INPUTS 20.0

OUTPUT [PTC] IN. MOD. 10.0

SERVIC. EXT. IN. SWITCH 5.0 **DEF**

#EVS TIM. PR. 2.0

INP. 1 1.0

INP. 2 0.5

INP. 3 0.2

INP. 4 0.1

[INP. 5]

[INP. 6]

[INP. 7]

[INP. 8]

↓

PER: /S Selection of measuring rate

40.0	40,0 measurements/s
20.0	20,0 measurements/s
10.0	10,0 measurements/s
5.0	5,0 measurements/s
2.0	2,0 measurements/s
1.0	1,0 measurements/s
0.5	0,5 measurements/s
0.2	0,2 measurements/s
0.1	0,1 measurements/s

6.1.2b Selection of number of active measuring inputs

↑

⊙ ↻ → ← ①

↑

INPUTS CLEAR PER: /S 1 INP.

CHANNEL CONFIG INPUTS 2 INP. **DEF**

OUTPUT [PTC] IN. MOD. 3 INP.

SERVIC. EXT. IN. SWITCH 4 INP.

#EVS TIM. PR. 5 INP.

INP. 1 6 INP.

INP. 2 7 INP.

INP. 3 8 INP.

INP. 4

[INP. 5]

[INP. 6]

[INP. 7]

[INP. 8]

↓

INP. 2 Selection of number of active inputs

- the number of active measuring inputs influences the resulting measuring rate

1 INP.	1 active measuring input
2 INP.	2 active measuring inputs
3 INP.	3 active measuring inputs
4 INP.	4 active measuring inputs
5 INP.	5 active measuring inputs
6 INP.	6 active measuring inputs
7 INP.	7 active measuring inputs
8 INP.	8 active measuring inputs

6.1.2c Selection of measuring mode

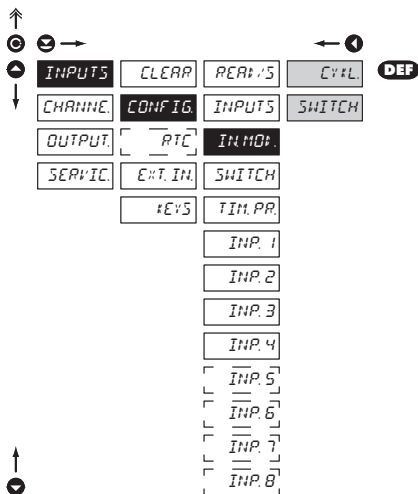
**IN.MOD.** Selection of measuring mode

CYCL Cyclic measurement on all inputs

- number of active measuring inputs is set in the INPUTS/CONFIG/OUTPUTS
- projection of measuring inputs is set in the menu INPUTS/CONFIG/SWITCHIN.
- the cycle option rather significantly affects the measuring rate and depends on the number of active inputs (real measuring rates are listed in chapter Technical data)

SWITCH Instrument performs measuring only on the active input

- projection of measuring inputs is set in the menu INPUTS/CONFIG/SWITCH.

6.1.2d Selection of measuring inputs switching

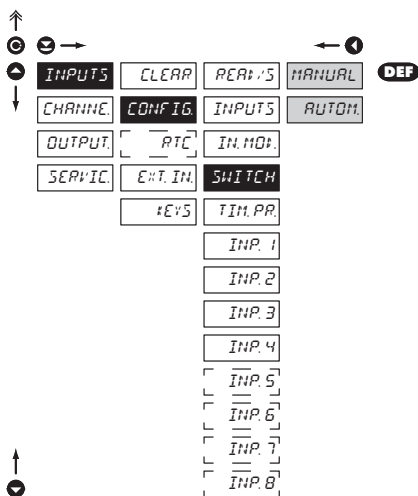
**IN.MOD.** Selection of measuring inputs switching

MANUAL Manual inputs switching

- inputs switching is controlled by selected key on the front panel or selected external input

AUTOM Automatic inputs switching

- inputs switching is automatic with time period set in "TIM.SW."

6.1.2e Setting period for measuring inputs switching

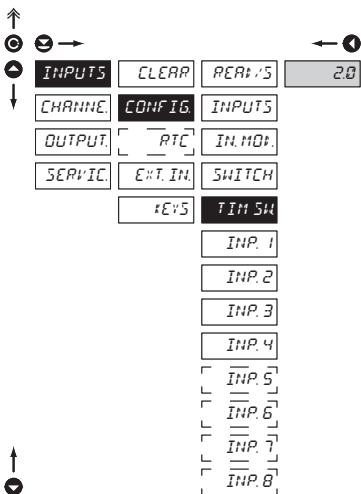

TIM SW Setting period for inputs switching

- setting time period for projection of channels in automatic mode of inputs switching ("AUTOM.")
- range of setting 0,5...99,9 s
- **DEF** = 2 s

6.1.2f Selection of „instrument“ type for Input 1

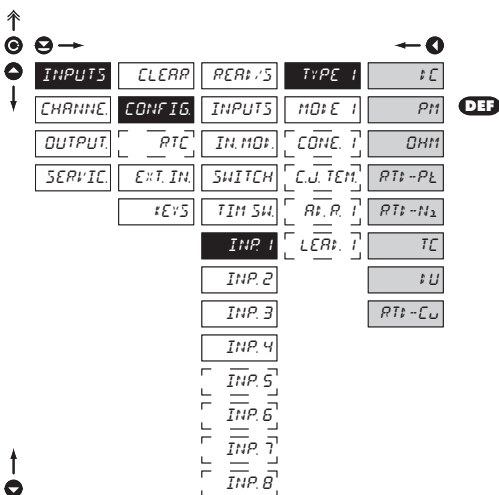

TYPE 1 Selection of „instrument“ type for Input 1

- selection of particular type of "instrument" is bound to relevant dynamic items

IC	DC voltmeter
PH	Process monitor
OHM	Ohmmeter
RT1-P1	Thermometer for Pt xxx
RT1-N1	Thermometer for Ni xxxx
TC	Thermometer pro thermocouples
I.U	Display for linear potentiometers
RT1-CU	Thermometer for Cu xxx

6.1.2g Selection of measuring range for Input 1

↑

⊖ →

⊕ ↓

INPUTS	CLEAR	REAR'S	TYPE 1	DC	60mV	OHM	100R	DEF
CHANNEL	CONFIG	INPUTS	MODE 1		150mV		1k	
OUTPUT	PTC	INH.MOD	COHE. 1		300mV		10k	
SERVIC.	EXT.IN.	SWITCH	EJ.TEM.		1200mV		100k	
	KEYS	TIM SW.	Ak.R.					
		INP. 1	LEA. 1					
		INP. 2		PM	0-5mA			
		INP. 3			0-20mA			
		INP. 4		DEF	4-20mA			
		INP. 5			0-2V			
		INP. 6			0-5V			
		INP. 7			0-10V			
		INP. 8			0-40V			
				RTD-Pt	EU-100	RTD-Cu	420-50	DEF
				DEF	EU-500	420-0.1		
					EU-1k0	426-50		
					U5-100	426-0.1		
					RU-50			
					RU-100			
						T/C		
						T/C 0		
						T/C E		
				RTD-Ni	T/C J	T/C J		DEF
				DEF	5.0-1k	T/C I		
					6.2-1k	T/C H		
					5.0-10k	T/C P		
					6.2-10k	T/C S		
						T/C T		
				DU	T/C T			
				DEF	LIN.POT.	T/C L		

↑

⊖

MODE 1 Selection of instrument measuring range - INP 1

Menu	Measuring range
DC	
60 mV	±60 mV
150 mV	±150 mV
300 mV	±300 mV
1200mV	±1.2 V
PM	
Menu	Measuring range
0.5mA	0...5 mA
0.20mA	0...20 mA
4.20mA	4...20 mA
0.2 V	±2 V
0.5 V	±5 V
0.10 V	±10 V
0.40 V	±40 V
OHM	
Menu	Measuring range
100 R	0...100 Ω
1 k	0...1 kΩ
10 k	0...10 kΩ
100 k	0...100 kΩ
AUTO	Automatická změna rozsahu
RTD-Pt	
Menu	Measuring range
EU-100	Pt 100 (3 850 ppm/°C)
EU-500	Pt 500 (3 850 ppm/°C)
EU-1k0	Pt 1000 (3 850 ppm/°C)
US-100	Pt 100 (3 920 ppm/°C)
RU-50	Pt 50 (3 910 ppm/°C)
RU-100	Pt 100 (3 910 ppm/°C)
RTD-Ni	
Menu	Measuring range
5.0-1k	Ni 1 000 (5 000 ppm/°C)
6.2-1k	Ni 1 000 (6 180 ppm/°C)
5.0-10k	Ni 10 000 (5 000 ppm/°C)
6.2-10k	Ni 10 000 (6 180 ppm/°C)
RTD-Cu	
Menu	Measuring range
428-50	Cu 50 (4 280 ppm/°C)
428-0.1	Cu 1 00 (4 280 ppm/°C)
426-50	Cu 50 (4 260 ppm/°C)
426-0.1	Cu 100 (4 260 ppm/°C)
T/C	
Menu	Type of thermocouple
T/C B	B
T/C E	E
T/C J	J
T/C K	K
T/C N	N
T/C R	R
T/C S	S
T/C T	T
T/C L	L

*
Setting procedure is identical also for inputs 2...8

6.1.2h Selection of type of sensor connection

RTD **OHM** **T/C**

Navigation icons: ↑, ↓, ←, →, [Home], [Back]

INPUTS	CLEAR	REAR.S	TYPE 1	2-WIRE	DEF
CHANNE	CONFIG	INPUTS	MODE 1	3-WIRE	
OUTPUT	RTC	IN.MD	COE. 1	4-WIRE	
SERVIC	EXT. IN	SWITCH	RI. P. 1		
	KEYS	TIM SW	LEA. 1		
		INP 1			
		INP.2			
		INP.3			
		INP.4			
		INP.5			
		INP.6			
		INP.7			
		INP.8			

Navigation icons: ↑, ↓, ←, →, [Home], [Back]

INPUTS	CLEAR	REAR.S	TYPE 1	INT. ITC	DEF
CHANNE	CONFIG	INPUTS	MODE 1	INT.2TC	
OUTPUT	RTC	IN.MD	COE. 1	EXT. ITC	
SERVIC	EXT. IN	SWITCH	C.J. TEM	EXT.2TC	
	KEYS	TIM SW			
		INP 1			
		INP.2			
		INP.3			
		INP.4			
		INP.5			
		INP.6			
		INP.7			
		INP.8			

COE. 1 Selection of type of sensor connection

RTD **OHM**

2-WIRE 2-wire connection

3-WIRE 3-wire connection

4-WIRE 4-wire connection

T/C

INT. ITC Measurement without reference thermocouple
- measuring cold junction at instrument brackets

INT.2TC Measurement with reference thermocouple
- measuring cold junction at instrument brackets with anti-series connected reference thermocouple

EXT. ITC Measurement without reference thermocouple
- the entire measuring set is working under invaried and constant temperature

EXT.2TC Measurement with reference thermocouple
- when using compensation box

!
Setting for "T/C" is accessible only for 1st input

!
Method and procedure of setting the cold junctions is described in separate chapter on page 84

!
For thermocouple type "B" the items COE. and C.J. TEM. are not available

Setting procedure is identical also for inputs 2...8

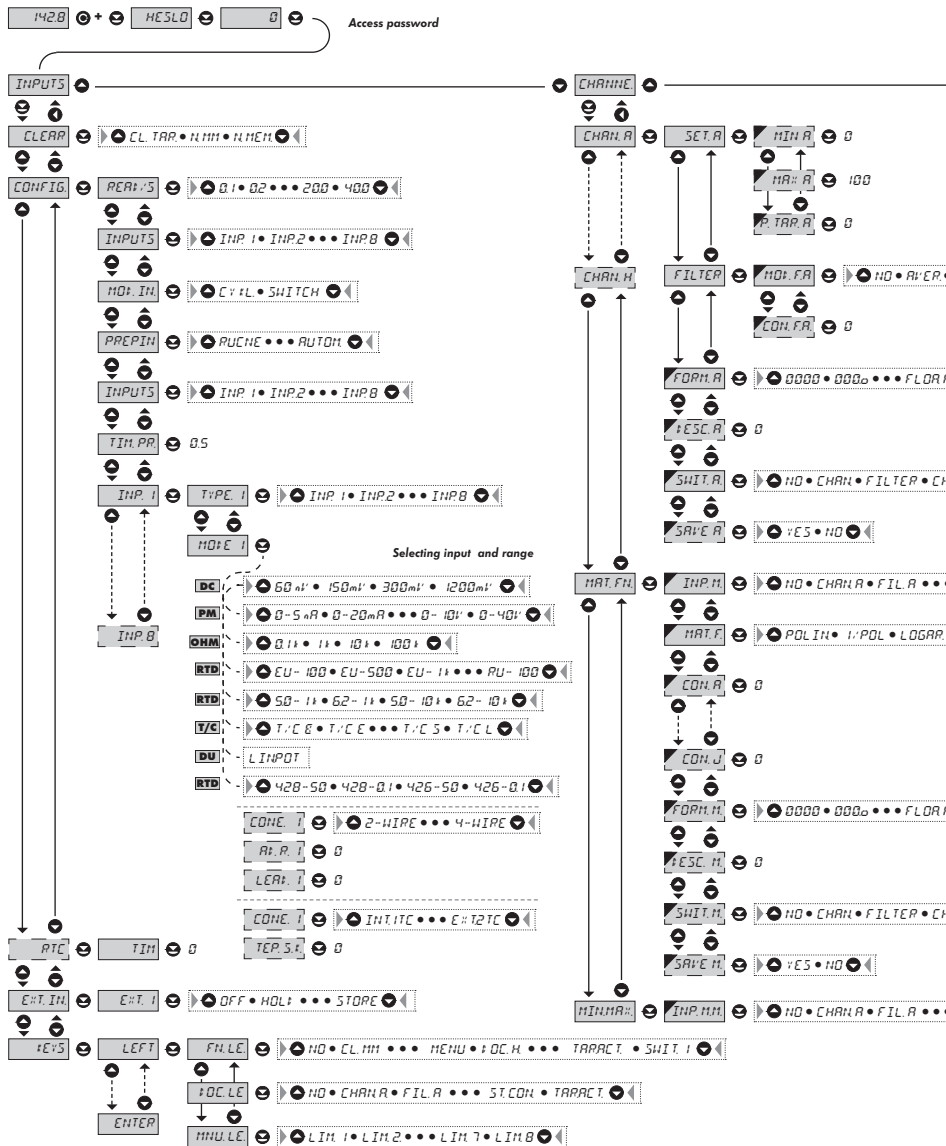

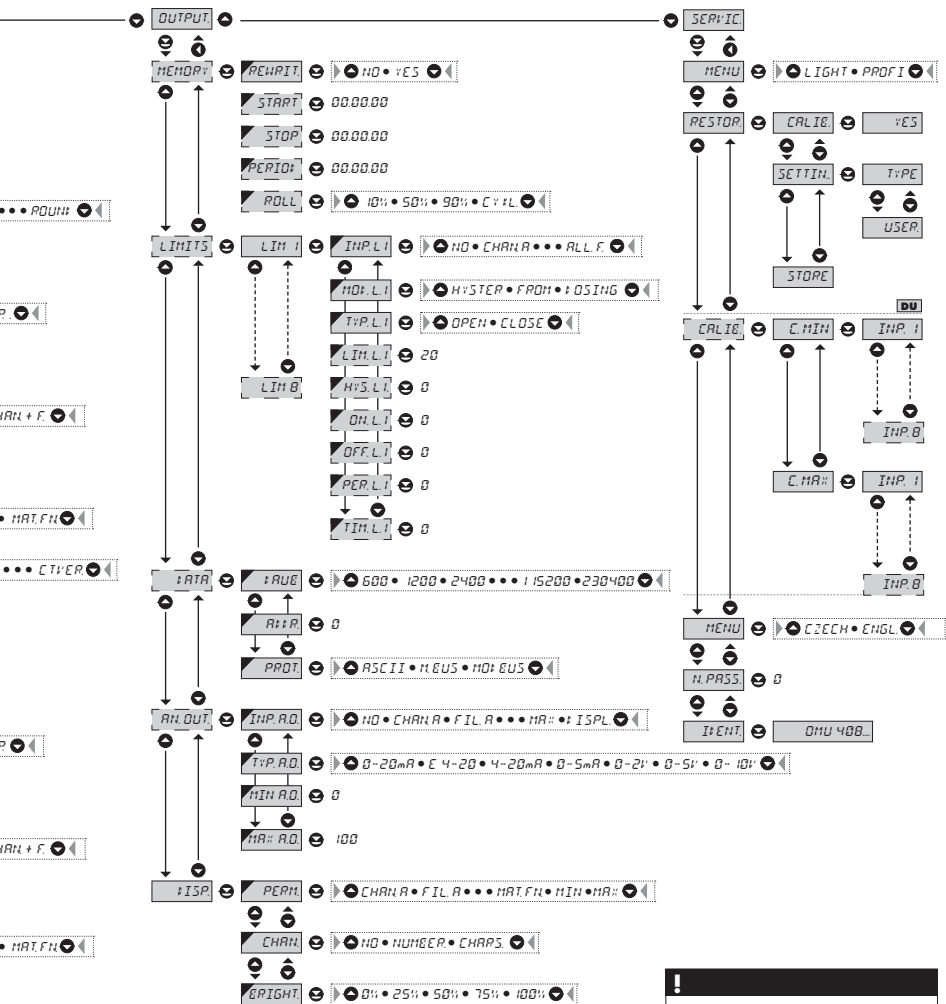

!
Upon delay exceeding 60 s the programming mode is automatically discontinued and the instrument itself restores the measuring mode

6.1.2i Setting temperature of cold junction

T/C

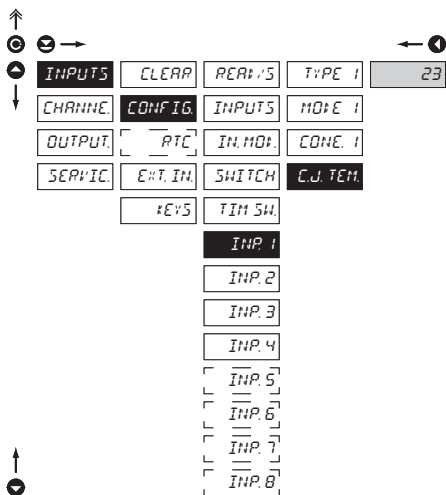

C.J. TEM. Setting temperature of cold junction

- range 0...99°C with compensation box

- DEF = 23°C

! Setting for "T/C" is accessible only for 1st input

6.1.2j Compensation of 2-wire conduct

RTD OHM

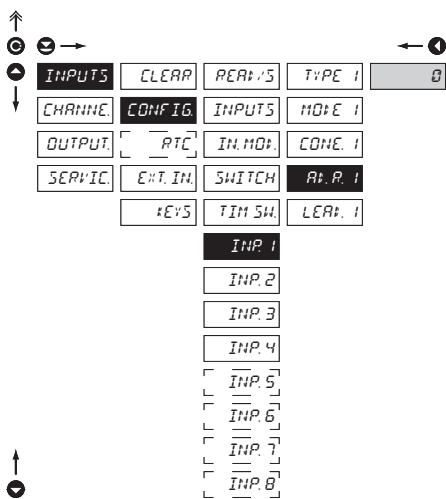

Rt. R. 1 Offset of the beginning of the measuring range

- in cases when it is necessary to offset the beginning of the range by certain value, e.g. while using sensor in measuring head

- entered directly in Ohm (0...9999)

- DEF = 0

* Setting procedure is identical also for inputs 2...8

6.1.2k Compensation of 2-wire conduct

RTD **OHM**

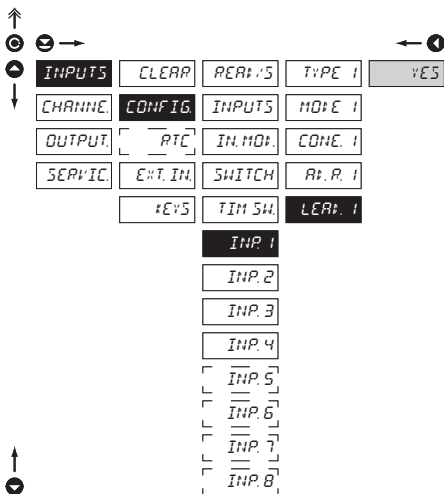

LER: 1 Compensation of 2-wire conduct

- for measurement accuracy it is necessary to perform compensation of conduct always in case of 2-wire connection
- prior confirmation of the displayed prompt „YES“ it is necessary to substitute the sensor at the end of the conduct by a short-circuit
- **DEF** = 0

*

Setting procedure is identical also for inputs 2...8

6.1.3 Setting the real time clock

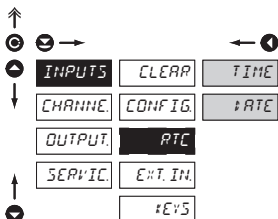

RTC Setting the real time clock (RTC)

TIME Time setting

- format 23.59.59

DATE Date setting

- format DD.MM.YY

6.1.4a External input function selection

↑

⊙ →

⬆

INPUTS	CLEAR	EXT. 1	OFF
CHANNEL	CONFIG	EXT. 2	HOLD
OUTPUT	PTC	EXT. 3	LOCK 1
SERVIC.	EXT. IN.	M. HOLD	E. PASS
	KEYS		TARE A
			TARE B
			TARE C
			TARE 1
			TARE E
			TARE F
			TARE G
			TARE H
			TARALL
			TARACT
			CL.MM
			CL.TA
			CL.TB
			CL.TC
			CL.TD
			CL.TE
			CL.TF
			CL.TG
			CL.TH
			CT.ALL
			CT.ACT
			SWIT. 1
			SWIT. 2
			SWIT. 3
			STORE

⬇

Table with external inputs control

Kanál	Ext 1	Ext 2	Ext 3
FIL. A	0	0	
FIL. B	0	1	
FIL. C	1	0	
FIL. D	1	1	
FIL. E	0	0	1
FIL. F	0	1	1
FIL. G	1	0	1
FIL. H	1	1	1

EXT. IN. External input function selection

- OFF Input is off
- HOLD Activation of HOLD
- LOCK 1 Locking keys on the instrument
- E. PASS Activation of locking access into programming menu LIGHT/PROFI
- TARE - Tare activation > by individual inputs
- TARALL Tare activation on all channels
- TARACT Tare activation on current input
- CL.MM Resetting min/max value
- CL.T- Clear tare > by individual inputs
- CT.ALL Clear tare on all channels
- CT.ACT Clear tare on current input
- SWIT. 1 Gradual switching of inputs projection
- SWIT. 2 BCD switching of inputs projection - Ext 1, 2
- control see table
 - after this choice the setting for „EXT.2“ is automatically disabled
- SWIT. 3 BCD switching of inputs projection - Ext 1, 2
- control see table
 - after this choice the setting for „EXT.2“ and „EXT. 3“ is automatically disabled
- STORE Activation of recording of measured data into instrument memory (not a standard option)
- DEF EXT. 1 > HOLD
 - DEF EXT. 2 > LOCK
 - DEF EXT. 3 > SWIT. 1

*

Setting procedure is identical for EXT. 2 and EXT. 3

6.1.4b Selection of function "HOLD"

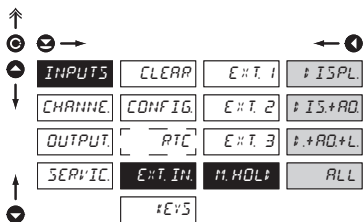

M. HOLD Selection of function "HOLD"

- ↑ ISPL**: "HOLD" locks only the value displayed
- ↑ IS+AO**: "HOLD" locks the value displayed and on AO
- ↑ +AO+L**: "HOLD" locks the value displayed, on AO and limit evaluation
- ALL**: "HOLD" locks the entire instrument

6.1.5a Optional accessory functions of the keys

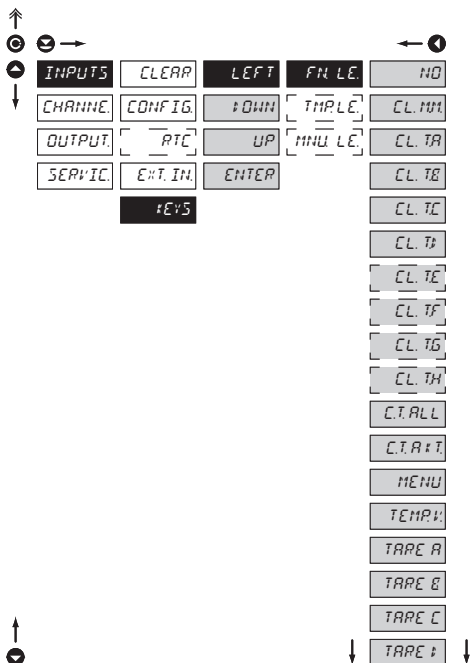

FN. LE. Assigning further functions to instrument keys

- „FN. LE.“ > executive functions
- „TMP. LE.“ > temporary projection of selected values
- „MNU. LE.“ > direct access into menu on selected item

- NO**: Key has no further function
- CL. MIN**: Resetting min/max value
- CL. T->**: Clear tare > by individual inputs
- CL. ALL**: Clear tare on all channels
- CL. ACT.**: Clear tare on current input
- MENU**: Direct access into menu on selected item
- after confirmation of this selection the "MNU. LE." item is displayed on superior menu level, where required selection is performed
- TEMP. V.**: Temporary projection of selected values
- after confirmation of this selection the item "TMP. LE." is displayed on superior menu level, where required selection is performed

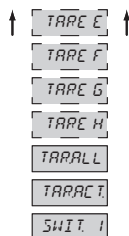

TARE -	Tare activation > by individual inputs
TAPALL	Tare activation on all channels
TAPACT	Tare activation on current input
SHIT 1	Gradual switching of inputs projection

6.1.5b Optional accessory functions of the keys - Temporary projection

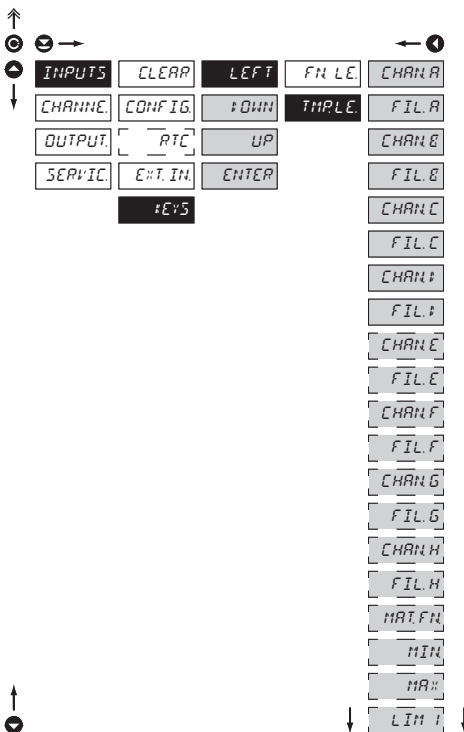

TMP. LE. Temporary projection of selected item

- "Temporary" projection of selected value is displayed for the time of keystroke
- "Temporary" projection may be switched to permanent by pressing + "Selected key", this holds until the stroke of any key

CHAN -	Temporary projection of value input/channel
FIL -	Temporary projection of value input/channel after digital filter processing
MAT.FN	Temporary projection of value "Mathematic function"
MIN	Temporary projection of value "Min. value"
MA::	Temporary projection of value "Max. value"
LIM -	Temporary projection of value "Limits"

- selection from "Temporary" projection of filtered input A, B, C, D, E, F, G, H

- selection from "Temporary" projection of input A, B, C, D, E, F, G, H

- selection from "Temporary" projection of Limits 1, 2, 3, 4, 5, 6, 7, 8

!
Setting is identical for LEFT, DOWN, UP and ENTER

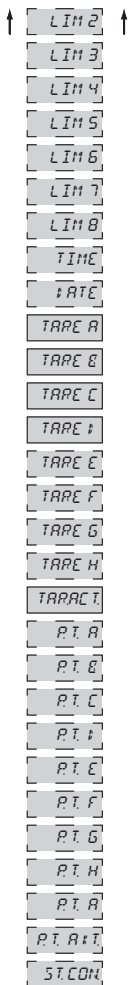

- LIM -** Temporary projection of value "Limits"
- selection from "Temporary" projection Limits 1, 2, 3, 4, 5, 6, 7, 8
- TIME** Temporary projection of "TIME" value
- DATE** Temporary projection of "DATE" value
- TARE -** Temporary projection of "TARE" value
- selection from "Temporary" projection Tare fir input A, B, C, D, E, F, G, H
- TARRACT** Temporary projection of value "TARE"
- "Temporary" projection of Tare for currently selected type
- P.TARRA** Temporary projection of value "P. TAR. A"
- selection from "Temporary" projection of "Fixed tare" for inp. A, B, C, D, E, F, G, H
- P.T.ACT** Temporary projection of value "P. T. ACT."
- "Temporary" projection of "Fixed tare" for currently selected input
- ST.CON** Temporary projection of "CJC" value



Setting is identical for LEFT, DOWN, UP and ENTER



Preset values of the control keys **DEF**:

LEFT	Show Tare
UP	Show Max. value
DOWN	Show Min. value
ENTER	w/o functione

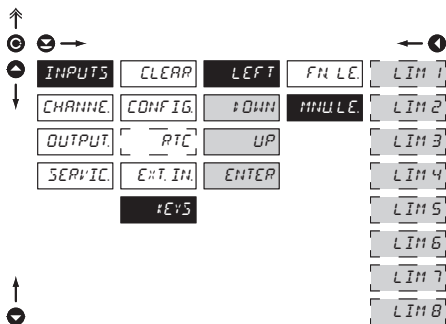
6.1.5c Optional accessory functions of the keys - Direct access to item

MNU LE Assigning access to selected menu item

- LIM 1** Direct access to item "LIM 1"
- LIM 2** Direct access to item "LIM 2"
- LIM 3** Direct access to item "LIM 3"
- LIM 4** Direct access to item "LIM 4"
- LIM 5** Direct access to item "LIM 5"
- LIM 6** Direct access to item "LIM 6"
- LIM 7** Direct access to item "LIM 7"
- LIM 8** Direct access to item "LIM 8"

! Setting is identical for LEFT, DOWN, UP and ENTER

6.2.1b Setting fixed tare

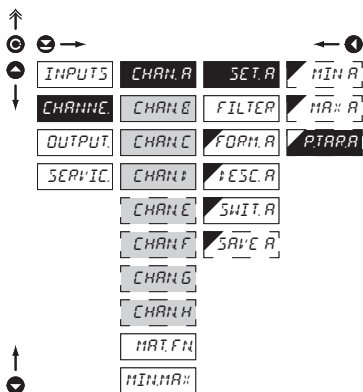
DC **PM** **DU** **OHM**



P.TAR.A Setting "Fixed tare" value

- setting is designed for the event when it is necessary to firmly shift the beginning of the range by known size
- when setting (P.TAR.A > 0) display shows "T" symbol
- range of the setting is 0...9999
- **DEF** = 0



Setting is identical for input B, C, D, E, F, G, H

6.2.1c Digital filters

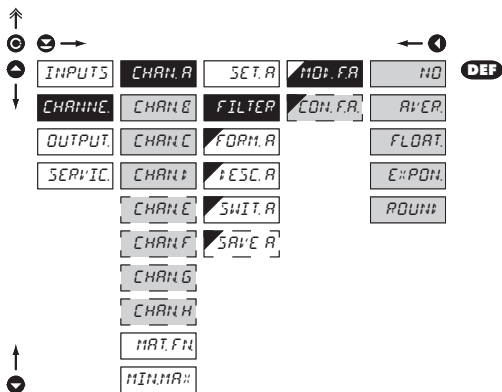
MOD.FA Selection of digital filters

- at times it is useful for better user projection of data on display to modify it mathematically and properly, wherefore the following filters may be used:

NO Filters are off

AVER Measured data average

- arithmetic average from given number („CON.F.A.“) of measured values
- range 2...100

FLOAT Selection of floating filter

- floating arithmetic average from given number („CON.F.A.“) of measured data and updates with each measured value
- range 2...30

EXPON Selection of exponential filter

- integration filter of first prvnho grade with time constant („CON.F.A.“) measurement
- range 2...100

ROUND Measured value rounding

- is entered by any number, which determines the projection step (e.g. "CON.F.A."=2,5 > display 0, 2.5, 5,...)

CON.F.A. Setting constants

- this menu item is always displayed after selection of particular type of filter
- **DEF** = 2



Setting is identical for input B, C, D, E, F, G, H

6.2.1d Projection format - positioning of decimal point

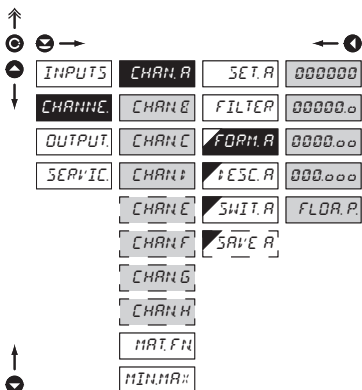

FORM.A Selection of decimal point

- the instrument allows for classic projection of a number with positioning of the DP as well as projection with floating DP, allowing to display a number in its most exact form „FLOAT.P.“

000000 Setting DP - XXXX.

00000.0 Setting DP - XXX.x

DEF

0000.00 Setting DP - XX.xx

000.0000 Setting DP - X.xxx

FLOA.P. Floating DP

! Setting is identical for input B, C, D, E, F, G, H

6.2.1e Projection of description - the measuring units

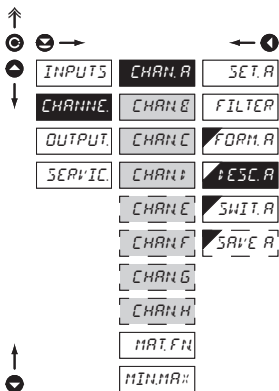

DESC.A Setting projection of description for "Channel A"

- projection of measured data may be extended (at the expense of the number of displayed places) by two characters for description
- description is set by shifted ASCII code, when two first places show the set description and two last characters their code in period 0...95
- description is cancelled by code 00
- **RTD** **T/C** **DEF** = °C
- **DC** **PM** **DU** **OHM** **DEF** = none

! Table of signs on page 89

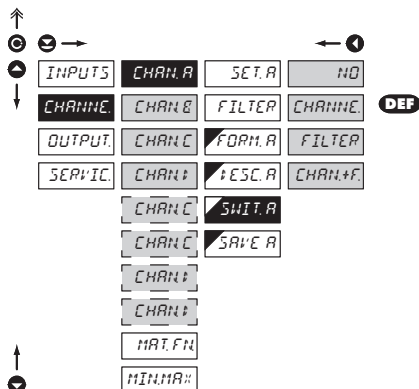
6.2.1f Selection of channel projection upon switching

SWITCH.A Selection of channel projection upon switching

- setting in this item allows the user to choose individual measuring channels, which will be projected upon channel switching through function „SWITCH. A“

- NO Projection prohibited
- CHANNEL "Channel A" will be projected
- FILTER "Channel A" will be projected after digital filter modification
- CHAN.+F. "Chanel A" will be projected and subsequently also "Channel A" after digital filter modification

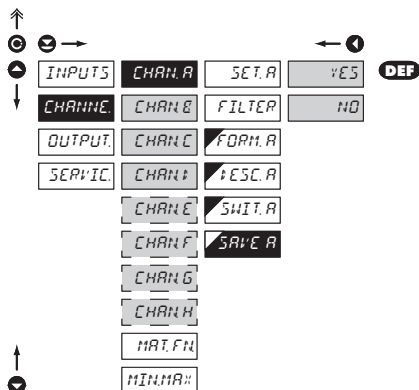

Setting is identical for input B, C, D, E, F, G, H

6.2.1g Selection of storing data into instrument memory

SAVE.A Selection of storing data into instrument memory

- by selection in this item you allow to register values into instrument memory
 - another setting in item "OUTPUT. > MEMORY" (not in standard experiment)

- YES Measured data are stored in the memory
- NO Measured data are not stored



Setting is identical for input B, C, D, E, F, G, H

6.2.2a Mathematic function - input selection

INPUTS	CHAN.A	INP.M	NO
CHANNE	CHAN.B	MAT.F	FIL.A
OUTPUT	CHAN.C	CON.A	FIL.B
SEPV:IC	CHAN.D	CON.B	FIL.C
	CHAN.E	CON.C	FIL.D
	CHAN.F	CON.D	FIL.E
	CHAN.G	CON.E	FIL.F
	CHAN.H	CON.F	FIL.G
MAT.FN	CON.G	FIL.H	
MIN:MA::	CON.H	ALL.F	
	CON.I		
	CON.J		
	FORM.M		
	ESC.M		
	SWIT.M		
	SAVE.M		

DEF

INP.M. Selection of input for calculation of mat. function

- selection of value from which the mathematic function will be calculated

- NO** Mathematic functions are off
- FIL.A** From "input/channel A" after digital filter modification
- FIL.B** From "input/channel B" after digital filter modification
- FIL.C** From "input/channel C" after digital filter modification
- FIL.D** From "input/channel D" after digital filter modification
- FIL.E** From "input/channel E" after digital filter modification
- FIL.F** From "input/channel F" after digital filter modification
- FIL.G** From "input/channel G" after digital filter modification
- FIL.H** From "input/channel H" after digital filter modification
- ALL.F** From all inputs/channels after digital filter modification

6.2.2b Mathematic functions

↑
 Ⓞ →
 Ⓢ →
 ↓

INPUTS	CHAN. A	INP. M.	MULTIN	DEF
CHANNE	CHAN. B	MATH. F.	I·MUL	
OUTPUT	CHAN. C	CON. A	LOGARR	
SERVIC.	CHAN. D	CON. B	E:POW	
	CHAN. E	CON. C	POWER	
	CHAN. F	CON. D	ROOT	
	CHAN. G	CON. E	SIN #	
	CHAN. H	CON. F		
MAT.FM	CON. G			
MIN.MA#	CON. H	SUMA	DEF	
		CON. I	I·I·I·E	
		CON. J	QUA:ER	
		FORM.M.		
		ESC.M.		
		SWIT.M.		
		SAVE.M.		

↑

MATH. F. Selection of mathematic functions

In selecting „FIL. -“ in item „INP. M.“

MULTIN Polynome

$$Ax^2 + Bx^3 + Cx^4 + Dx^5 + Ex + F$$

I·MUL 1/x

$$\frac{A}{x^3} + \frac{B}{x^4} + \frac{C}{x^3} + \frac{D}{x^2} + \frac{E}{x} + F$$

LOGARR Logarithm

$$A \times \ln\left(\frac{Bx+C}{Dx+E}\right) + F$$

E:POW Exponential

$$A \times e^{\left(\frac{Bx+C}{Dx+E}\right)} + F$$

POWER Power

$$A \times (Bx+C)^{(Dx+E)} + F$$

ROOT Root

$$A \times \sqrt{\frac{Bx+C}{Dx+E}} + F$$

SIN # Sin x

$$A \sin^3 x + B \sin^4 x + C \sin^3 x + D \sin^2 x + E \sin x + F$$

In selecting „ALL. F.“ in item „INP. M.“

SUMA Total of values from channels (inputs)

$$(A \times KA + B \times KB + C \times KC + D \times KD + G \times KE + H \times KF + I \times KG + J \times KH) \times E + F$$

I·I·I·E Channels (inputs) values division

$$(A \times KA + C \times KC + G \times KE + J \times KJ) / (B \times KB + D \times KD + H \times KF + J \times KH) \times E + F$$

QUA:ER Product of channels (inputs) values

$$(A \times KA^2 + B \times KB^2 + C \times KC^2 + D \times KD^2 + G \times KE^2 + H \times KF^2 + I \times KG^2 + J \times KH^2) \times E + F$$

CON. - Setting constants for calculation of mat. fce.

- this menu is displayed only after selection of given mathematic function

6.2.2c Mathematic functions - decimal point

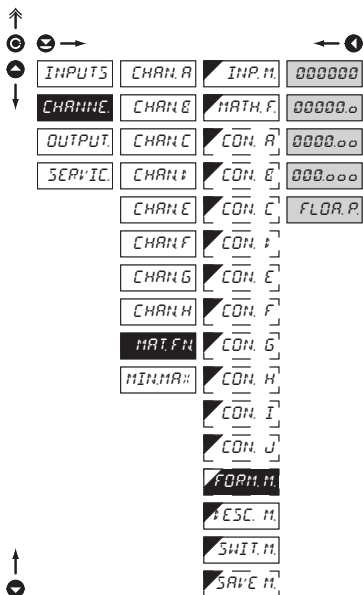

FORM.H. Selection of decimal point

- the instrument allows for classic projection of a number with positioning of the DP as well as projection with floating DP, allowing to display a number in its most exact form „FLOA.P.“

000000. Setting DP - XXXX.

00000.0 Setting DP - XXX.x

0000.00 Setting DP - XX.xx

000.000 Setting DP - X.xxx

FLOA.P. Floating DP

DEF

6.2.2d Mathematic functions - measuring units

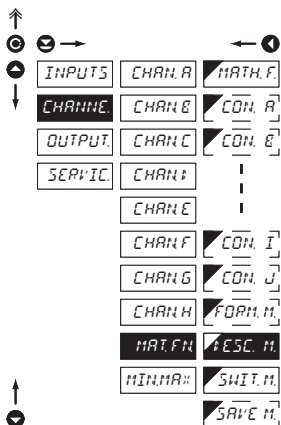

P.ESC.M. Setting projection of description for "MAT.FN"

- projection of measured data may be extended (at the expense of the number of displayed places) by two characters for description
- description is set by shifted ASCII code, when two first places show the set description and two last characters their code in period 0...95
- description is cancelled by code 00
- **DEF** = no description

!

Table of signs on page 89

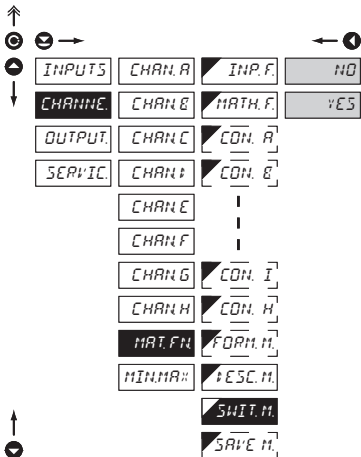
6.2.2e Mathematics - selection of channel projection upon switching

SWIT.M. Selection of channel projection upon switching

- settin in this item allows the user to chose individual measuring channels, which will get projected upon switching function channels „SWITCH. A“

YES Projection admitted

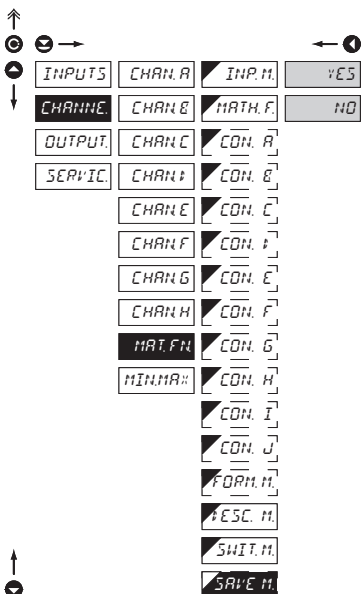
NO Projection denied

6.2.2f Mathematics - selection of storing data into instrument memory

SAVE.M. Selection of storing data into instrument memory

- by selection in this item you allow to register values into instrument memory
 - another settin in item "OUTPUT. > MEMORY" (not in standard experiment)

YES Measured data are stored in the memory

NO Measured data are not stored

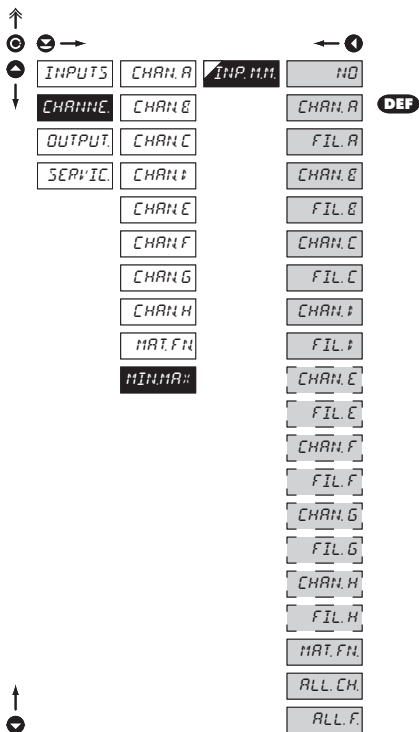
6.2.3 Selection of evaluation of min/max value



INP.MX Selection of evaluation of min/max value

- selection of value from which the min/max value will be calculated

NO Evaluation of min/max value is off

CHAN. - From selected input

- selection from inputs 1, 2, 3, 4, 5, 6, 7, 8

FIL. - From selected input after digital filter modification

- selection from inputs 1, 2, 3, 4, 5, 6, 7, 8

MAT.FN. From "Mathematic functions

ALL.CH. From all channels

ALL.F. From all inputs after digital filter modification

6.3 Setting „PROFI“ - OUTPUTS

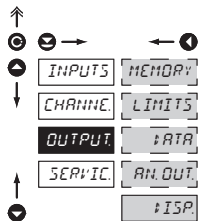

In this menu it is possible to set parameters of the instrument output signals

- MEMORY** Setting data logging into memory
- LIMITS** Setting type and parameters of limits
- I:RTR** Setting type and parameters of data output
- AN. OUT.** Setting type and parameters of analog output
- I:ISP** Setting display projection and brightness

6.3.1a Selection of mode of data logging into instrument memory

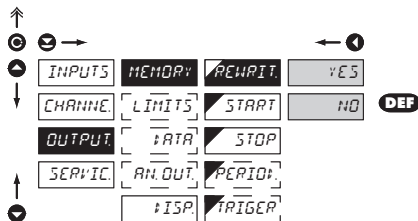

REWRIT. Selection of the mode of data logging

- selection of the mode in the event of full instrument memory

- NO** Rewriting values prohibited
- YES** Rewriting values permitted, the oldest get rewritten by the latest

6.3.1b Setting data logging into instrument memory - RTC

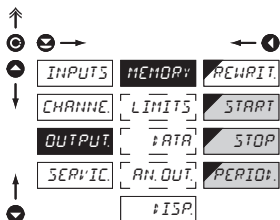

- START** Start of data logging into instrument memory
 - time format HH.MM.SS
- STOP** Stop data logging into instrument memory
 - time format HH.MM.SS
- PERIOD** Period of data logging into instrument memory
 - determines the period in which values will be logged in an interval delimited by the time set under items START and STOP
 - time format HH.MM.SS
 - records are made on a daily basis in selected interval and period
 - item not displayed if "STORE" is selected in menu (Input > EXT. IN.)

6.3.1c Setting data logging into instrument memory - FAST

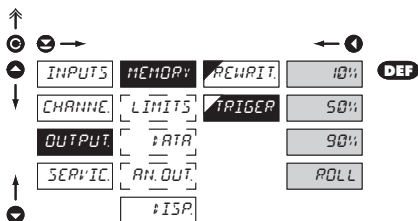

- TRIGGER** Setting logging data into inst. memory
 - logging data into inst. memory is governed by the following selection, which determines how many percent of the memory is reserved for data logging prior to initiation of trigger impulses
 - initiation is on ext. input or control key
- | | |
|-----|---|
| 10% | Reser. of 10 % memory prior init. of data logging |
| 50% | Reser. of 50 % memory prior init. of data logging |
| 90% | Reser. of 90 % memory prior init. of data logging |
| PDL | After initiation of data logging the memory is cyclically transcribed |

6.3.2a Selection of input for limits evaluation

↑

⊙ ☹ →

⬆

INPUTS	MEMORY	LIM 1	INP. L. 1	NO
CHANNE	LIMITS	LIM 2	NO: L. 1	CHAN. R
OUTPUT	FATR	LIM 3	TYP. L. 1	FIL. R
SERVIC	AN. OUT.	LIM 4	LIM. L. 1	CHAN. B
	#ISP.	LIM 5	HYS. L. 1	FIL. B
		LIM 6	ON. L. 1	CHAN. C
		LIM 7	OFF. L. 1	FIL. C
		LIM 8	PER. L. 1	CHAN. F
			TIM. L. 1	FIL. F
				CHAN. E
				FIL. E
				CHAN. G
				FIL. G
				CHAN. H
				FIL. H
				MAT. FN.
				MIN
				MAX
				ALL. CH.
				ALL. F.

DEF

↑

⊙

INP. L. 1 Selection evaluation of limits

- selection of value from which the limit will be evaluated

NO Limit evaluation is off

CHAN. - From selected input

- selection from inputs 1, 2, 3, 4, 5, 6, 7, 8

FIL. - From selected input after digital filter modification

- selection from inputs 1, 2, 3, 4, 5, 6, 7, 8

MAT. FN. Limit evaluation from "Mathematic functions"

MIN Limit evaluation from "Min.value"

MAX Limit evaluation from "Max.value"

ALL. CH. From all inputs

ALL. F. From all inputs after digital filter modification



Setting is identical for LIM 2 ... LIM 8

6.3.2b Selection of type of limit

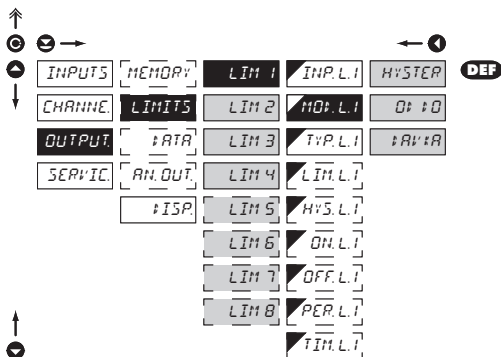

MOD.L.1 Selection the type of limit

HYS.TER

Limit is in mode "Limit, hysteresis, delay"

- for this mode the parameters of "LIM. L." are set, at which the limit will shall react, "HYS. L." the hysteresis range around the limit (LIM ±1/2 HYS) and time "TIM. L." determining the delay of relay switch-on

FRON

Frame limit

- for this mode the parameters are set for interval "ON. L." the relay switch-on and "OFF. L." the relay switch-off

I.OSING

Dose limit (periodic)

- for this mode the parameters are set for "PER. L." determining the limit value as well as its multiples at which the output is active and "TIM. L." indicating the time during which is the output active



Setting is identical for LIM 2 ... LIM 8

6.3.2c Selection of type of output

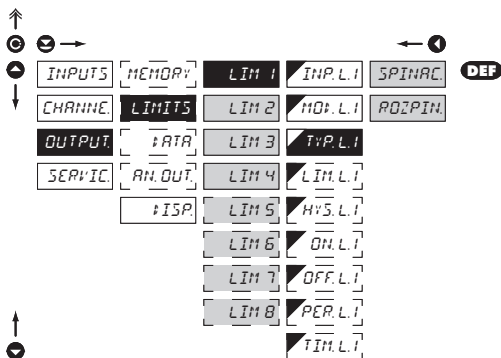

T.Y.P.L.1

Selection of type of output

CLOSE

Output switches on when condition is met

OPEN

Output switches off when condition is met

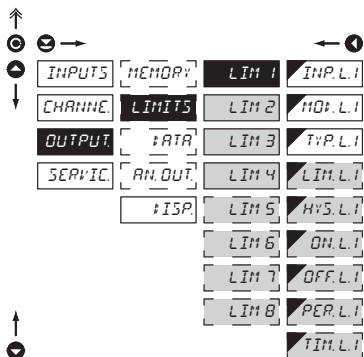

Setting is identical for LIM 2 ... LIM 8

6.3.2d Setting values for limits evaluation

LIM. L. 1 Setting limit for switch-on

- for type "HYSTER"

HYS. L. 1 Setting hysteresis

- for type "HYSTER"

- indicates the range around the limit (in both directions, LIM. $\pm 1/2$ HYS.)

ON. L. 1 Setting the outset of the interval of limit switch-on

- for type "FROM"

OFF. L. 1 Setting the end of the interval of limit switch-on

- for type "FROM"

PER. L. 1 Setting the period of limit switch-on

- for type "DOSE"

TIM. L. 1 Setting the time switch-on of the limit

- for type "HYSTER" and "DOSE"



Setting is identical for LIM 2 ... LIM 8

6.3.3a Selection of data output baud rate

The screenshot shows the main menu with the following items:

- INPUTS
- CHANNEL
- OUTPUT
- SERVIC
- MEMORY
- LIMITS
- AN. OUT.
- ISP
- BAUD
- A:R
- A:R.P.E.
- PROT.

The BAUD menu is expanded to show the following options:

- 600
- 1200
- 2400
- 4800
- 9600 (DEF)
- 19200
- 38400
- 57600
- 115200
- 230400

BAUD	Setting of data output baud rate
600	Rate - 600 Baud
1200	Rate - 1 200 Baud
2400	Rate - 2 400 Baud
4800	Rate - 4 800 Baud
9600	Rate - 9 600 Baud
19200	Rate - 19 200 Baud
38400	Rate - 38 400 Baud
57600	Rate - 57 600 Baud
115200	Rate - 115 200 Baud
230400	Rate - 230 400 Baud

6.3.3b Setting instrument address

The screenshot shows the main menu with the following items:

- INPUTS
- CHANNEL
- OUTPUT
- SERVIC
- MEMORY
- LIMITS
- AN. OUT.
- ISP
- A:R
- A:R.P.E.
- PROT.

The A:R.P.E. menu is expanded to show the following options:

- 1

A:R	Setting instrument address
-	- setting in range 0...31
DEF	= 00

A:R.P.E.	Setting instrument address - MODBUS
-	- setting in range 1...247
DEF	= 1

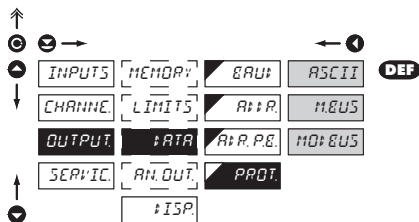
6.3.3c Selection of data output protocol

PROT. Selection of the type of analog output

ASCII Data protocol ASCII

MEUS Data protocol DIN MessBus

MD+EUS Data protocol MODBUS-RTU

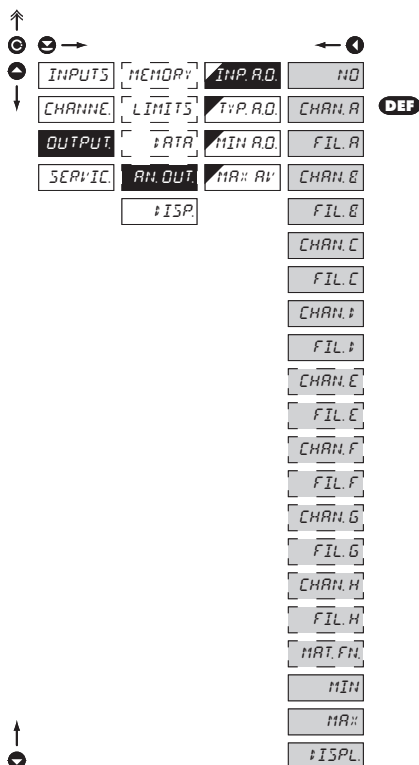
- option is available only for RS 485

6.3.4a Selection of input for analog output

INP. AD. Selection evaluation analog output

- selection of value from which the analog output will be evaluated

NO AO evaluation is off

CHAN. - From selected input

- selection from inputs 1, 2, 3, 4, 5, 6, 7, 8

FIL. - From selected input after digital filter modification

- selection from inputs 1, 2, 3, 4, 5, 6, 7, 8

MAT. FN. AO evaluation from "Math.functions"

MIN AO evaluation from "Min.value"

MA:: AO evaluation from "Max.value"

:ISP.L From currently displayed value

6.3.4b Selection of the type of analog output

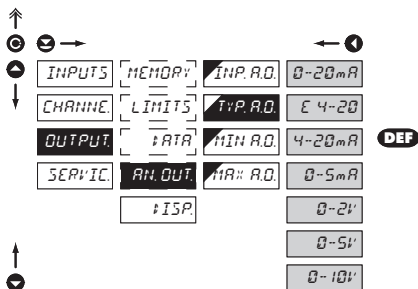

TV.P. R.D. Selection of the type of analog output

0-20mA Type - 0...20 mA

ε 4-20 Type - 4...20 mA

- with indication of error statement (< 3,0 mA)

4-20mA Type - 4...20 mA

0-5mA Type - 0...5 mA

0-2V Type - 0...2 V

0-5V Type - 0...5 V

0-10V Type - 0...10 V

6.3.4c Setting the analog output range

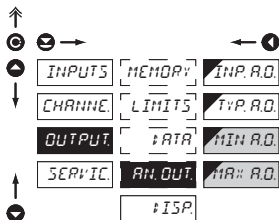

AN. OUT. Setting the analog output range

- analog output is isolated and its value corresponds with displayed data. It is fully programmable, i.e. it allows to assign the AO limit points to two arbitrary points of the entire measuring range

MIN. R.D. Assigning the display value to the beginning of the AO range

- range of the setting is -999...9999

- **DEF** = 0

MA: R.D. Assigning the display value to the end of the AO range

- range of the setting is -999...9999

- **DEF** = 100

6.3.5a Selection of input for display projection

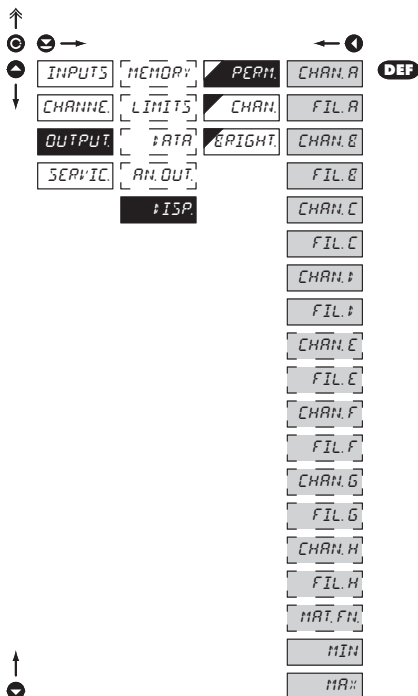
PERM Selection display projection

- selection of value which will be shown on the instrument display

CHAN.A	Projection of values from "Channel A"
FIL.A	From "Channel A" after digital filters processing
CHAN.B	Projection of values from "Channel B"
FIL.B	From "Channel B" after digital filters processing
CHAN.C	Projection of values from "Channel C"
FIL.C	From "Channel C" after digital filters processing
CHAN.D	Projection of values from "Channel D"
FIL.D	From "Channel D" after digital filters processing
CHAN.E	Projection of values from "Channel E"
FIL.E	From "Channel E" after digital filters processing
CHAN.F	Projection of values from "Channel F"
FIL.F	From "Channel F" after digital filters processing
CHAN.G	Projection of values from "Channel G"
FIL.G	From "Channel G" after digital filters processing
CHAN.H	Projection of values from "Channel H"
FIL.H	From "Channel H" after digital filters processing
MAT.FN	Projection of values from "Math.functions"
MIN	Projection of values from "Min.value"
MAX	Projection of values from "Max.value"

6.3.5b Selection of signalization of measuring inputs on display

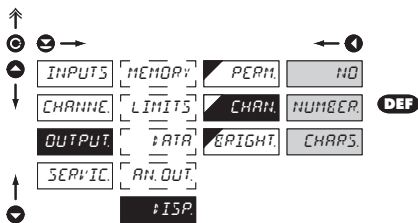

CHAR. Selection of inputs signalization

- NO** Display is off
- NUMBER.** Numeric description of inputs
 - inputs are marked 1, 2, 3, 4, 5, 6, 7, 8
- CHARS.** Alphabetical description of inputs
 - inputs are marked A, B, C, D, E, F, G, H

6.3.5c Selection of display brightness

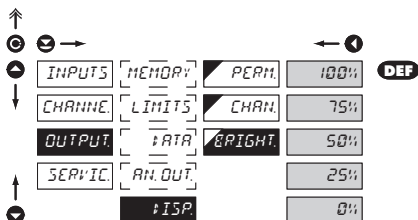

BRIGHT Selection of display brightness

- by selecting display brightness we may appropriately react to light conditions in place of instrument location
- 0%** Display is off
- after keystroke display turns on for 10 s
- 25%** Display brightness - 25%
- 50%** Display brightness - 50%
- 75%** Display brightness - 75%
- 100%** Display brightness - 100%

6.4 Setting "PROFI" - SERVICE

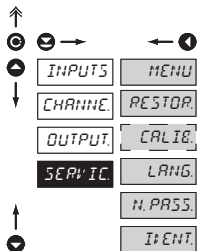

The instrument service functions are set in this menu

MENU	Selection of menu type LIGHT/PROFI
RESTOR.	Restore instrument manufacture setting and calibration
CALIB.	Input range calibration for „DU“ version
LANG.	Language version of instrument menu
N.PASS.	Setting new access password
IDENT.	Instrument identification

6.4.1 Selection of type of programming menu

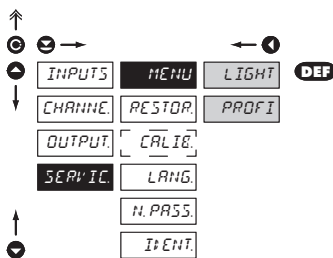

MENU Selection of menu type - LIGHT/PROFI

- enables setting the menu complexity according to user needs and skills

LIGHT Active LIGHT menu

- simple programming menu, contains only items necessary for configuration and instrument setting
- linear menu > items one after another

PROFI Active PROF I menu

- complete programming menu for expert users
- tree menu



Change of setting is valid upon next access into menu

6.4.2 Restoration of manufacture setting

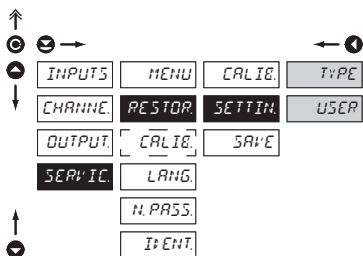
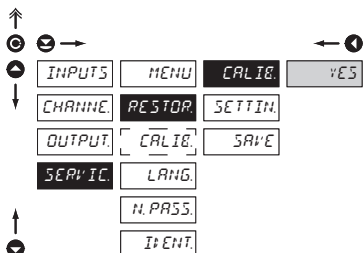

RESTOR. Restoration of manufacture setting

- in the event of error setting or calibration, manufacture setting may be restored.

CALIB. Restoration of manufacture calibration of the instrument

- prior executing the changes you will be asked to confirm your selection „YES“

SETTIN. Restoration of instrument manufacture setting

TYPE Restoration of instrument manufacture setting

- generating the manufacture setting for currently selected type of instrument (items marked DEF)

USER Restoration of instrument user setting

- generating the instrument user setting, i.e. setting stored under SERVIC./RESTOR./SAVE

SAVE Save instrument user setting

- storing the user setting allows the operator to restore it in future if needed

Jobs performed	Restore	
	Calibration	Setting
cancel USER menu rights	✓	✓
deletes table of items order in USER - LIGHT menu	✓	✓
adds items from manufacture to LIGHT menu	✓	✓
deletes data stored in FLASH	✓	✓
cancel or linearization tables	✓	✓
clears tare	✓	✓
clears conduct resistances	✓	✓
restore manufacture calibration	✓	x
restore manufacture setting	x	✓

!
After restoration the instrument switches off for couple seconds

6.4.3 Calibration - Input range

DU

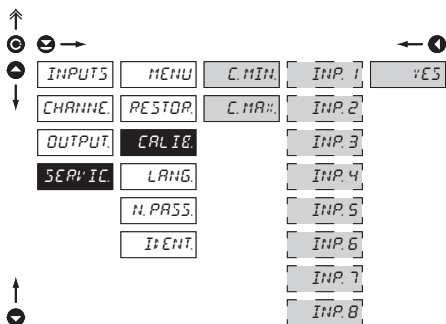
**CALIB.** Input range calibration

- the inputs for calibration always include only active inputs, i.e. those that are set for "MOD > DU".
- after projection of "C. MIN." and selection of relevant input move the potentiometer runner into required minimum position and confirm by „Enter“, calibration is confirmed by „YES“ notice
- after projection of "C. MAX." and selection of given input move the potentiometer into required maximum position and confirm by „Enter“, calibration is confirmed by „YES“

6.4.4 Selection of instrument menu language version

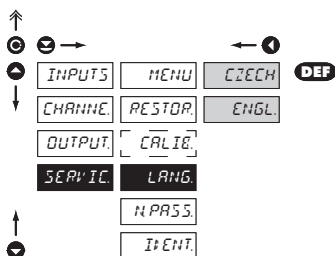
**LANG.** Selection of instrument menu language version

- | | |
|--------------|-------------------------------|
| CZECH | Instrument menu is in Czech |
| ENGL. | Instrument menu is in English |

6.4.5 Setting new access password

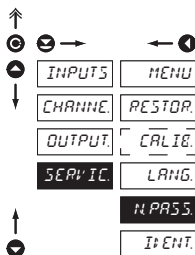

N. PASS. Setting new password for access to LIGHT and PROFi menu

- this selection enables changing number code that blocks the access into LIGHT and PROFi Menu.
- range of the number code is 0...9999
- universal password in the event of loss is „8177“

6.4.6 Instrument identification

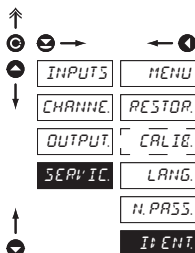

I+ENT. Projection of instrument SW version

- display shows type identification of the instrument, SW number, SW version and current input setting (Mode)
- if the SW version reads a letter on first position, it is a customer SW

7.0 Setting items into "USER" menu

- **USER** menu is designed for users who need to change only several items of the setting without the option to change the primary instrument setting (e.g. repeated change of limit setting)
- there are no items from manufacture permitted in **USER** menu
- on items indicated by inverse triangle  L i
- setting may be performed in **LIGHT** or **PROFI** menu, with the **USER** menu then overtaking the given menu structure



- For user operation
- Menu items are set by the user (Profi/Light) as per request
- Access is not password protected

Setting

flashing legend - current setting is displayed



NO

item will not be displayed in USER menu

YES

item will be displayed in USER menu with editing option

SHOW

item will be solely displayed in USER menu

Setting sequence of items in "USER" menu

In compiling USER menu from active LIGHT menu the items (max. 10) may be assigned a sequence, in which they will be projected in the menu

setting projection sequence



Example:

Into USER menu were selected these items

(keys \leftarrow + \rightarrow) > CL. TAR., LIM 1, LIM 2, LIM 3, for which we have preset this sequence (keys \leftarrow + \rightarrow):

CL. TAR.	5
LIM 1	0 (sequence not determined)
LIM 2	2
LIM 3	1

Upon entering USER menu

(key \rightarrow) items will be projected in the following sequence: LIM 3 > LIM 2 > CL.TAR. > LIM 1

Instrument with input for temperature measurement with thermocouple allows to set two types of measurement of cold junction.

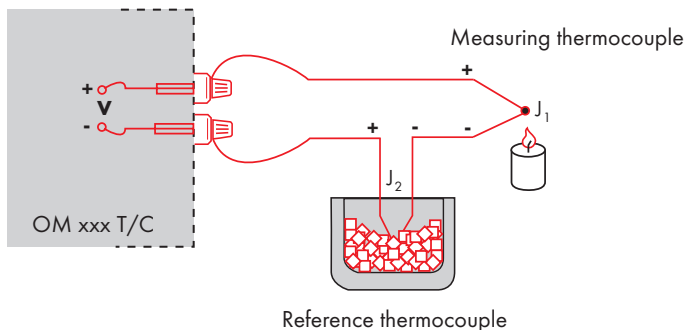

WITH REFERENCE THERMOCOUPLE

- a reference thermocouple may be located in the same place as the measuring instrument or in place with stable temperature/compensation box
- when measuring with reference thermocouple set *CONNECT* in the instrument menu to *INT2TC* or *E::T2TC*
- when using a thermostat (a compensation box or environment with constant temperature) set in the instrument menu *CJCTEM* its temperature (applies for setting *CONNECT* to *E::T2TC*)
- if the reference thermocouple is located in the same environment as the measuring instrument then set in the instrument menu *CONNECT* to *INT2TC*. Based on this selection the measurement of the ambient temperature is performed by a sensor located in the instrument terminal board.

WITHOUT REFERENCE THERMOCOUPLE

- inaccuracy originating from the creation of dissimilar thermocouples on the transition point terminal/conductor of the thermocouple is not compensated for in the instrument
- when measuring without reference thermocouple set *CONNECT* in the instrument menu to *INT1TC* or *E::T1TC*
- when measuring temperature without reference thermocouple the error in measured data may be as much as 10°C (applies for setting *CONNECT* to *E::T1TC*)



The instruments communicate via serial line RS232 or RS485. For communication they use the ASCII protocol. Communication runs in the following format:

ASCII: 8 bit, no parity, one stop bit
 DIN MessBus: 7 bit, even parity, one stop bit

The transfer rate is adjustable in the instrument menu. The instrument address is set in the instrument menu in the range of 0 ÷ 31. The manufacture setting always presets the ASCII protocol, rate of 9600 Baud, address 00. The type of line used - RS232 / RS485 - is determined by an output board automatically identified by the instrument.

The commands are described in specifications you can find at [na www.orbit.merret.cz/rs](http://na.www.orbit.merret.cz/rs) or in the OM Link program.

DETAILED DESCRIPTION OF COMMUNICATION VIA SERIAL LINE

Event	Type	Protocol	Transmitted data																	
Data solicitation (PC)	232	ASCII	#	A	A	<CR>														
		MessBus	No - data is transmitted permanently																	
	485	ASCII	#	A	A	<CR>														
		MessBus	<SADR>	<ENQ>																
Data transmission (instrument)	232	ASCII	>	D	(D)	(D)	(D)	(D)	(D)	(D)	(D)	(D)	(D)	(D)	(D)	(D)	(D)	<CR>		
		MessBus	<SADR>	D	(D)	(D)	(D)	(D)	(D)	(D)	(D)	(D)	(D)	(D)	(D)	(D)	(D)	(D)	<ETX>	<BCC>
	485	ASCII	>	D	(D)	(D)	(D)	(D)	(D)	(D)	(D)	(D)	(D)	(D)	(D)	(D)	(D)	(D)	<CR>	
		MessBus	<SADR>	D	(D)	(D)	(D)	(D)	(D)	(D)	(D)	(D)	(D)	(D)	(D)	(D)	(D)	(D)	<ETX>	<BCC>
Confirmation of data acceptance (PC) - OK	485	MessBus	<DLE>	1																
Confirmation of data acceptance (PC) - Bad			<NAK>																	
Sending address (PC) prior command			<EADR>	<ENQ>																
Confirmation of address (instrument)			<SADR>	<ENQ>																
Command transmission (PC)	232	ASCII	#	A	A	N	P	(D)	(D)	(D)	(D)	(D)	(D)	(D)	(D)	(D)	(D)	<CR>		
		MessBus	<STX>	\$	N	P	(D)	(D)	(D)	(D)	(D)	(D)	(D)	(D)	(D)	(D)	(D)	<ETX>	<BCC>	
	485	ASCII	#	A	A	N	P	(D)	(D)	(D)	(D)	(D)	(D)	(D)	(D)	(D)	(D)	<CR>		
		MessBus	<SADR>	\$	N	P	(D)	(D)	(D)	(D)	(D)	(D)	(D)	(D)	(D)	(D)	(D)	<ETX>	<BCC>	
Command confirmation (instrument)	232	ASCII	OK	!	A	A	<CR>													
			Bad	?	A	A	<CR>													
		MessBus	No - data is transmitted permanently																	
	485	ASCII	OK	!	A	A	<CR>													
			Bad	?	A	A	<CR>													
		MessBus	OK	<DLE>	1															
			Bad	<NAK>																
Command confirmation (inst.) - OK	485	MessBus	!	A	A	<CR>														
?			A	A	<CR>															
Instrument identification			#	A	A	1Y	<CR>													
HW identification			#	A	A	1Z	<CR>													
One-time transmission			#	A	A	7X	<CR>													
Repeated transmission			#	A	A	8X	<CR>													

LEGEND

#	35	23 _H	Command beginning
A	A	0...31	Two characters of instrument address (sent in ASCII - tens and units, e.g. "01", "99" universal
<CR>	13	0D _H	Carriage return
<SP>	32	20 _H	Space
N, P			Number and command - command code
D			Data - usually characters "0"... "9", "-", ".", ";", (D) - dp. and (-) may prolong data
R	30 _H ...3F _H		Relay and tare status
!	33	21 _H	Positive confirmation of command (ok)
?	63	3F _H	Negative confirmation of command (point)
>	62	3E _H	Beginning of transmitted data
<STX>	2	02 _H	Beginning of text
<ETX>	3	03 _H	End of text
<SADR>	address +60 _H		Prompt to send from address
<EADR>	address +40 _H		Prompt to accept command at address
<ENQ>	5	05 _H	Terminate address
<DLE>	16 49	10 _H 31 _H	Confirm correct statement
<NAK>	21	15 _H	Confirm error statement
<BCC>			Check sum -XOR

RELAY, TARE

Sign	Relay 1	Relay 2	Tare	Change relay 3/4
P	0	0	0	0
Q	1	0	0	0
R	0	1	0	0
S	1	1	0	0
T	0	0	1	0
U	1	0	1	0
V	0	1	1	0
W	1	1	1	0
p	0	0	0	1
q	1	0	0	1
r	0	1	0	1
s	1	1	0	1
t	0	0	1	1
u	1	0	1	1
v	0	1	1	1
w	1	1	1	1

Relay status is generated by command #AA6X <CR>.

The instrument immediately returns the value in the format >HH <CR>, where HH is value in HEX format and range 00_H...FF_H. The lowest bit stands for „Relay 1“, the highest for „Relay 8“

ERROR	CAUSE	ELIMINATION
<i>E. P. U_n</i>	Number is too small (large negative) to be displayed	change DP setting, channel constant setting
<i>E. P. O_r</i>	Number is too large to be displayed	change DP setting, channel constant setting
<i>E. T. U_n</i>	Number is outside the table range	increase table values, change input setting (channel constant setting)
<i>E. T. O_r</i>	Number is outside the table range	increase table values, change input setting (channel constant setting)
<i>E. I. U_n</i>	Input quantity is smaller than permitted input quantity range	change input signal value or input (range) setting
<i>E. I. O_r</i>	Input quantity is larger than permitted input quantity range	change input signal value or input (range) setting
<i>E. HW</i>	A part of the instrument does not work properly	send the instrument for repair
<i>E. EE</i>	Data in EEPROM corrupted	perform restoration of manufacture setting, upon repeated error statement send instrument for repair
<i>E. E. A. T. A</i>	Data in EEPROM outside the range	perform restoration of manufacture setting, upon repeated error statement send instrument for repair
<i>E. CLR</i>	Memory was empty (presetting carried out)	upon repeated error statement send instrument for repair, possible failure in calibration

The instrument allows to add two descriptive characters to the classic numeric formats (at the expense of the number of displayed places). The setting is performed by means of a shifted ASCII code. Upon modification the first two places display the entered characters and the last two places the code of the relevant symbol from 0 to 95. Numeric value of given character equals the sum of the numbers on both axes of the table.

Description is cancelled by entering characters with code 00

	0	1	2	3	4	5	6	7		0	1	2	3	4	5	6	7	
0		7	"	#	\$	%	&	'		0	!	"	#	\$	%	&	'	
8	:)	*	+	,	-	.	/		8	()	*	+	,	-	.	/
16	0	1	2	3	4	5	6	7		16	0	1	2	3	4	5	6	7
24	8	9	:	;	<	=	>	?		24	8	9	:	;	<	=	>	?
32	P	R	E	C	T	E	F	G		32	@	A	B	C	D	E	F	G
40	H	I	J	K	L	M	N	O		40	H	I	J	K	L	M	N	O
48	P	Q	R	S	T	U	V	W		48	P	Q	R	S	T	U	V	W
56	X	Y	Z	[\]	^	_		56	X	Y	Z	[\]	^	_
64	`	a	b	c	d	e	f	g		64	`	a	b	c	d	e	f	g
72	h	i	j	k	l	m	n	o		72	h	i	j	k	l	m	n	o
80	p	q	r	s	t	u	v	w		80	p	q	r	s	t	u	v	w
88	X	Y	Z	{		}	~			88	x	y	z	{		}	~	

INPUT

Number:	4/8 inputs	
	- automatic or manual switching	
range is adjustable	±60 mV	>100 MOhm
	±150 mV	>100 MOhm
	±300 mV	>100 MOhm
	±1200 mV	>100 MOhm

DC

Input U
Input U
Input U
Input U

range is adjustable

0/4...20 mA	< 400 mV
±2 V	1 MOhm
±5 V	1 MOhm
±10 V	1 MOhm
±40 V	1 MOhm

PM

Input I
Input U
Input U
Input U
Input U

range is adjustable

0...100 Ohm
0...1 kOhm
0...10 kOhm
0...100 kOhm

OHM

Connection: 2, 3 or 4 wire

Pt xxxxx	-200°...850°C
Pt xxxxx/3910 ppm	-200°...1 100°C
Ni xxxxx	-50°...250°C
Cu/4260 ppm	-50°...200°C
Cu/4280 ppm	-200°...200°C
Type Pt:	EU > 100/500/1 000 Ohm, with 3 850 ppm/°C
	US > 100 Ohm, with 3 920 ppm/°C
	RU > 50/100 Ohm, with 3 910 ppm/°C

RTD

Type Ni:	Ni 1 000/ Ni 10 000 with 5 000/6 180 ppm/°C
Type Cu:	Cu 50/Cu 100 with 4 260/4 280 ppm/°C
Connection:	2, 3 or 4 wire

range is adjustable in configuration menu

Type:	J (Fe-CuNi)	-200°...900°C
	K (NiCr-Ni)	-200°...1 300°C
	T (Cu-CuNi)	-200°...400°C
	E (NiCr-CuNi)	-200°...690°C
	B (PtRh30-PtRh6)	300°...1 820°C
	S (PtRh10-Pt)	-50°...1 760°C
	R (Pt13Rh-Pt)	-50°...1 740°C
	N (Omegalloy)	-200°...1 300°C

T/C

Voltage of lin. pot.	2,5 VDC/6 mA
	min. potentiometer resistance is 500 Ohm

DU**PROJECTION**

Display:	9999, intensive red or green
Measured value	14-segment LED, digit height 14 mm
Description	99, intensive red or green
	14-segment LED, digit height 10 mm
Input number	9, intensive red or green
	7-segment LED, digit height 9 mm
	-999...9999
Projection:	
Decimal point:	adjustable - in menu
Brightness:	adjustable - in menu

INSTRUMENT ACCURACY

TC:	100 ppm/°C	
Accuracy:	±0,1 % of range + 1 digit	RTD, T/C
	±0,15 % of range + 1 digit	
	±0,3 % of range + 1 digit	
Resolution:	0,01°/0,1°/1°	PWR
Rate:	0,1...40 measurements/s**	RTD
Overload capacity:	10x (t < 100 ms), 2x (long-term)	
Linearisation:	by linear interpolation in 254 points	
	- solely via OM Link	
Digital filters:	Averaging, Floating average, Exponential filter, Rounding	
Comp. of conduct:	max. 40 Ohm/100 Ohm	RTD
Comp. of cold junc.:	adjustable	T/C
	0°...99°C or automatic	
Functions:	Tare - display resetting	
	Hold - stop measuring (at contact)	
	Lock - control key locking	
	MM - min/max value	
	Mathematic functions	
OM Link:	company communication interface for setting, operation and update of instrument SW	
Watch-dog:	reset after 400 ms	
Calibration:	at 25°C and 40 % of r.h.	

COMPARATOR

Type:	digital, adjustable in menu
Mode:	Hysteresis, From, Dosing
Limits:	-99999...999999
Hysteresis:	0...999999
Delay:	0...99,9 s
Outputs:	2x relays with switch-on contact (Form A) (230 VAC/30 VDC, 3 A)*
	2x relays with switch-off contact (Form C) (230 VAC/50 VDC, 3 A)*
	2x SSR (250 VAC/ 1 A)*
	2x/4x open collector (30 VDC/100 mA)
	2x bistabil relays (250 VAC/250 VDC, 3 A/0,3 A)*
Relay:	1/8 HP 277 VAC, 1/10 HP 125 V, Pilot Duty D300

* values apply for resistance load

DATA OUTPUTS

Protocols: ASCII, DIN MessBus, MODBUS, PROBUS
 Data format: 8 bit + no parity + 1 stop bit (ASCII)
 7 bit + even parity + 1 stop bit (MessBus)
 Rate: 600...230 400 Baud
 RS 232: isolated, two-way communication
 RS 485: isolated, two-way communication,
 addressing (max. 31 instruments)
 PROFIBUS Data protocol SIEMENS

ANALOGO OUTPUTS

Type: isolated, programmable with resolution of max.10 000 points, analog output corresponds with displayed data, type and range are adjustable
 Non-linearity: 0,2% of range
 TC: 100 ppm/°C
 Rate: response to change of value < 150 ms
 Voltage: 0...2 V/5 V/10 V
 Current: 0...5/20 mA/4...20 mA
 - compensation of conduct to 500 Ohm/12 V or 1 000 Ohm/24 V

MEASURED DATA RECORD

Type RTC: time-controlled logging of measured data into instrument memory, allows to log up to 250 000 values
 Type FAST: fast data logging into instrument memory, allows to log up to 8 000 values at a rate of 40 records/s
 Transmission: via data output RS 232/485 or via OM Link

POWER SUPPLY

Options: 10...30 V AC/DC, 10 VA, isolated,
 - fuse inside (T 4000 mA)
 80...250 V AC/DC, 10 VA, isolated
 - fuse inside (T 630 mA)

MECHANIC PROPERTIES

Material: Noryl GFN2 SE1, incomcombustible UL 94 V-I
 Dimensions: 96 x 48 x 120 mm
 Panel cut-out: 90,5 x 45 mm

OPERATING CONDITIONS

Connection: connector terminal board, conductor cross-section <1,5 mm² / <2,5 mm²
 Stabilisation period: within 15 minutes after switch-on
 Working temp.: 0°...60°C
 Storage temp.: -10°...85°C
 Cover: IP65 (front panel only)
 Construction: safety class I
 Overvoltage category: EN 61010-1, A2
 Insulation resistance: for pollution degree II, measurement category III
 instrum.power supply > 670 V (PI), 300 V (DI)
 Input/output > 300 V (PI), 150 (DI)
 EMC: EN 61000-3-2+A12; EN 61000-4-2, 3, 4, 5, 8, 11;
 EN 550222, A1, A2

***Table of measuring rate on one channel, according to setting of input mode and type of measurement*

Channels/Rate	40	20	10	5	2	1	0,5	0,2	0,1
Input mode > SWITCH - single channel measurement	40,00	20,00	10,00	5,00	2,00	1,00	0,50	0,20	0,10
Input mode > SWITCH - dual channel measurement	6,667	3,333	1,667	1,25	0,714	0,417	0,227	0,096	0,049
Input mode > CYCLE - 2x single channel meas.	6,667	3,333	1,667	1,25	0,714	0,417	0,227	0,096	0,049
Input mode > CYCLE - 1x single + 1x dual channel measurement	4,444	2,222	1,111	0,833	0,476	0,278	0,152	0,064	0,033
Input mode > CYCLE - 2x dual channel measurement	3,333	1,667	0,833	0,625	0,357	0,208	0,114	0,048	0,025

Measuring rate in the menu is indicated for mode SWITCH and single channel measurement.

Single channel measurement > DC, PM, DU, OHM - 2/4 wire, Pt - 2/4 wire, Ni - 2/4 wire, Cu - 2/4 wire, TC on 1st input with external compensation, TC on other inputs

Dual channel measurement > OHM - 3 wire, Pt - 3 wire, Ni - 3 wire, Cu - 3 wire, TC on 1st input with internal compensation

If at least one TC measurement with internal compensation is to be used, IT HAS TO BE connected on 1st input. Cold junction value is measured here!

The instrument contains up to 4 A/D converters that always control one pair of inputs 1. + 2., 3. + 4., 5 + 6., 7. + 8. Converters measure almost simultaneously.

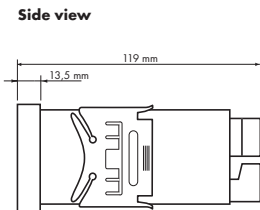
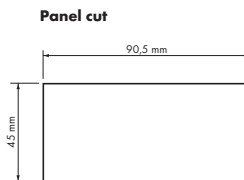
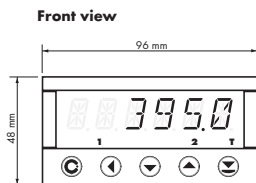

Panel thickness: 0,5...20 mm

Instrument installation

1. insert the instrument into the panel cut-out
2. fit both travellers on the box
3. press the travellers close to the panel

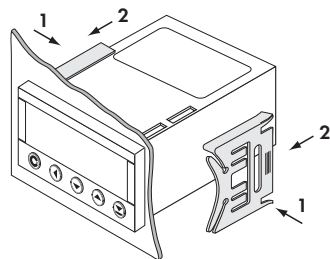
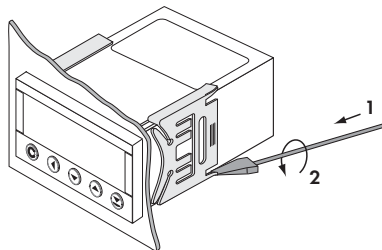

Instrument disassembly

1. slide a screw driver under the traveller wing
2. turn the screw driver and remove the traveller
3. take the instrument out of the panel

Product **OMU 408**
 Type
 Manufacturing No.
 Date of sale

GUARANTEE

A guarantee period of 60 months from the date of sale to the user applies to this instrument.
 Defects occurring during this period due to manufacture error or due to material faults shall be eliminated free of charge.

For quality, function and construction of the instrument the guarantee shall apply provided that the instrument was connected and used in compliance with the instructions for use.

The guarantee shall not apply to defects caused by:

- mechanic damage
- transportation
- intervention of unqualified person incl. the user
- unavoidable event
- other unprofessional interventions

The manufacturer performs guarantee and post.guarantee repairs unless provided for otherwise.

Y E A R S

Stamp, signature

DECLARATION OF CONFORMITY

Company: **ORBIT MERRET, spol. s r.o.**
Klánská 81/141, 142 00 Prague 4, Czech Republic, IDNo: 00551309

Manufactured: **ORBIT MERRET, spol. s r.o.**
Vodňanská 675/30, 198 00 Prague 9, Czech Republic

declares at its full responsibility that the product presented hereunder meets all technical requirements, is safe for use when utilised under the terms and conditions determined by ORBIT MERRET, spol.s r.o. and that our company has taken all measures to ensure conformity of all products of the type listed hereunder, which are being brought out to the market, with technical documentation and requirements of the appurtenant statutory orders.

Product: 4-digit programmable panel instrument

Type: **OMU 408**

Conformity is assessed pursuant to the following standards:

El. safety:	EN 61010-1
EMC:	EN 50131-1, chapter 14 and chapter 15
	EN 50130-4, chapter 7
	EN 50130-4, chapter 8
	EN 50130-4, chapter 9
	EN 50130-4, chapter 10
	EN 50130-4, chapter 11
	EN 50130-4, chapter 12
	EN 50130-4, chapter 13
	EN 50130-5, chapter 20
	prEN 50131-2-1, par. 9.3.1
	EN 61000-4-8
	EN 61000-4-9
	EN 61000-3-2 ed. 2:2001
	EN 61000-3-3: 1997, Cor. 1:1998, Z1:2002
	EN 55022, chapter 5 and chapter 6

and Ordinance on:

El. safety:	No. 168/1997 Coll.
EMC:	No. 169/1997 Coll.

The evidence are the protocols of authorized and accredited organizations:

VTÚE Praha, experimental laboratory No. 1158, accredited by ČIA
VTÚPV Vyškov, experimental laboratory No. 1103, accredited by ČIA

Place and date of issue: Prague, 18. March 2006

Miroslav Hackl v.r.
Company representative

Mode of asses. of conformity §12, par. 4 b, d Act No. 22/1997 Coll.