

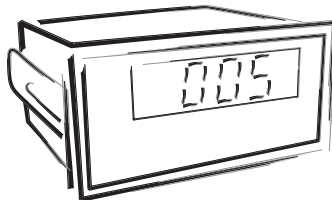

OM 36

3 1/2 DIGIT

DC VOLTMETER/AMMETER
AC VOLTMETER/AMMETER
PROCESS MONITOR
OHMMETER
THERMOMETER FOR PT 100



SAFETY INSTRUCTIONS

Please, read the enclosed safety instructions carefully and observe them!
These instruments should be safeguarded by isolated or common fuses (breakers)!
For safety information the EN 61 010-1 + A2 standard must be observed.
This instrument is not explosion-safe!

TECHNICAL DATA

Measuring instruments of the OM 36 series conform to European regulation 89/336/EWG and Ordinance 168/1997 Coll.

They are up to the following European standards:

EN 55 022, class B

EN 61000-4-2, -4, -5, -6, -8, -9, -10, -11

The instruments are applicable for unlimited use in agricultural and industrial areas.

CONNECTION

Power supply from the main line has to be isolated from the measuring leads.



ORBIT MERRET, spol. s r.o.

Vodňanská 675/30
198 00 Praha 9
Czech Republic

Tel: +420 - 281 040 200
Fax: +420 - 281 040 299
e-mail: orbit@merret.cz
www.orbit.merret.cz



1. CONTENTS

| | | |
|----|---|----|
| 1. | Contents | 3 |
| 2. | Instrument description | 4 |
| 3. | Connection | 5 |
| 4. | Setting | 6 |
| | Setting the decimal point | 6 |
| | 4.1 Change of projection on the display | 7 |
| | 4.2 Setting the excitation | 10 |
| 5. | Technical data | 12 |
| 6. | Instrument dimensions and installation | 13 |
| 7. | Declaration of conformity | 14 |
| 8. | Certificate of guarantee | 15 |

2. INSTRUMENT DESCRIPTION

DESCRIPTION

The OM 36 model series are simple 3 1/2 digit panel instruments, which are manufactured in the following alternatives:

| | |
|-----|--------------------------------|
| DC | DC voltmeter/ammeter |
| AC | AC voltmeter/ammeter |
| PM | Process monitor |
| OHM | Ohmmeter |
| RTD | Thermometer for sensors Pt 100 |

The instrument is based on a simple converter, which secures high accuracy and stability.

ADJUSTABLE DISPLAY PROJECTION

| | |
|------------|---|
| Setting | by potentiometers under the front panel (in the range of approx. $\pm 10\%$) |
| Projection | ± 1999 |

OPERATION

The instrument is designed for simple measurement without further control.

Placement of the decimal point is selectable by shorting link under the front panel.

EXTENSION

Excitation is suitable for feeding of sensors and transducers. It has a galvanic isolation with continuously adjustable value in the range of 2...24 VDC.

Analogue outputs will find their place in applications where further evaluating or processing of measured data in external devices is required. We offer several types of current or voltage non-isolated outputs. The value of analogue output corresponds with the input signal.

3. CONNECTION

The supply lead for feeding the instrument should not be in the proximity of low-potential signals.

Contactors, motors with larger input and other efficient elements should not be in the proximity of the instrument.

The lead into the instrument input (the measured quantity) should be in sufficient distance from all power leads and appliances. Provided this cannot be secured, it is necessary to use shielded leads with connection to ground.

The instruments are tested in compliance with standards for use in industrial area, yet, we recommend to abide by the above mentioned principles.

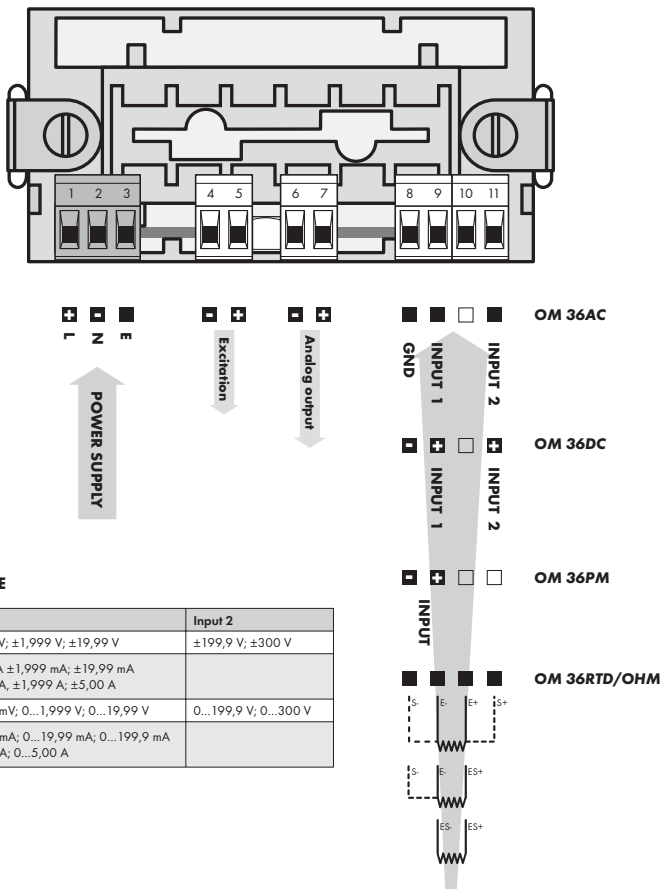

4. INSTRUMENT SETTING

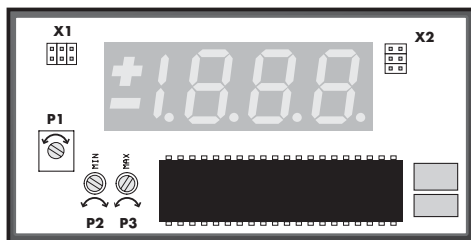

Jumper X1, Decimal point

| | | | | |
|---|---|---|-------|-------|
| 1 | 2 | 3 | 1 - 1 | X,xxx |
| 1 | 2 | 3 | 2 - 2 | XX,xx |
| 1 | 3 | 3 | 3 - 3 | XXX,x |

Jumper X2, measuring rate

| | | | | |
|---|---|---|-------|---------|
| 1 | 2 | 6 | 1 - 2 | 1,2 m/s |
| 1 | 3 | 6 | 5 - 6 | 2,5 m/s |
| 3 | 2 | 4 | 2 - 3 | 5 m/s |
| 3 | 3 | 4 | 5 - 4 | 10 m/s |

ADJUSTING ELEMENTS

- after removing the top cover frame the following settings are accessible
- decimal point - may be adjusted by shorting links

P1 setting the display brightness

P2 setting the zero

- in the DC and AC types it does not always have to be fixed
- in the RTD and OHM types this trimmer is used for compensation of conduct resistance

P3 setting the full range

- nastavení zobrazení displeje (cca ± 10 %)

X1 setting the decimal point

- by jumper

X2 setting the measuring rate

- by jumper

4.1 CHANGE OF PROJECTION ON THE DISPLAY

The measuring range and projection of the display are set from manufacture pursuant to customer requirements stated in the order form for which the manufacturer declares validity of the catalogue technical parameters.

Under certain conditions, i.e. the expertise and technical equipment, the change in instrument parameters may be performed pursuant to the following procedure.

SOLDERING JUMPERS

| Type | Range | Counting the input divider | J1 | J2 | J3 | J4 |
|--------|----------|---|------|------|-----|------|
| I | < 90 mA | Shunt R_7 with loss 200 mV or resistances R_8, R_{11} | link | link | | |
| I | < 5 A | R_8, R_{11} for shunt R_7 - loss 200 mV | | link | | |
| U | < 200 mV | Set by changing $R_8 = 750$ Ohm, without R_8, R_{11} | | link | | |
| U | < 60 V | R_8, R_{11} | | | | |
| U | < 300 V | R_1, R_8, R_9 remove link B | | | | |
| Pt 100 | | Without R_{12}, R_{27}, R_{11} , remove link A | | | cut | link |

WIRING DIAGRAM

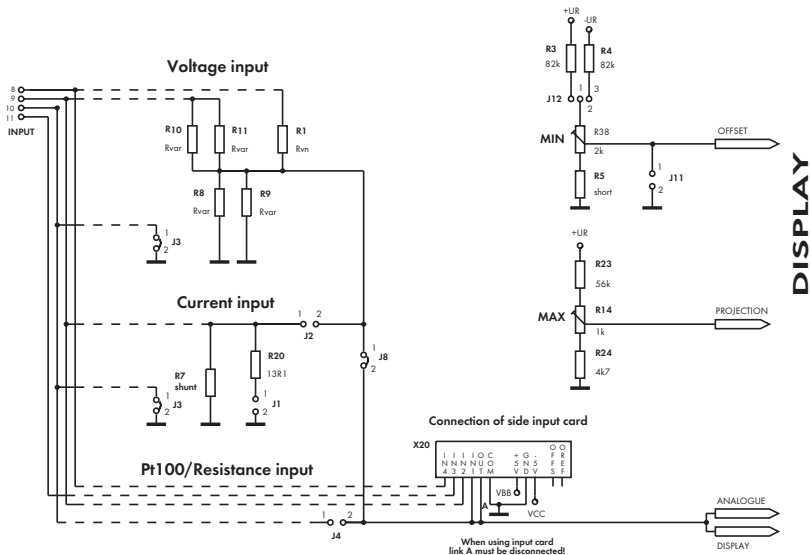

CHANGE OF PROJECTION RANGEVoltage Input < 60 V- R_8 has value of 1 MOhm

$$R_{10} = \frac{R_8 \times (D_{\max} - D_{\min})}{10\,000 \times (U_{\max} - U_{\min}) - (D_{\max} - D_{\min})}$$

Voltage Input > 60 V- R_8 has value of 1,22 MOhm, 2x 511 kOhm in series

$$R_{10} = \frac{R_1 \times (D_{\max} - D_{\min})}{10\,000 \times (U_{\max} - U_{\min}) - (D_{\max} - D_{\min})}$$

Current Input

$$R_7 = \frac{D_{\max} - D_{\min}}{10\,000 \times (I_{\max} - I_{\min})}$$

Zero offset

$$R_5 = 2\,000 \times \frac{P_{od}}{P_{do} - P_{od}}$$

$$R_3 = \frac{24\,600\,000}{P_{do} - P_{od}} - 2\,000 - R_5$$

 R_8 may be replaced by series/parallel combination of two resistances R_8 a R_9

$$R_8 = \frac{R_8 \times R_9}{R_8 + R_9}$$

 R_{10} may be replaced by series/parallel combination of two resistances R_{10} a R_{11}

$$R_{10} = \frac{R_{10} \times R_{11}}{R_{10} + R_{11}}$$

ZERO OFFSET - SOLDERING JUMPERS

| Jumper | Offset |
|--------------------------|----------|
| J11 - link | none |
| J12 - link, to connector | negative |
| J12 - link, to display | positive |

LEGEND

| | |
|-----------------------------|---|
| $R_{g\ 9}$ and $R_{10\ 11}$ | resistances of input divider for range < 60 V |
| R_1 and $R_{g\ 9}$ | resistances of input divider for range > 60 V |
| $R_{3(4)'\ 5}$ | resistances for zero offset, R_5 is, as a standard, replaced by short-circuit |
| P_{odr} , P_{do} | offset values (in divisions 0...1999) for extreme positions of the potentiometer „ MIN” |
| U_{min} | minimum value of input voltage (in Volts) |
| U_{max} | maximum value of input voltage (in Volts) |
| D_{min} | minimum value on display (in divisions) |
| D_{max} | maximum value on display (in divisions) |
| I_{min} | minimum value of input current (in Amperes) |
| I_{max} | maximum value of input current (in Amperes) |

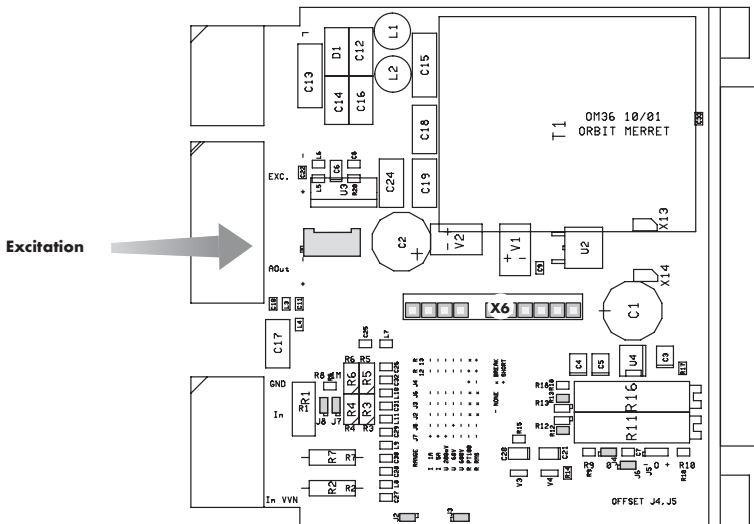

4.2 SETTING THE EXCITATION

Excitation is, as a standard, set for 24 VDC.

Change in adjustment of the excitation value is performed by trimmer located over the terminal boards of the instrument (see picture).

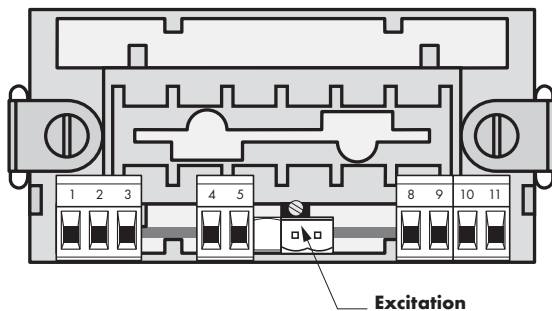

5. TECHNICAL DATA

MEASURING RANGE

the range is fixed, according to order

| | | |
|-----------|----------|---------|
| ±199,9 mV | 1 MOhm | DC |
| ±1,999 V | 1 MOhm | Input 1 |
| ±19,99 V | 1 MOhm | Input 1 |
| ±199,9 V | 1 MOhm | Input 2 |
| ±300 V | 2 MOhm | Input 2 |
| ±199,9 µA | < 260 mV | Input 1 |
| ±1,999 mA | < 260 mV | Input 1 |
| ±19,99 mA | < 260 mV | Input 1 |
| ±199,9 mA | < 200 mV | Input 1 |
| ±1,999 A | < 200 mV | Input 1 |
| ±5,00 A | < 50 mV | Input 1 |

the range is fixed, according to order

| | | |
|--------------|----------|---------|
| 0...199,9 mV | 1 MOhm | AC |
| 0...1,999 V | 1 MOhm | Input 1 |
| 0...19,99 V | 1 MOhm | Input 1 |
| 0...199,9 V | 1 MOhm | Input 2 |
| 0...300 V | 2 MOhm | Input 2 |
| 0...1,999 mA | < 260 mV | Input 1 |
| 0...19,99 mA | < 260 mV | Input 1 |
| 0...199,9 mA | < 200 mV | Input 1 |
| 0...1,999 A | < 200 mV | Input 1 |
| 0...5,00 A | < 50 mV | Input 1 |

Frequency range: 40...2 500 Hz

the range is fixed, according to order

| | | |
|-----------|----------|----|
| 0...5 mA | < 260 mV | PM |
| 0...20 mA | < 260 mV | |
| 4...20 mA | < 260 mV | |
| ±2 V | 1 MOhm | |
| ±5 V | 1 MOhm | |
| ±10 V | 1 MOhm | |

the range is fixed, according to order

| | | |
|----------------|--|-----|
| 0...199,9 Ohm | | OHM |
| 0...1,999 kOhm | | |
| 0...19,99 kOhm | | |
| 5...105 Ohm | | |

Connection: 2 or 4 wire

the range is fixed, according to order

| | | |
|-------------|---------------------------------------|-----|
| Pt xxx | ±199,9°C or -200...850°C | RTD |
| Type Pt: | 100/500/1 000 Ohm, platinum, 3850 ppm | |
| Connection: | 2, 3 or 4 wire | |

PROJECTION

| | |
|----------------|---|
| Display: | ±1999, red or green LED, digit height 14 mm |
| Decimal point: | adjustable by jumper |
| Brightness: | adjustable by potentiometer under the front panel |

INSTRUMENT ACCURACY

| | | |
|--------------------|--|-----|
| TC: | 100 ppm/°C | |
| Accuracy: | ±0,1 % of range | |
| | ±0,3 % of range (< 100 Hz, crest faktor 1:2) | AC |
| | ±0,2 % of range | OHM |
| | | RTD |
| Resolution: | 0,1° or 1°C | |
| Rate: | 1,2 - 2,5 - 5 - 10 measurements/s | |
| Overload capacity: | 10x (t < 100 ms) - not for 5 A and 300 V | |
| | 2x (long-term) | |
| Calibration: | at 25°C and 40 % r.h. | |

ANALOGUE OUTPUTS

| | |
|---------------|--|
| Type: | non-isolated, the output corresponds with the input signal |
| Nonlinearity: | 0,3 % of range |
| TC: | 100 ppm/°C |
| Rate: | response to change of value < 100 ms |
| Voltage: | 0...2 V, 0...5 V, 0...10 V |
| Current: | 0...5/20 mA/4...20 mA - compensation of conduct up to 600 Ohm |

EXCITATION

| | | |
|-------------|----------------------------|----------|
| Adjustable: | 2...24 VDC/50 mA, isolated | DC/AC/PM |
|-------------|----------------------------|----------|

POWER SUPPLY

| |
|--------------------------------------|
| 24/110/230 VAC, 50/60 Hz, 5 VA, ±10% |
| 12...24 VDC, max. 150 mA |
| 12...30 VDC, max. 300 mA, isolated |

MECHANIC PROPERTIES

| | |
|----------------|---|
| Material: | Naryl GFN2 SE1, incombustible UL 94 V-I |
| Dimensions: | 96 x 48 x 110 mm |
| Panel cut-out: | 92 x 45 mm |

OPERATING CONDITIONS

| | |
|-----------------------|--|
| Connection: | con. terminal board, conductor section up to 2,5 mm ² |
| Stabilization period: | within 15 minutes after switch-on |
| Working temp.: | 0°...50°C |
| Storage temp.: | -10°...85°C |
| Shielding: | IP42, upon request IP64 - front panel only |
| Construction: | safety class I |
| Overvoltage cat.: | EN 61010-1, A2 |
| | III. - instrument power supply (300 V) |
| | II. - input, output, excitation (300 V) |
| | for pollution degree II |
| EMC: | EN 61000-3-2+A12; EN 61000-4-2, 3, 4, 5, 8, 11; EN 550222, A1, A2 |

6. INSTRUMENT DIMENSIONS

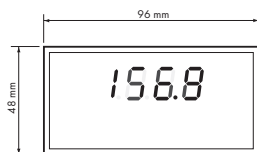
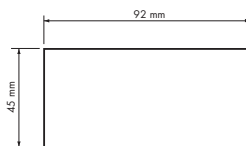
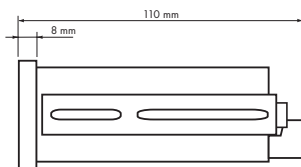
Front view**Panel cut****Side view**

Panel thickness: 0,5...8 mm

7. DECLARATION OF CONFORMITY

Company: ORBIT MERRET, spol.s r.o. (Ltd.)
 Klánova 81/141
 142 00 Prague 4
 Czech Republic
 IDNo: 00551309

Manufactured: ORBIT MERRET, spol.s r.o. (Ltd.)
 Vodňanská 675/30
 198 00 Prague 9
 Czech Republic

declares at its full responsibility that the product presented hereunder meets all technical requirements, is safe for use when utilised under the terms and conditions determined by ORBIT MERRET, spol.s r.o. and that our company has taken all measures to ensure conformity of all products of the type listed hereunder, which are being brought out to the market, with technical documentation and requirements of the appurtenant statutory orders.

Product: 3 1/2 - digit programmable panel instrument

Type: OM 36, in versions: DC, AC, PM, OHM, RTD

Mode of asses. of conformity: §12, par. 4 b, d of Act No.22/1997 Sb.

Conformity is assessed pursuant to the following standards::

Electrical safety: EN 61010-1
 EMC: EN 50131-1, par. 14 and par. 15
 EN 55022
 EN 61000-3-2 + A12, Cor. 1, change A1, change A2
 EN 61000-4-2
 EN 61000-4-3
 EN 61000-4-4
 EN 61000-4-5
 EN 61000-4-6
 EN 61000-4-8
 EN 61000-4-11, par. 5.1 and par. 5.2

and government ordinance:

Electrical safety: No. 168/1997 Sb.
 EMC: No. 169/1997 Sb.

The evidence are the protocols of authorized and accredited organization:

VTÚE Praha, experimental laboratory No. 1158 accredited by ČIA, o.p.s. with EN ISO/IEC 17025

Place and date of issue: Prague, 14. januar 2001

Miroslav Hackl
 Company representative

8. CERTIFICATE OF GUARANTEE

Product **OM 36** DC AC PM OHM RTD
 Type
 Manufacturing No.
 Date of sale

A guarantee period of 24 months from the date of sale to the user applies to this instrument.
 Defects occurring during this period due to manufacture error or due to material faults shall be eliminated free of charge.

For instrument quality, function and construction the guarantee shall apply provided that the instrument was connected and used in compliance with the instruction for use.

The guarantee shall not apply for defects caused by:

- mechanic damage
- in transport
- intervention of unqualified person incl. the user
- unavoidable event
- other unprofessional interventions

The manufacturer performs the guarantee and post-guarantee repairs unless provided for otherwise.

Stamp, signature

ORBIT MERRET, spol. s r.o.

Vodnanska 675/30
198 00 Prague 9
Czech Republic

tel: +420 - 281 040 200
fax: +420 - 281 040 299
e-mail: orbit@merret.cz
www.orbit.merret.cz

Austria

ING.E. GRUBER GmbH
Edu. Kittenberger Gasse 97 Top2
A-1230 Wien
tel: +43 - 1 - 869 23 39-0
fax: +43 - 1 - 865 18 75
e-mail: office@gruber-components.at
www.gruber-components.at

The Netherlands

AE SENSORS B.V.
J. Valsterweg 92
3301 AB Dordrecht
tel: +31 - 78 - 621 31 52
fax: +31 - 78 - 621 31 46
e-mail: aesensors@aesensors.nl
www.aesensors.nl

Switzerland

ORBIT CONTROLS AG
Zürcherstrasse 137
8952 Schlieren
tel: +41 - 1 - 730 27 53
fax: +41 - 1 - 730 27 83
e-mail: info@orbitcontrols.ch
www.orbitcontrols.ch

USA

METRIX Instruments Co.
1711 Townhurst Dr.
Houston, Texas 77043-2899
tel: +1 - 713 - 461 21 31
fax: +1 - 713 - 461 82 83
e-mail: sales@metrix1.com
www.metrix1.com

Germany

MEGATRON Elektronik AG & Co.
Hermann-Oberth-Str. 7
85640 Putzbrunn/München
tel: +49 - 89 - 460 94 - 0
fax: +49 - 89 - 460 941 01
e-mail: sales@megatron.de
www.megatron.de

Russian Federation

ПО Интерфейс
Россия, 350020, Краснодар
ул.Шоссе Нефтяников, 9/1
тел.: (861) 215 41 44
факс: (861) 215 41 44
e-mail: import@bk.ru
www.orbit.merret.ru

Turkey

ALFA ELEKTRONIK Ltd.
Baglarbasi Mah. Ergenekon No: 33
TR - 81540 Maltepe - ISTANBUL
tel: +90 - 216 - 442 39 49
fax: +90 - 219 - 305 54 50
e-mail: sb@elmak.com.tr
www.alfa-technik.com

Lithuania

RIFAS UAB
Tinklų g. 29a
LT-5300 Panevėžys
tel: +370 - 5 - 510 400
fax: +370 - 5 - 582 729
e-mail: sales@metrix1.com
www.metrix1.com

Slovakia

TECHREG, s.r.o.
Dukelských hrdinov 2
984 22 Lučenec
tel: +421 - 47 - 433 15 92
fax: +421 - 47 - 433 15 92
e-mail: techreg@bb.psg.sk
www.techreg.sk

Ukraine

ООО <KOTRIS>
Nesterova 3, Office 907
030 57 Kyjev
tel: +44 - 446 - 21 42
fax: +44 - 446 - 21 42
e-mail: metrix-ua@svitonline.com